

006

007

008

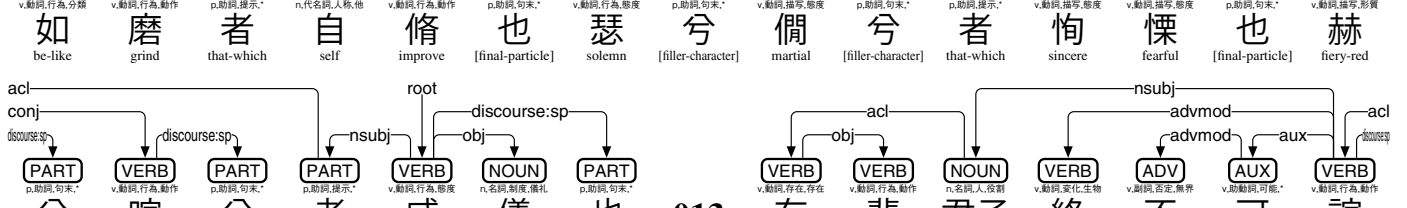
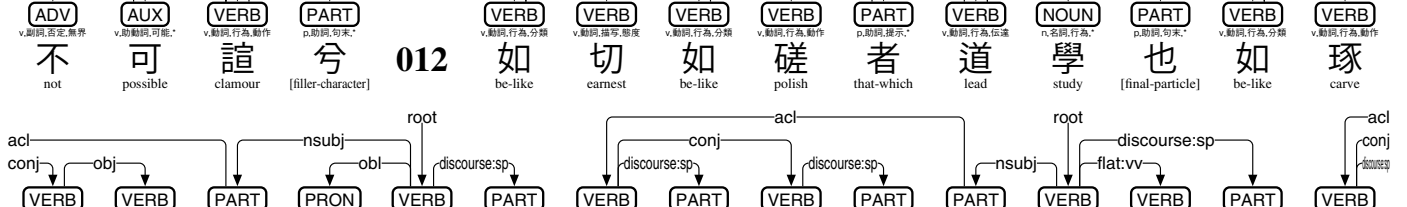
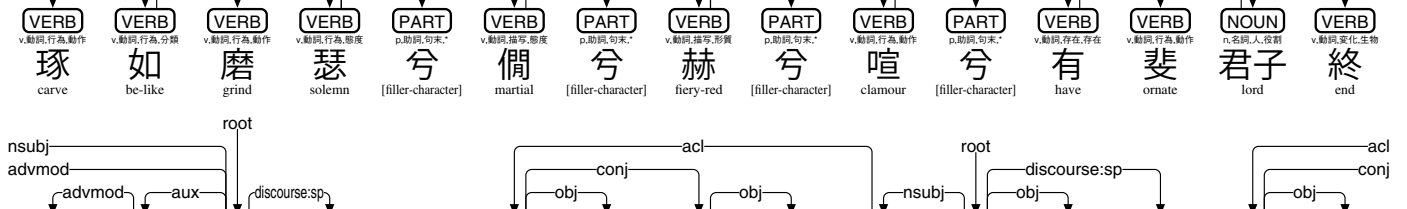
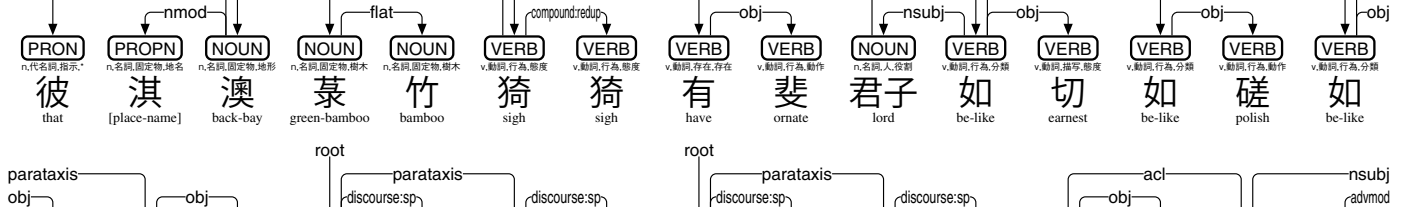
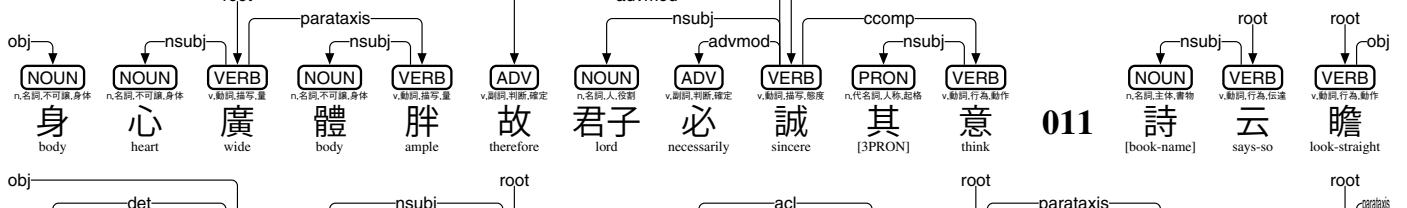
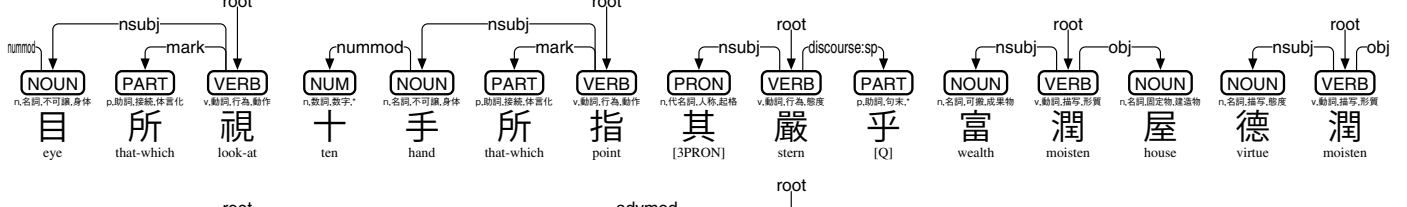
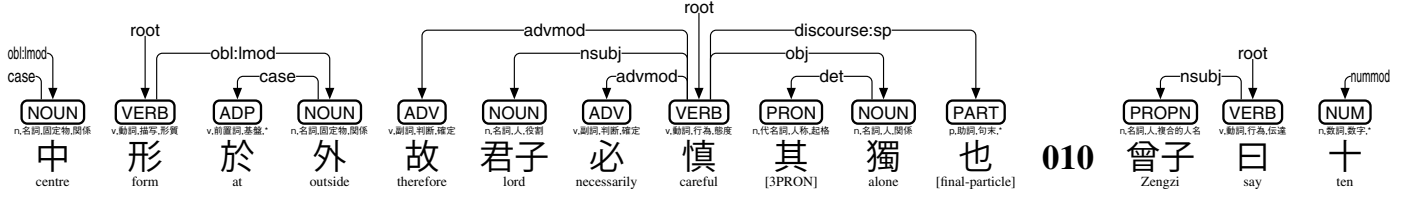
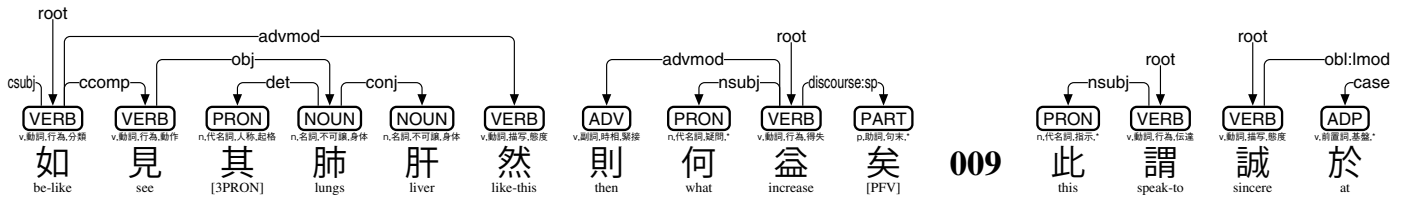
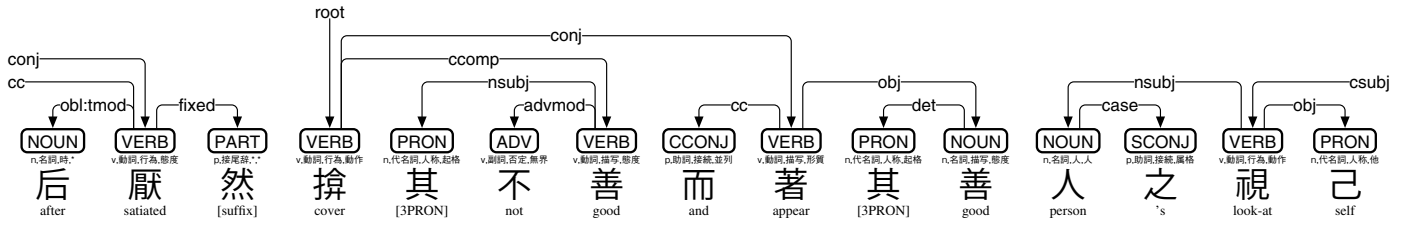

009

010

011

012

013

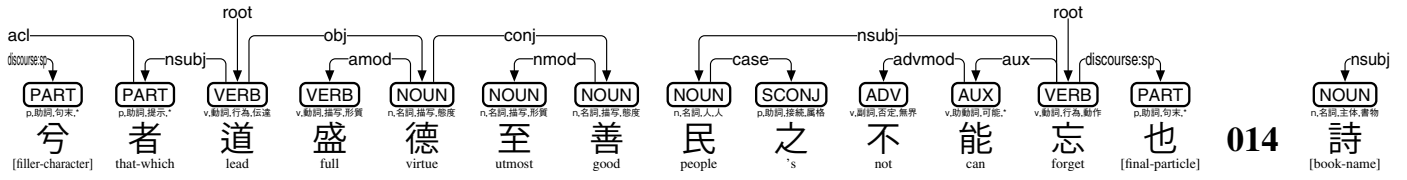

014

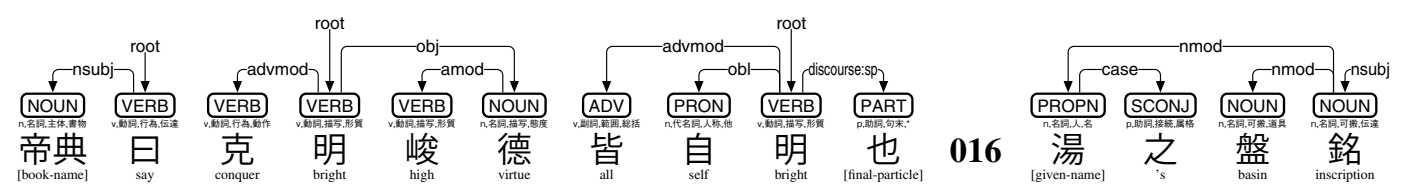
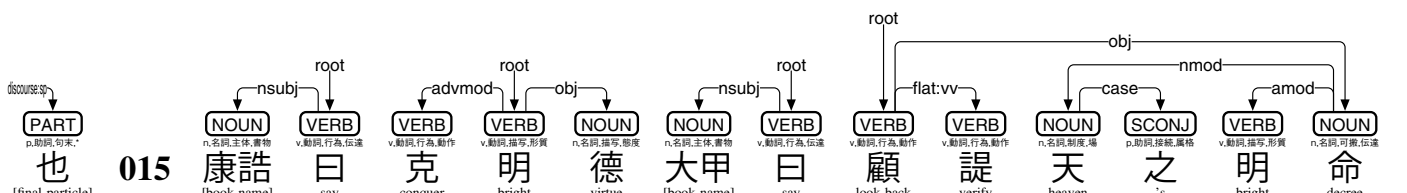
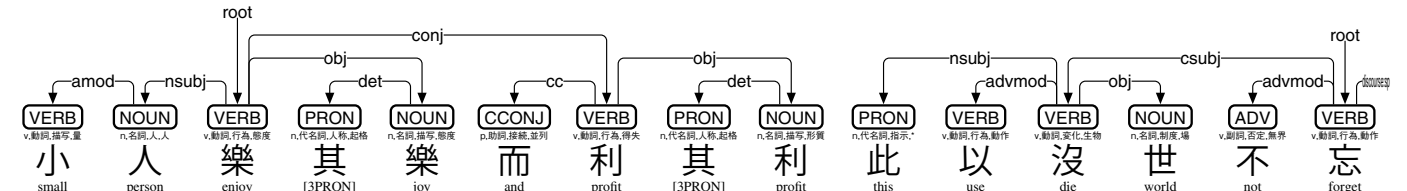
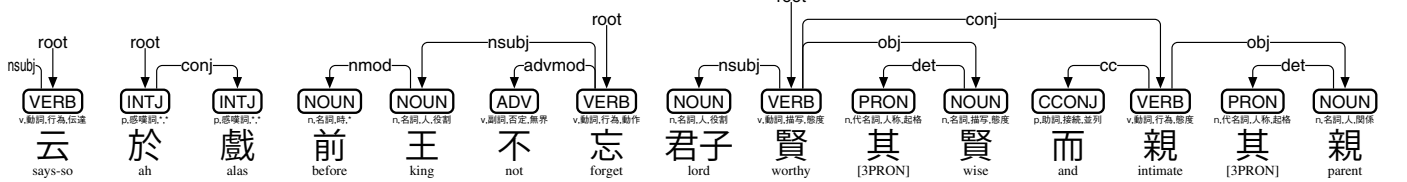

016

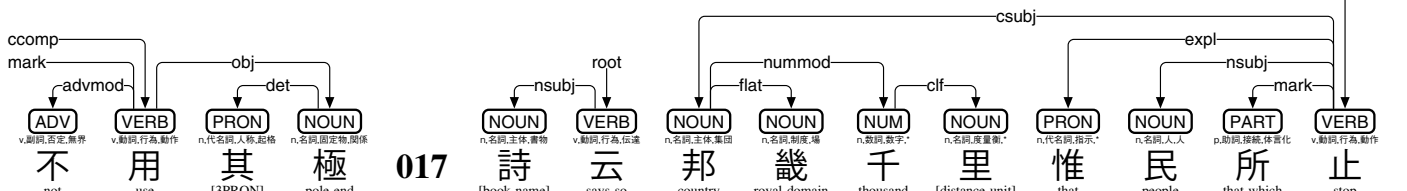
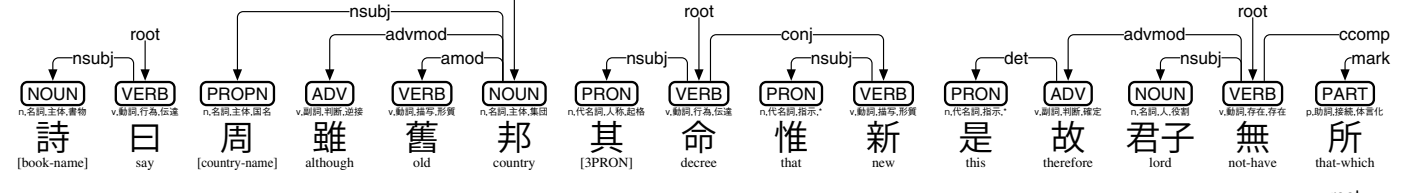
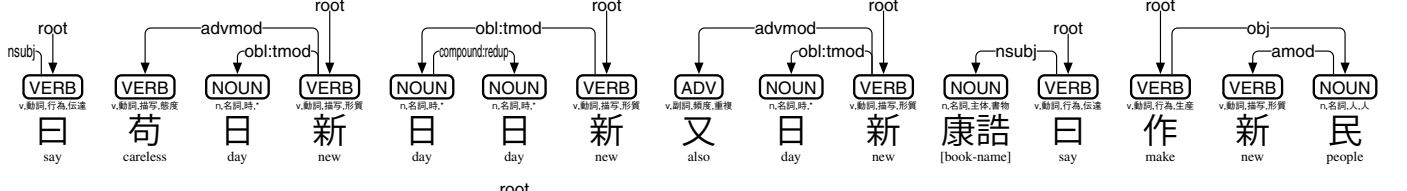

017

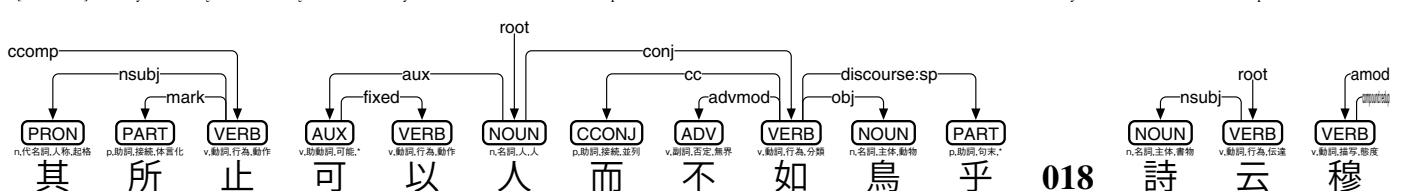
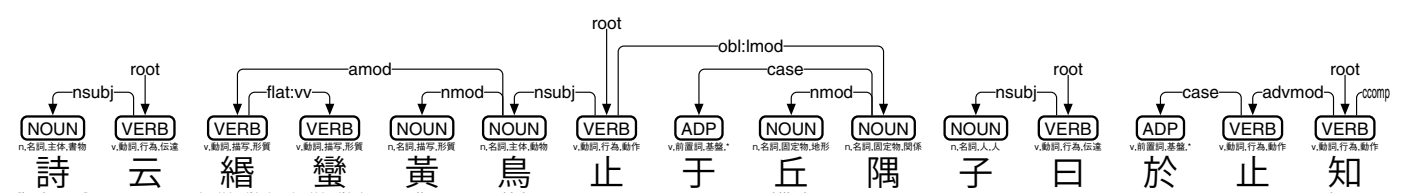

018



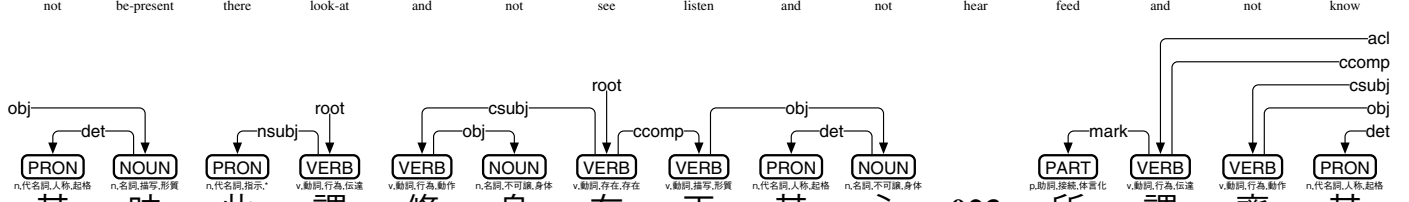
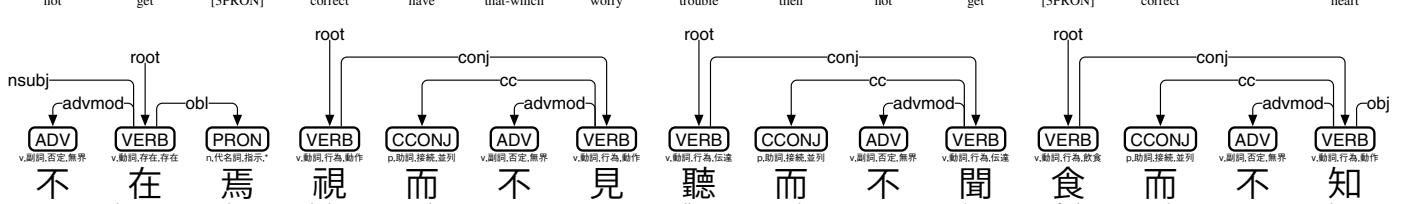
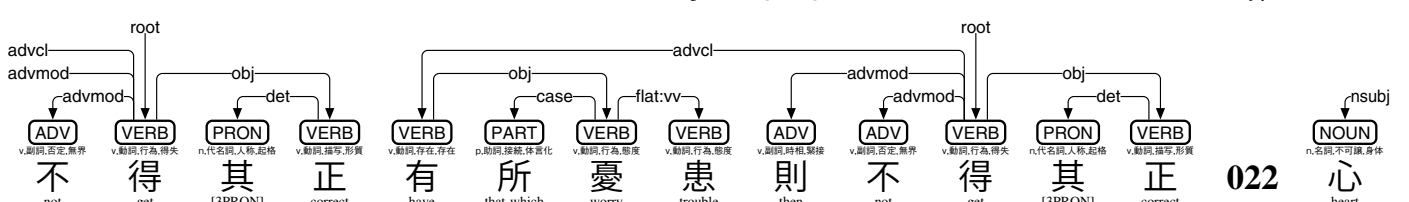
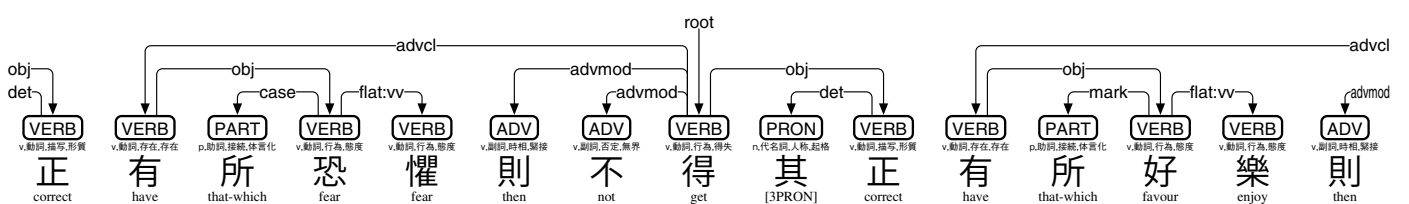
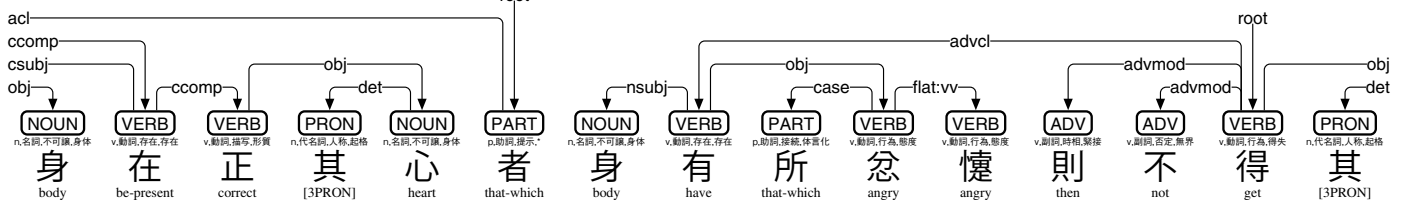
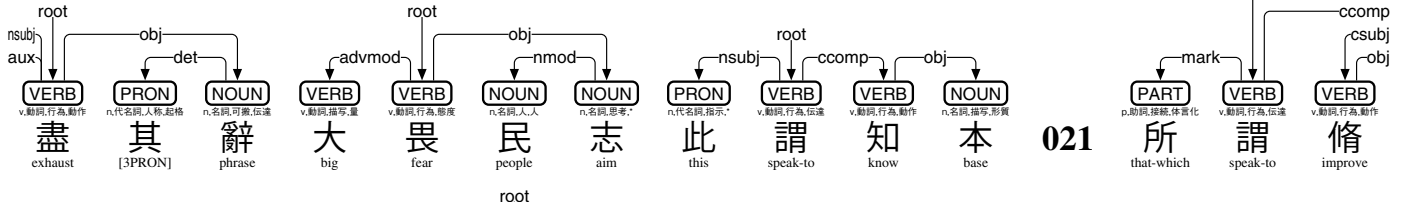
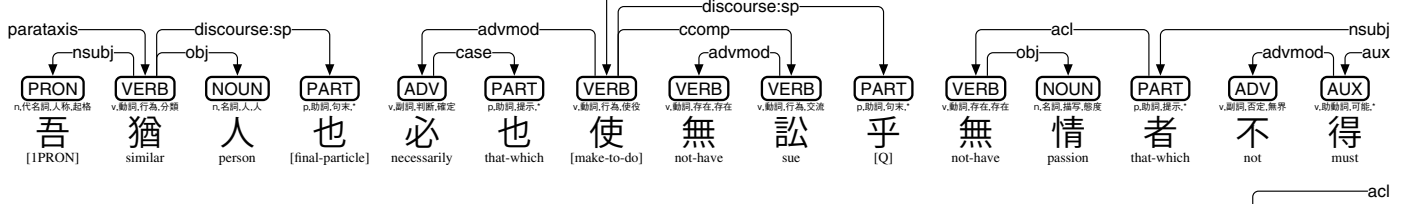
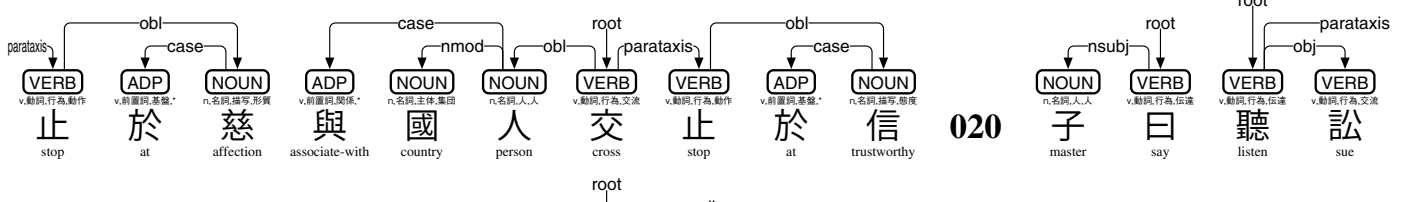
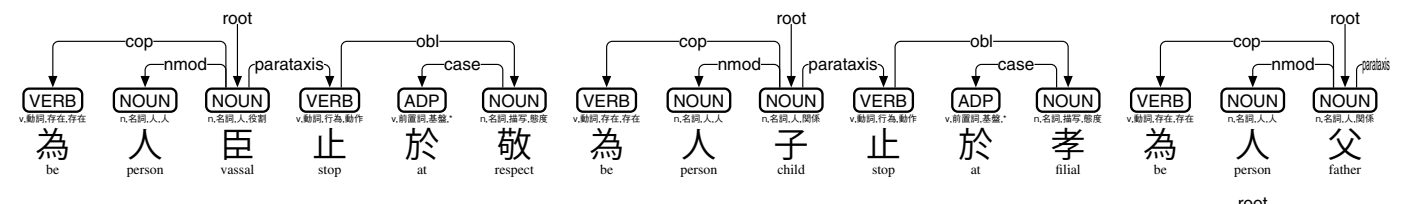
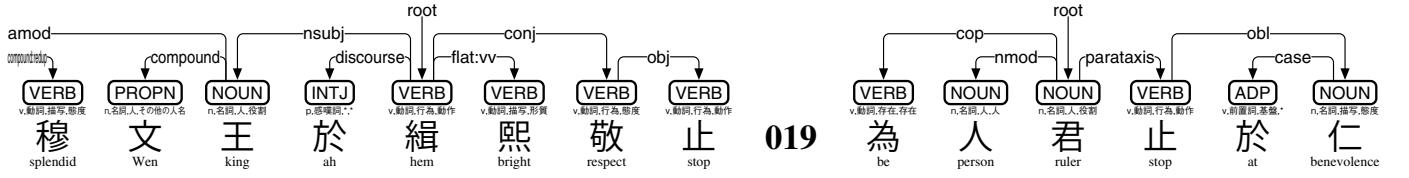

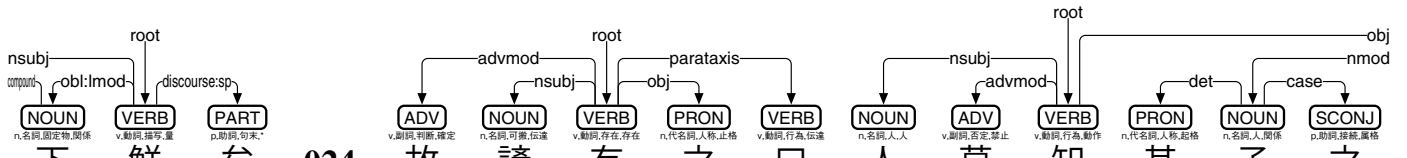
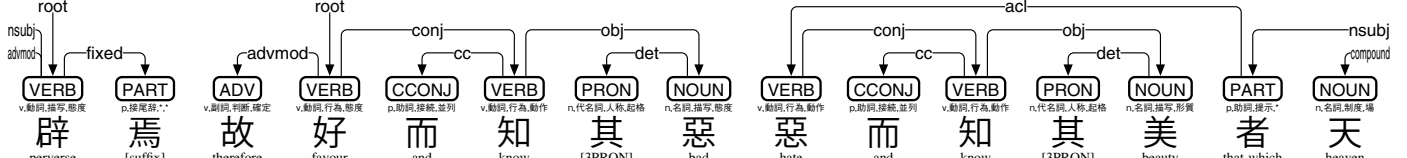
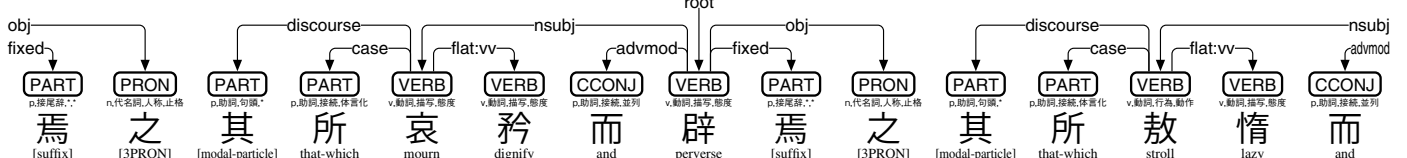
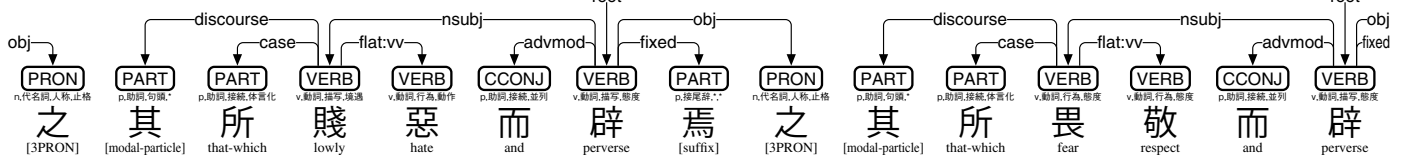
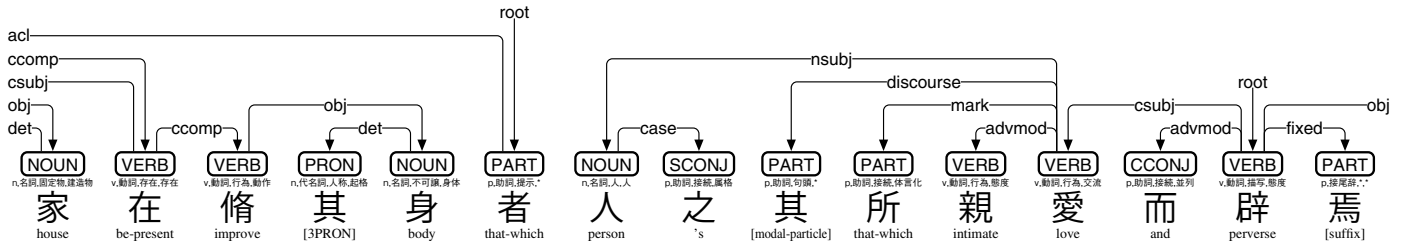

024

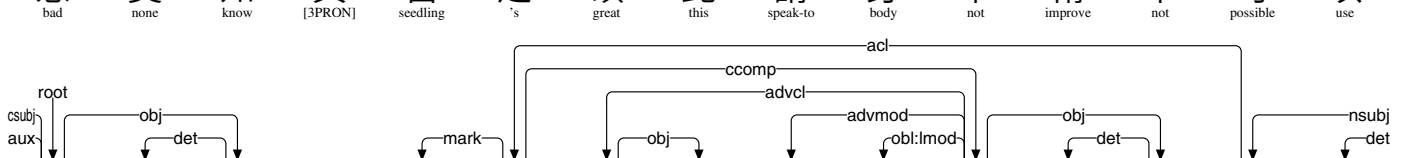
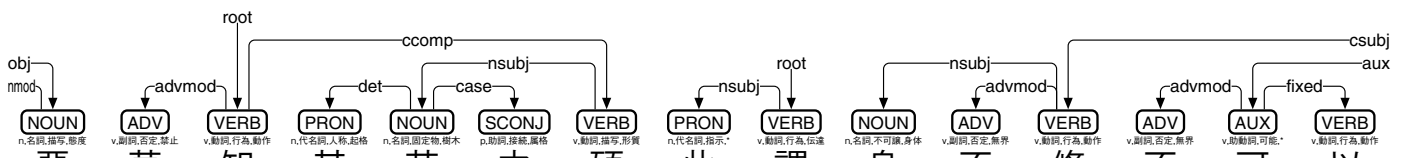

025

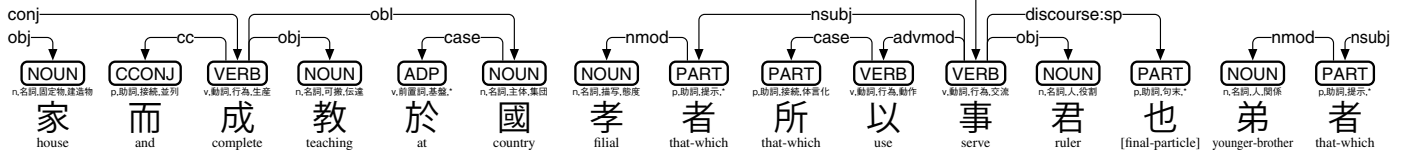
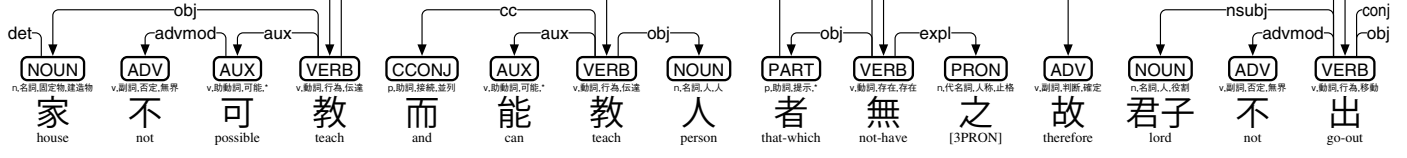

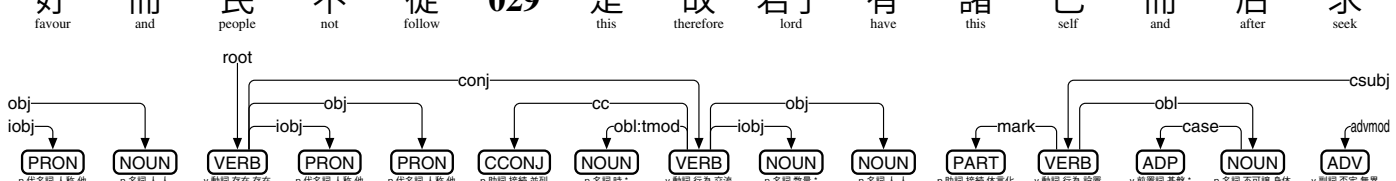
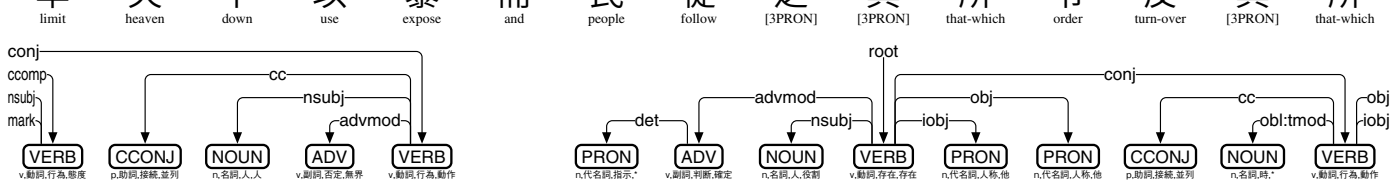
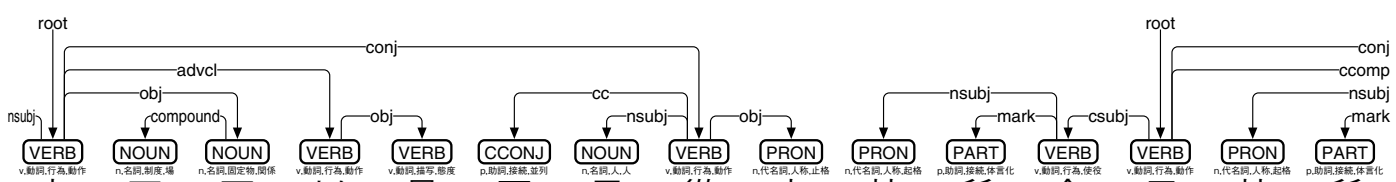
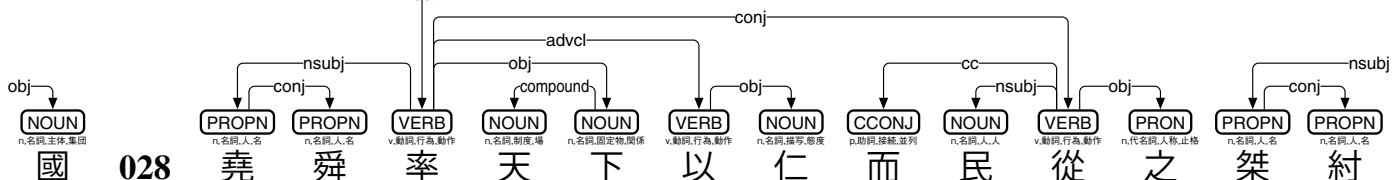
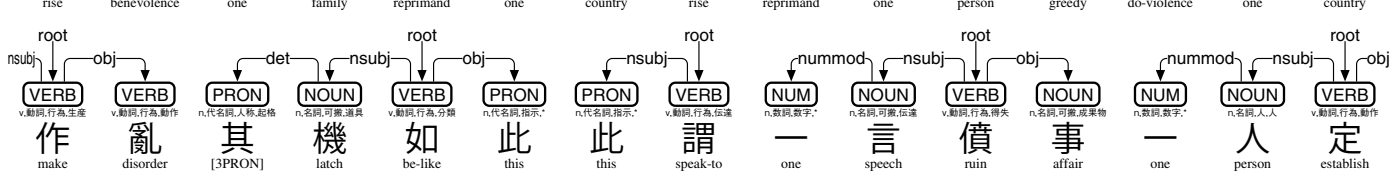
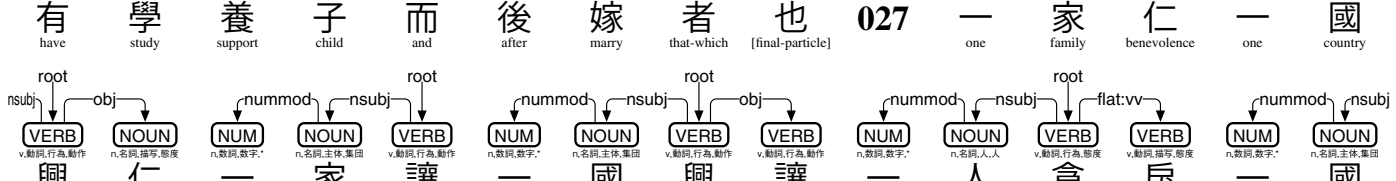
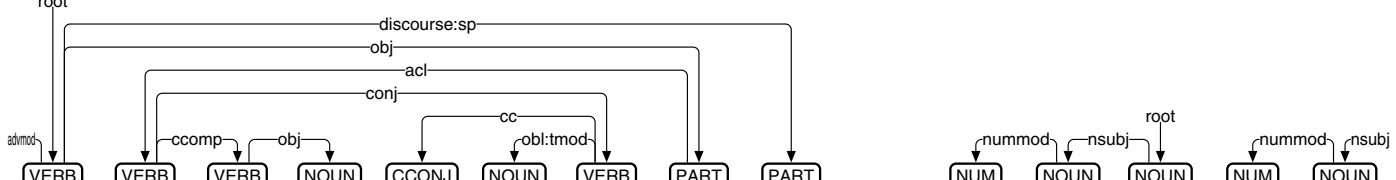
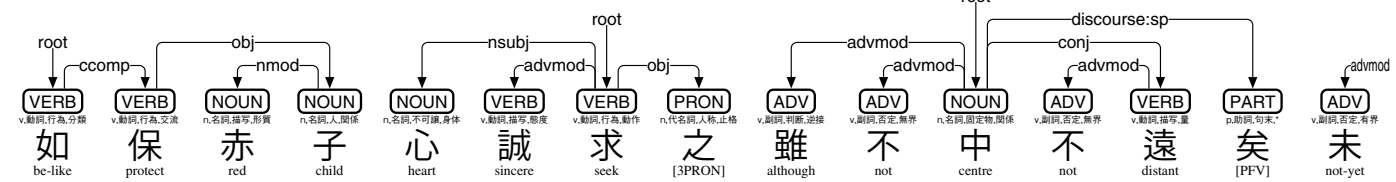
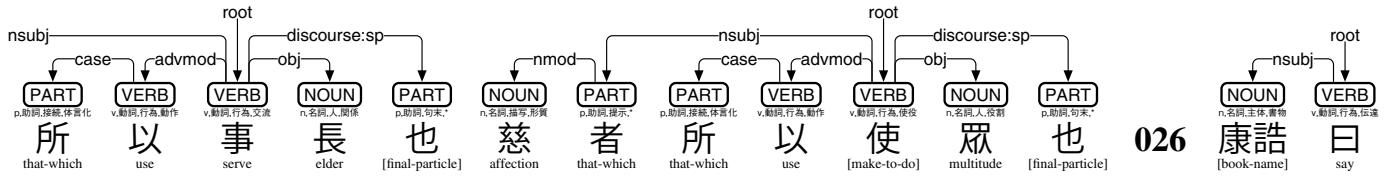

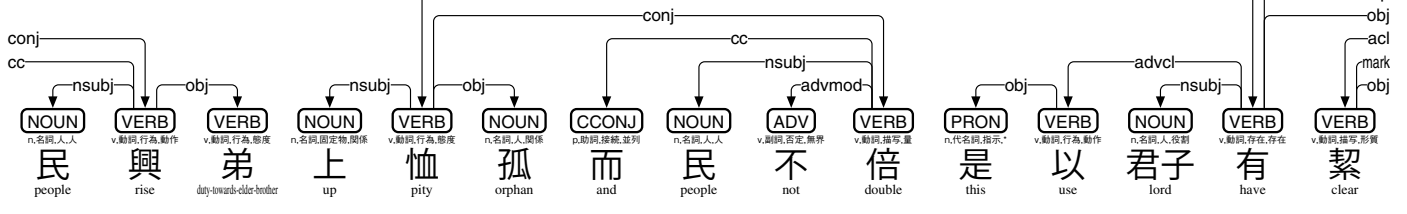
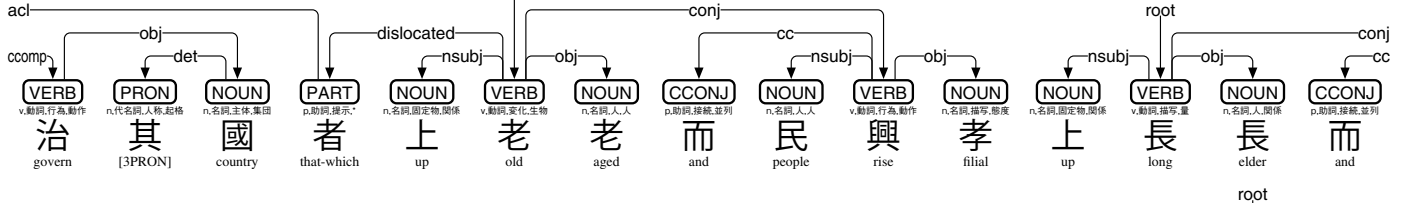
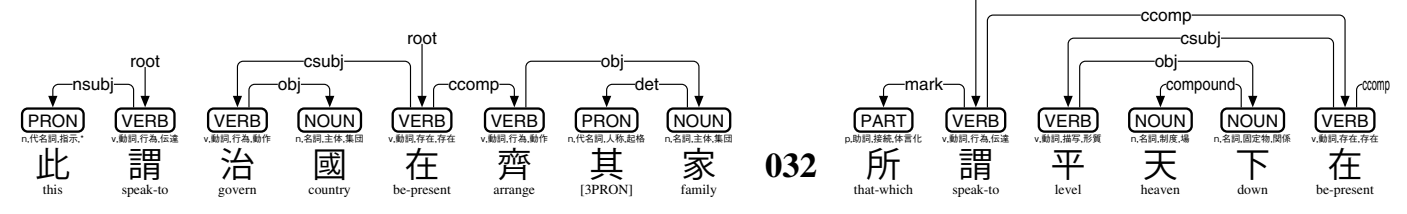
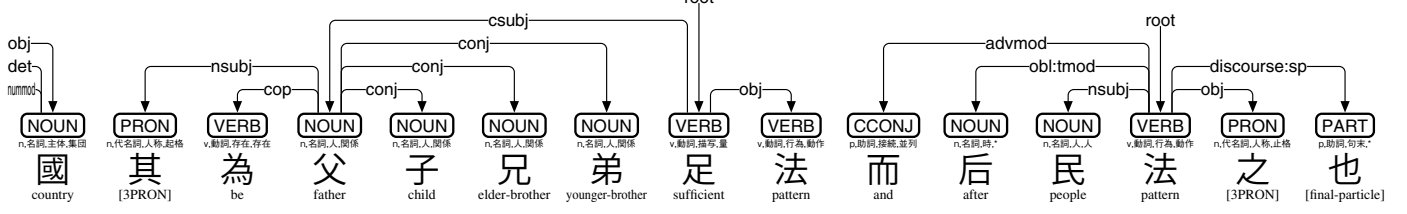
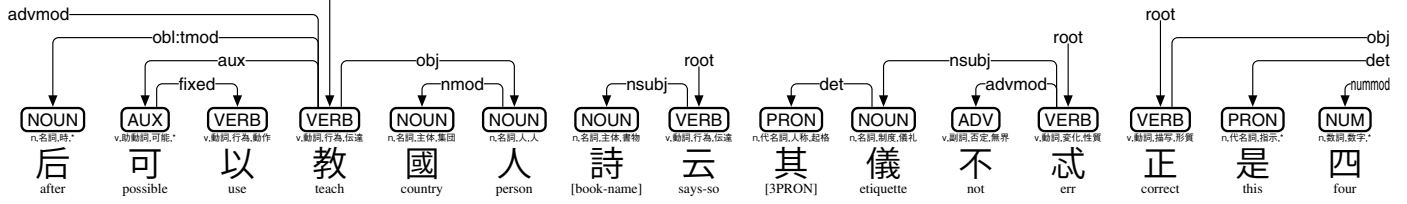
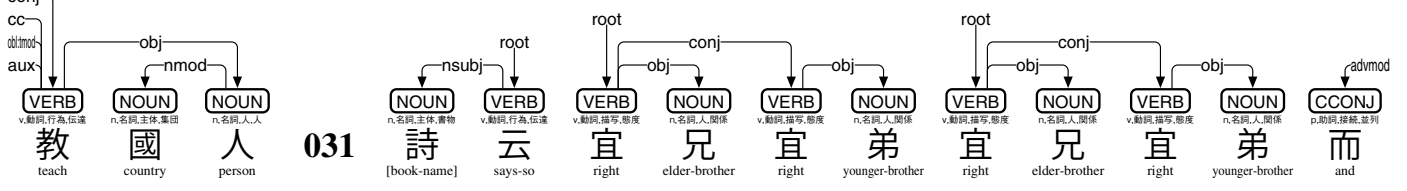
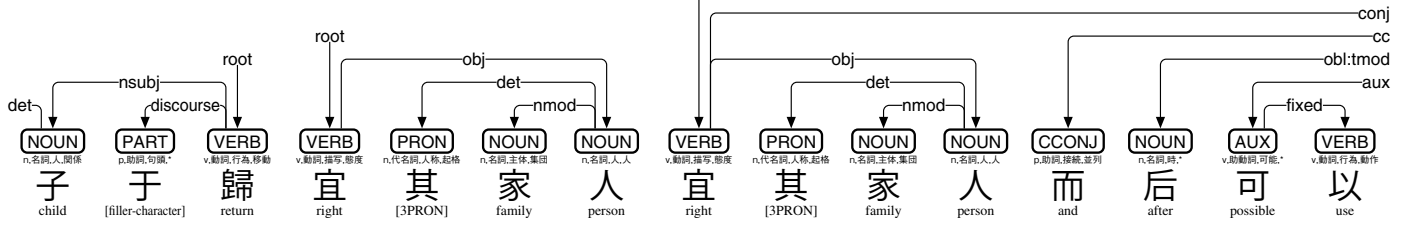
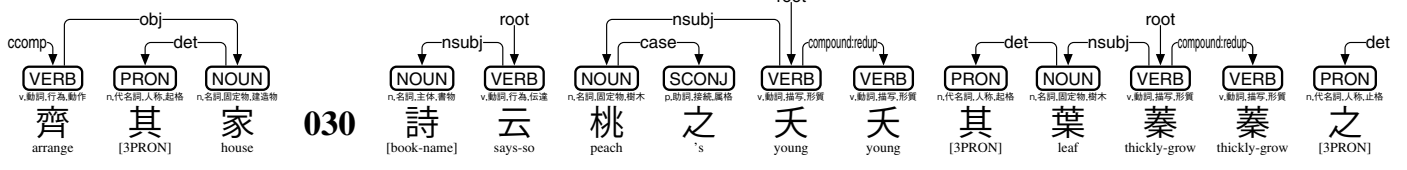
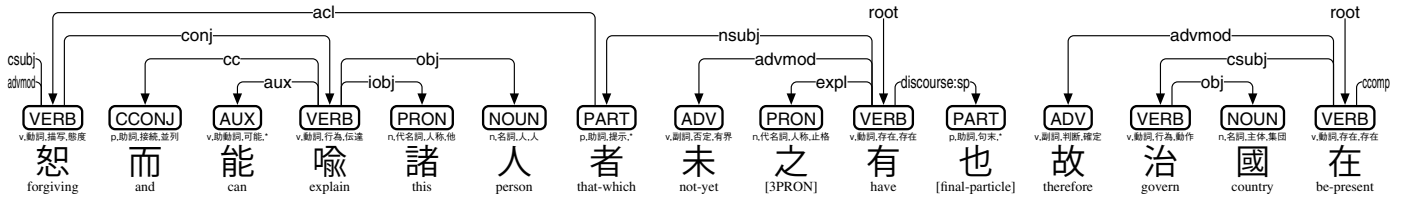

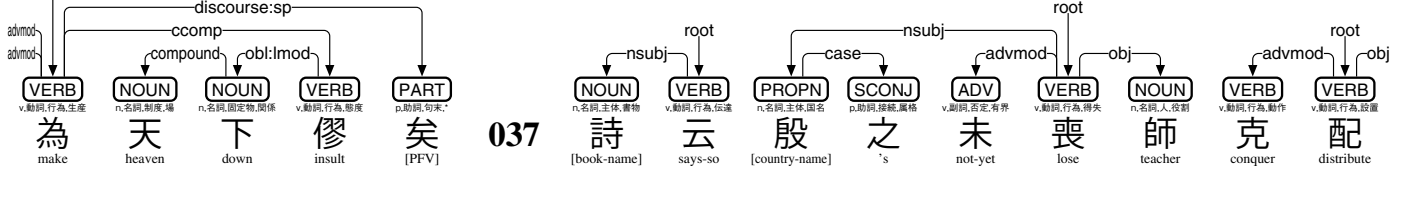
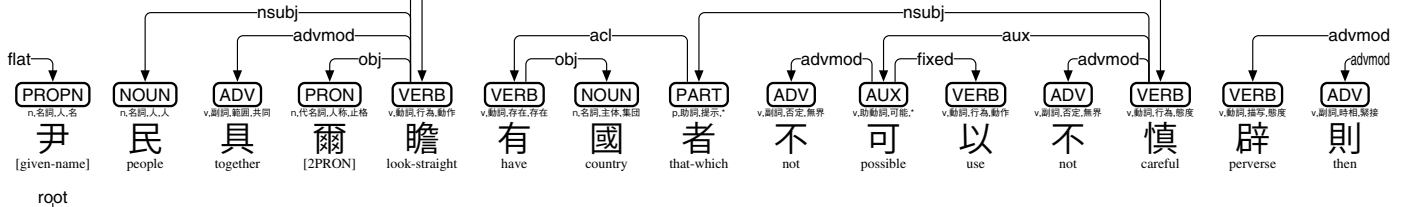
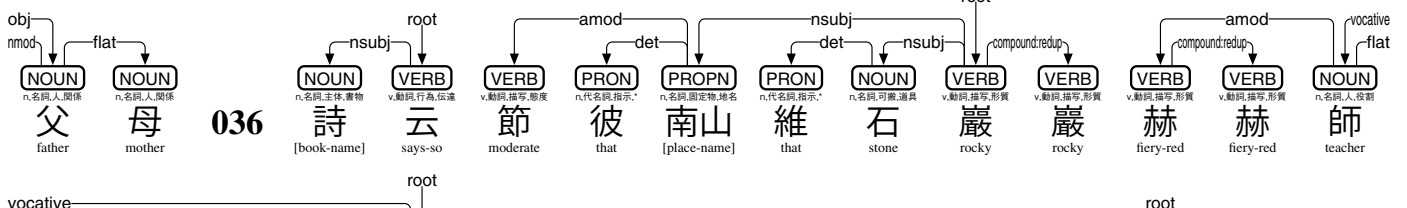
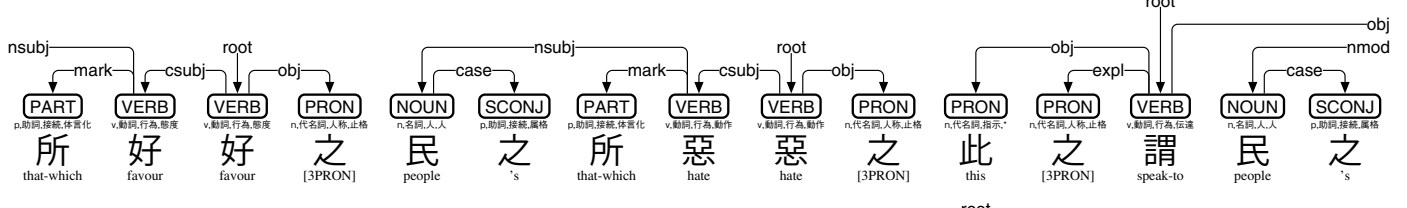
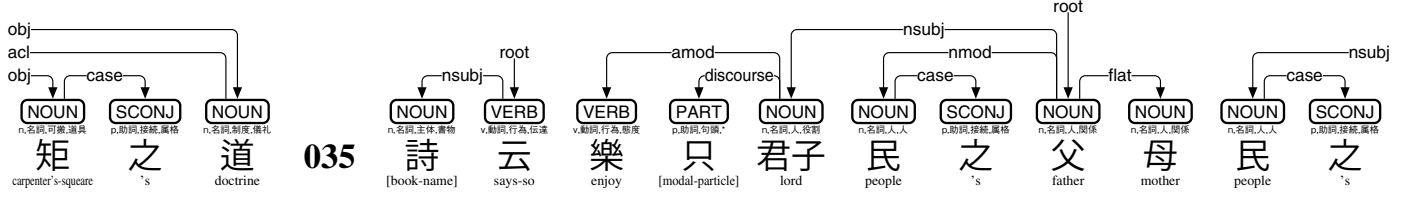
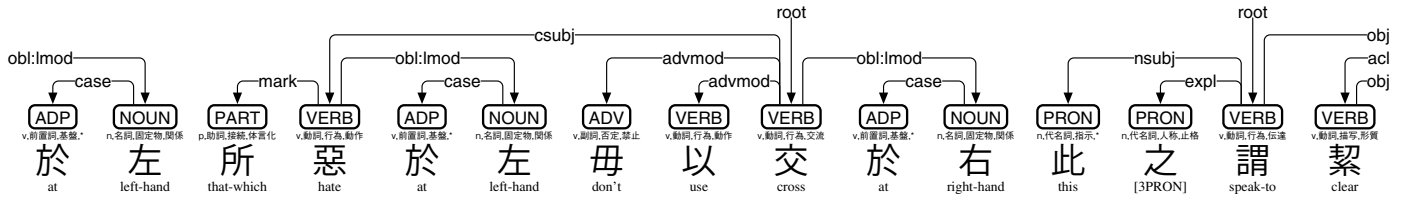
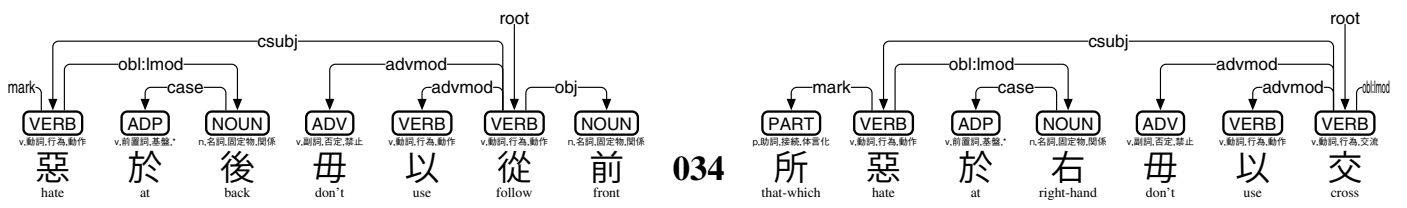
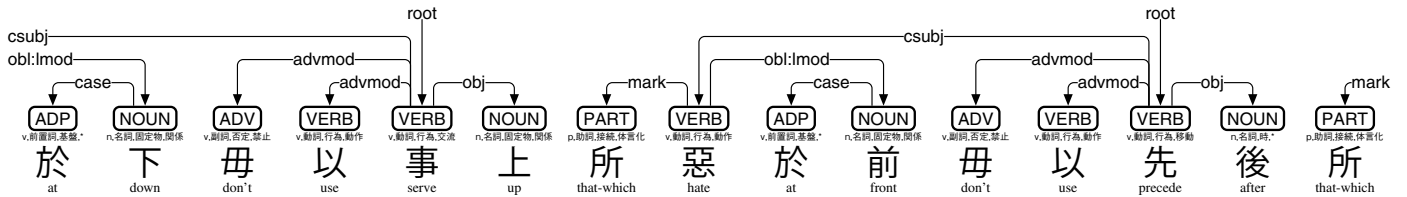
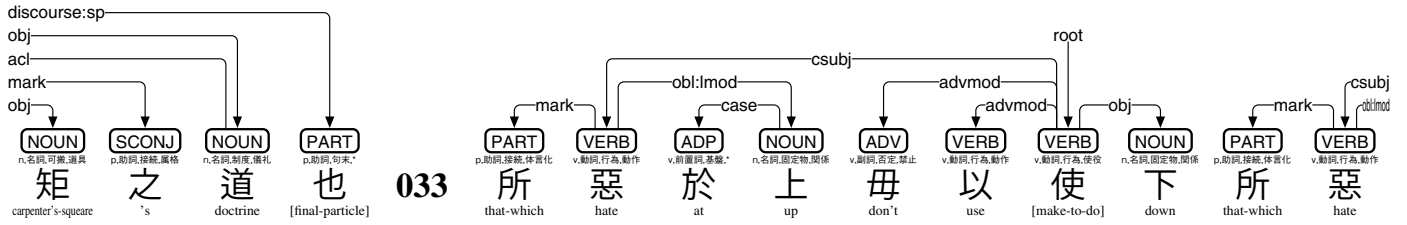

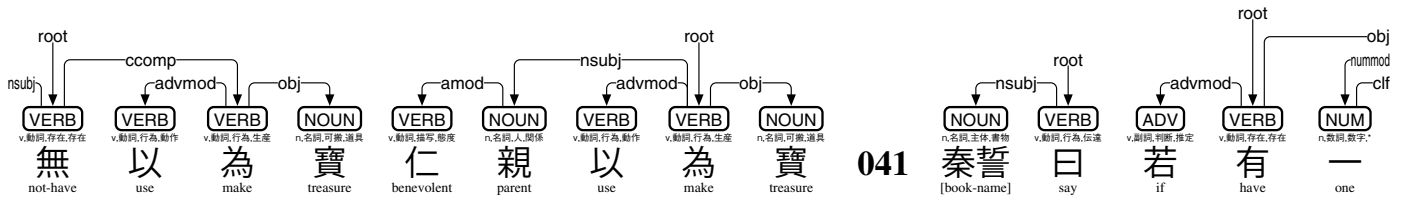
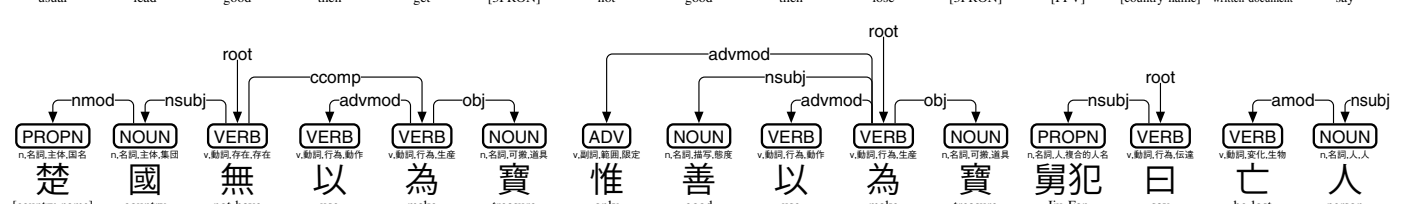
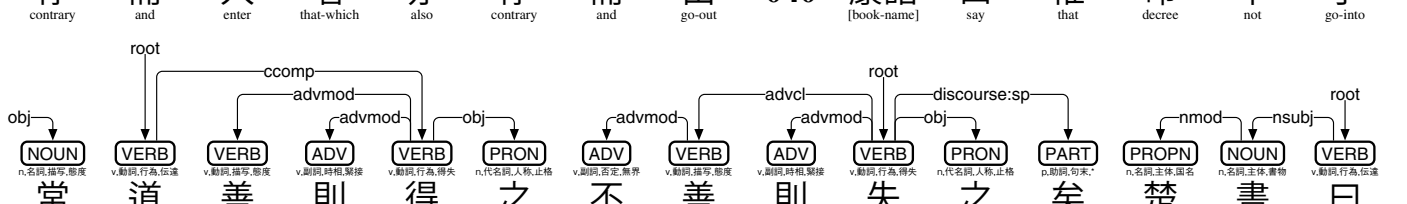
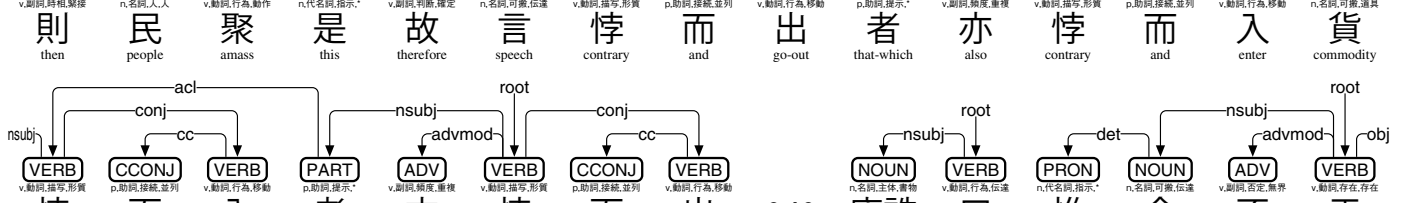
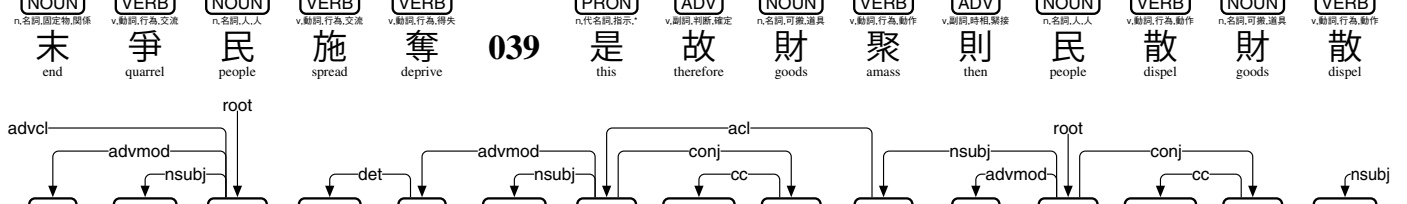
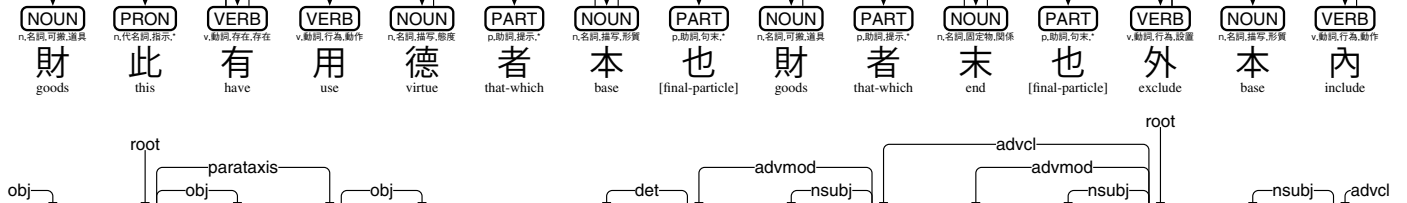
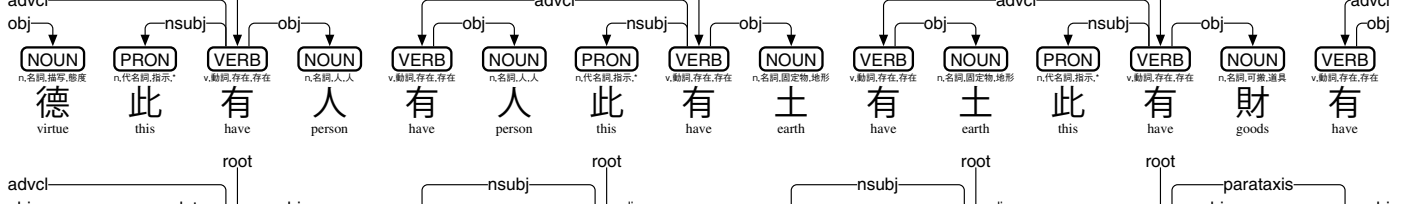
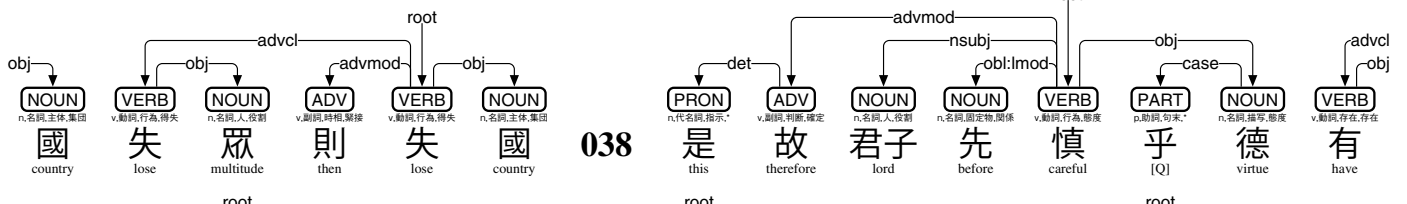
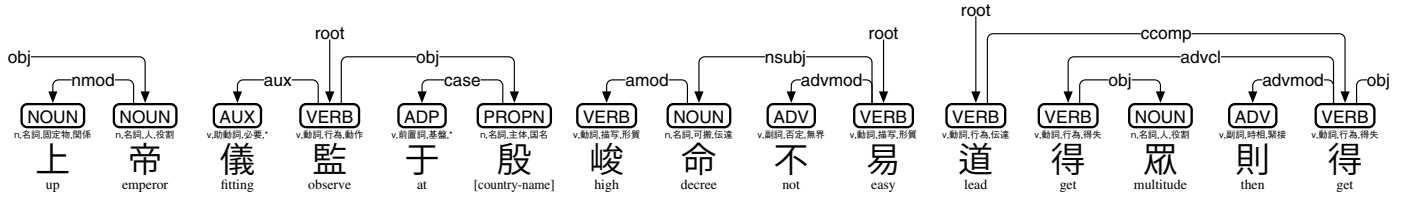

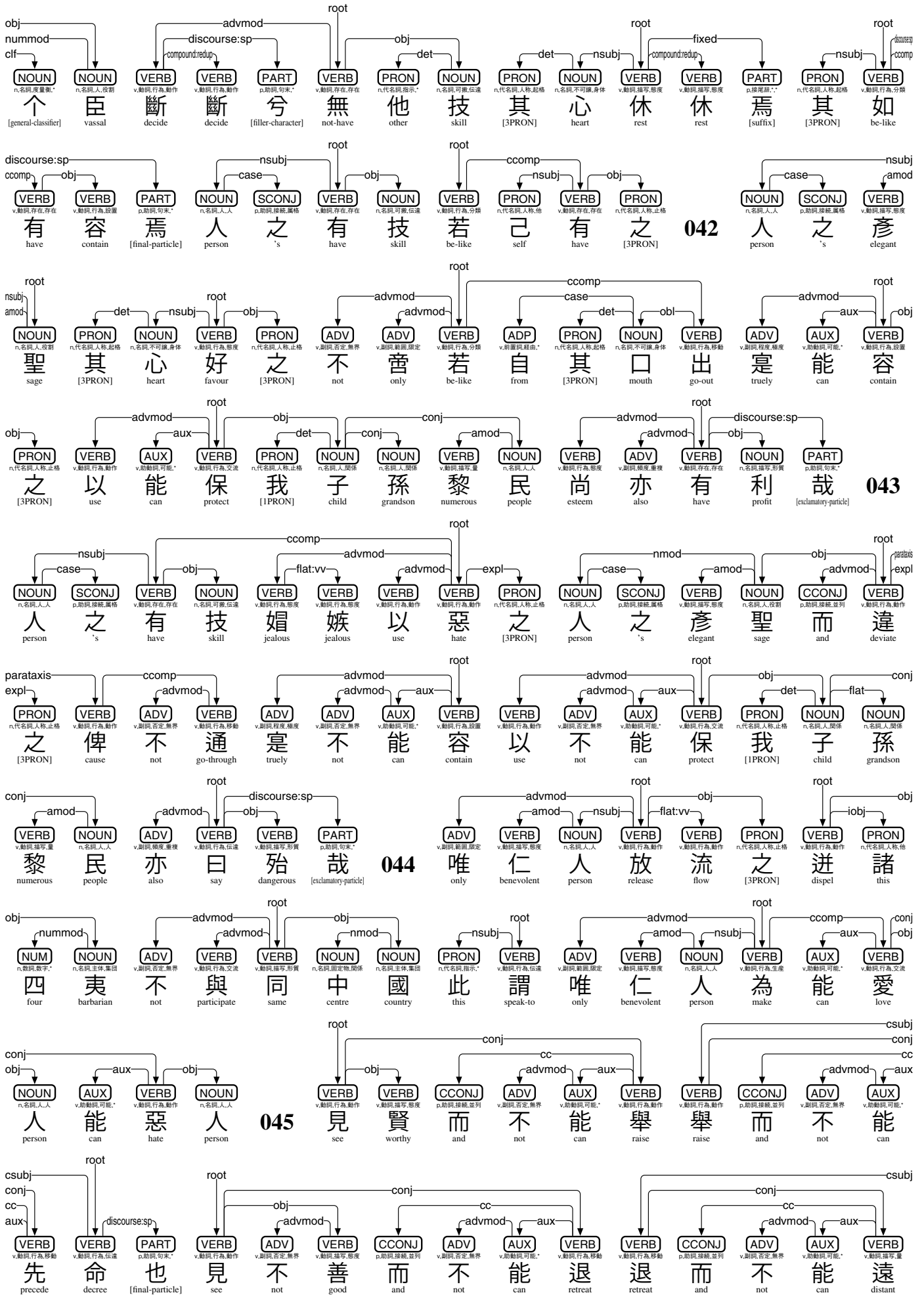

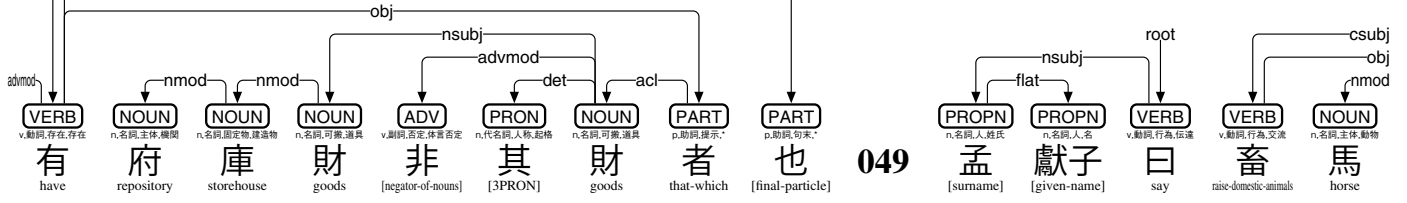
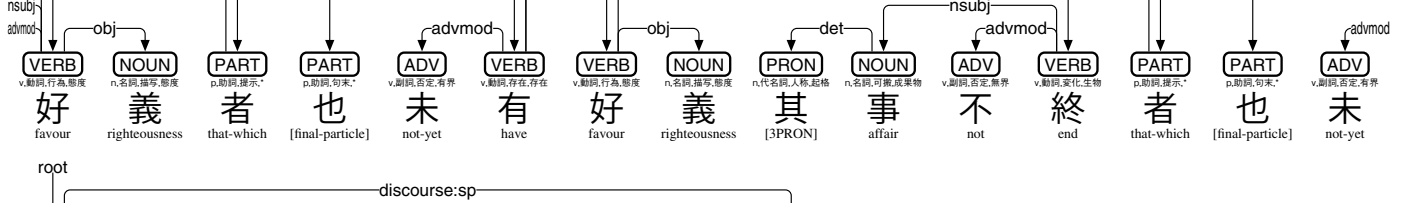
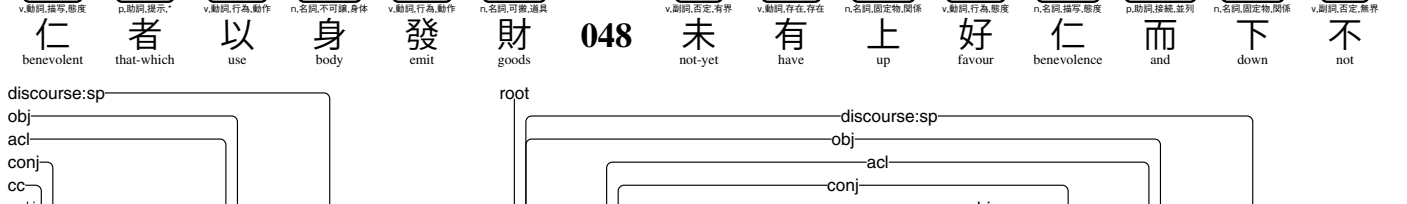
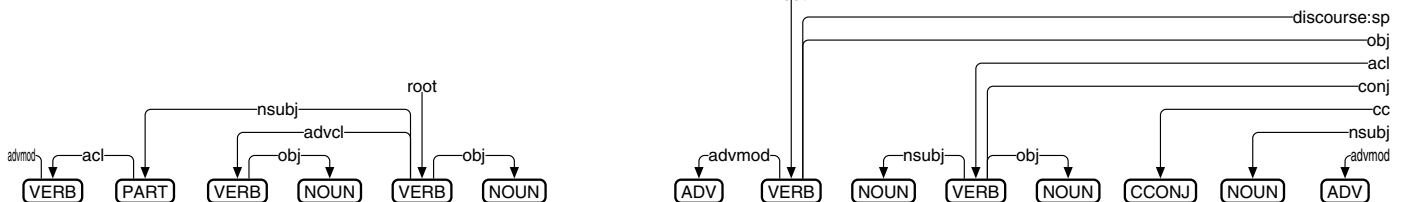
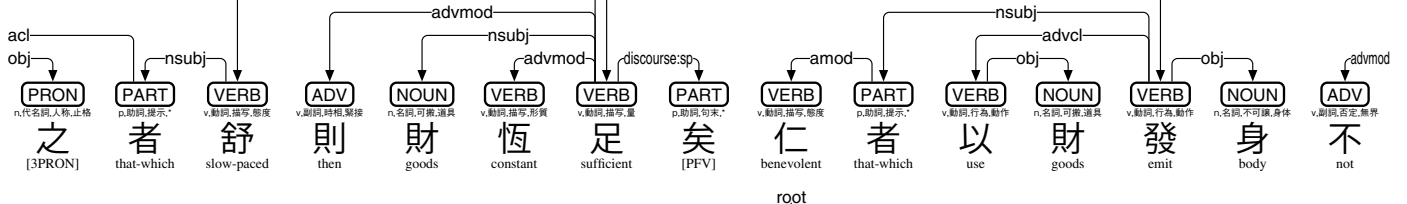
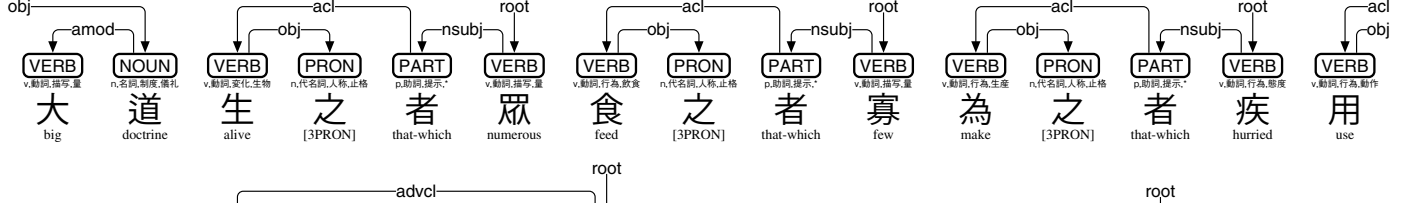
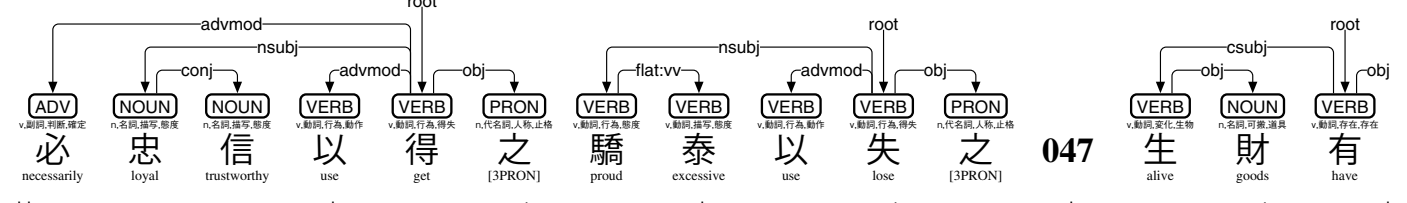
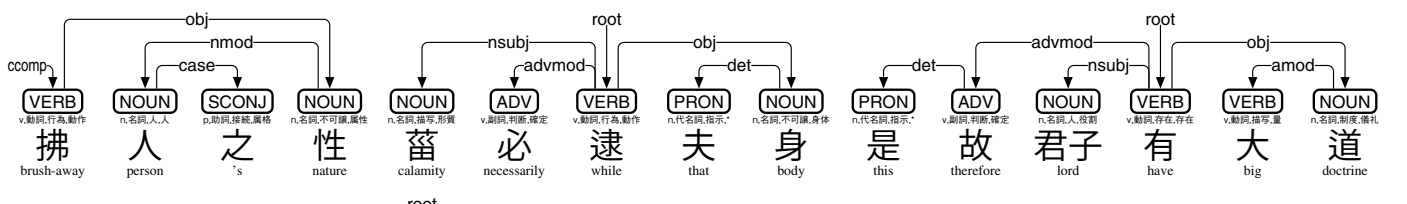
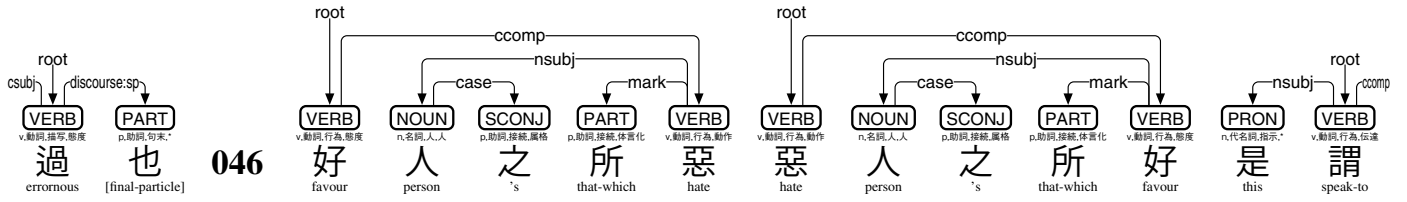

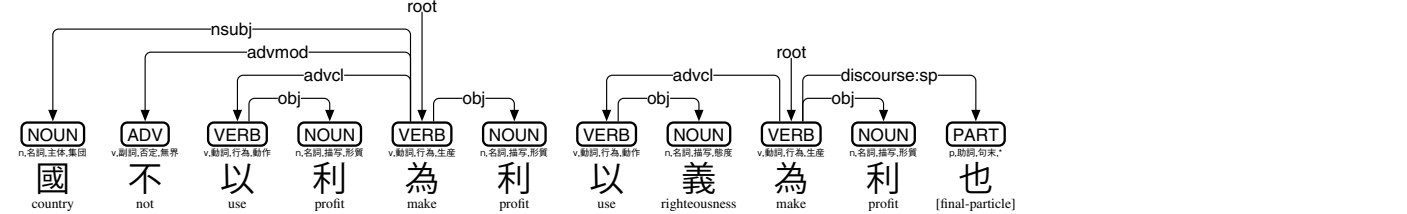
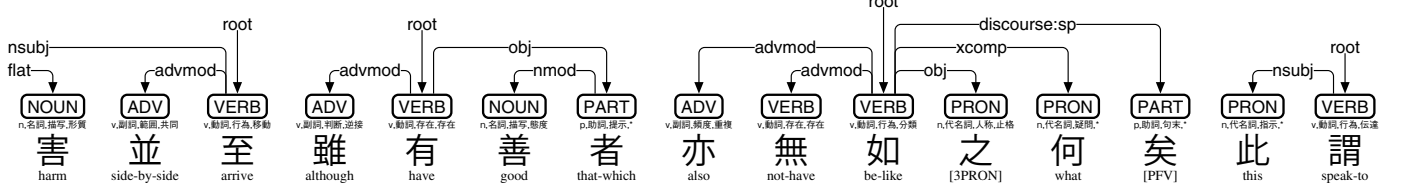
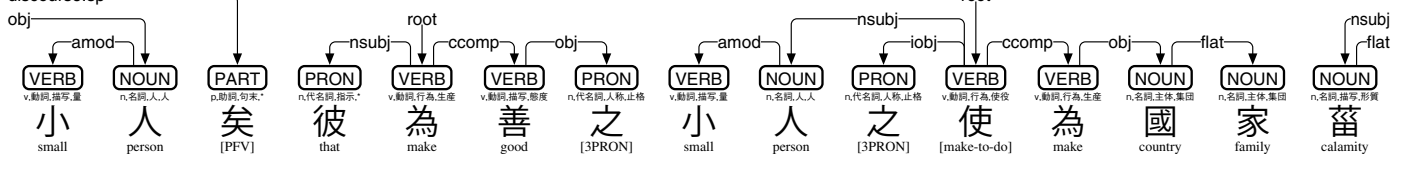
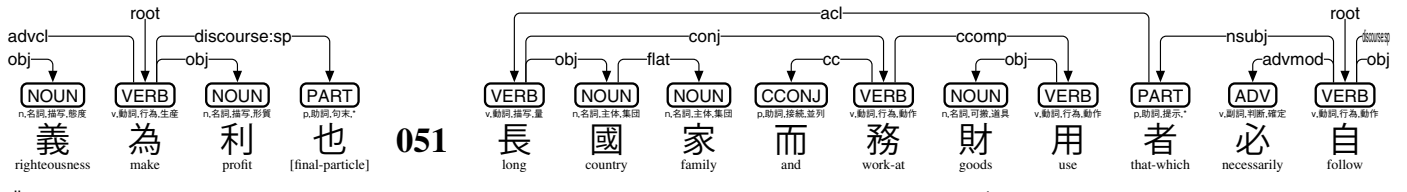
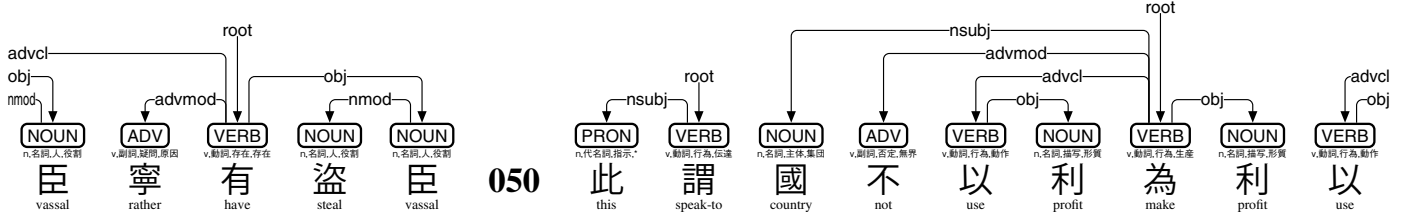
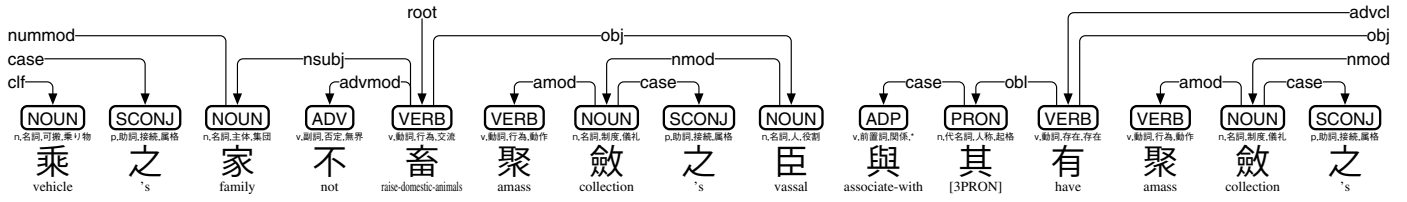

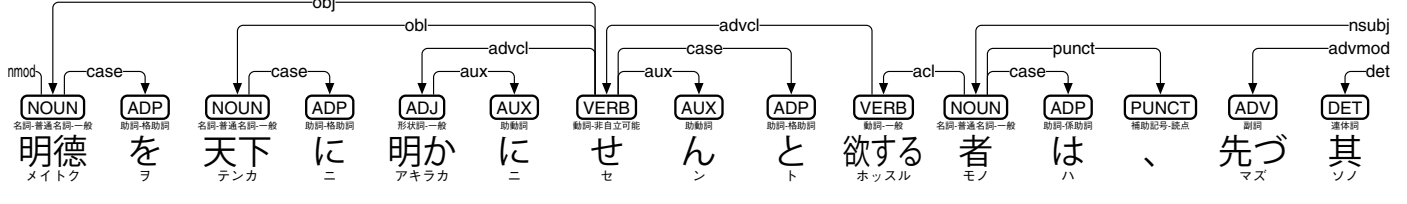
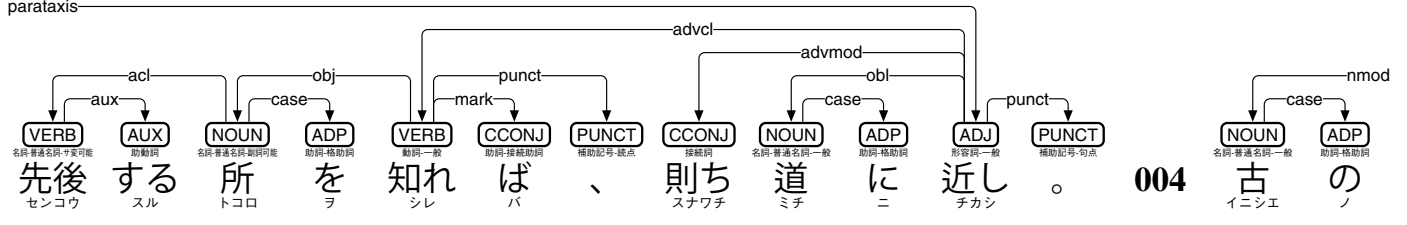
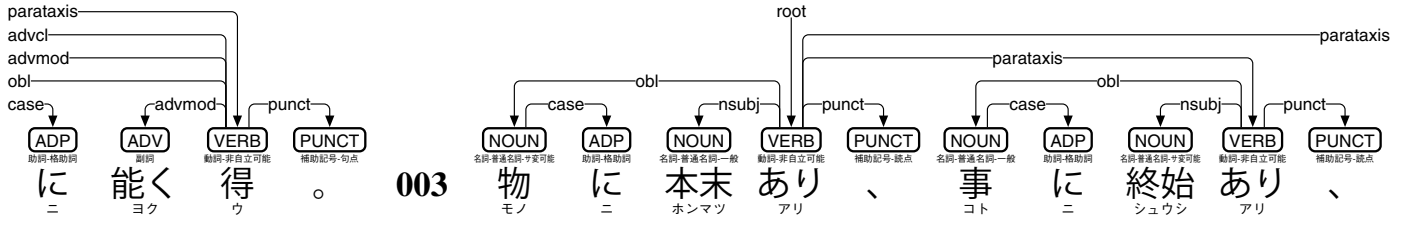
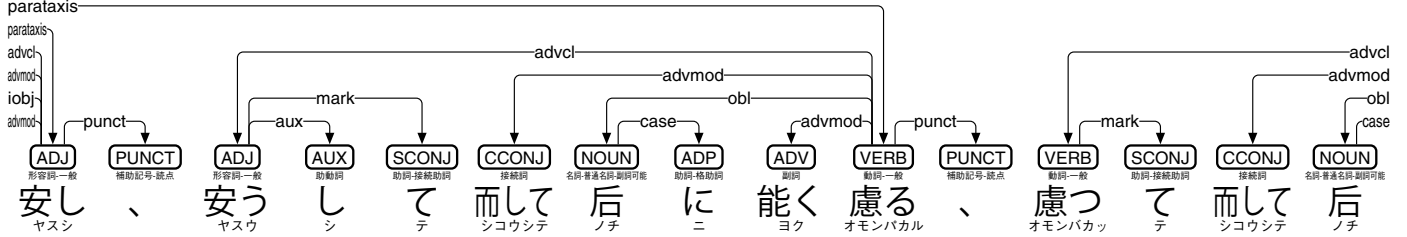
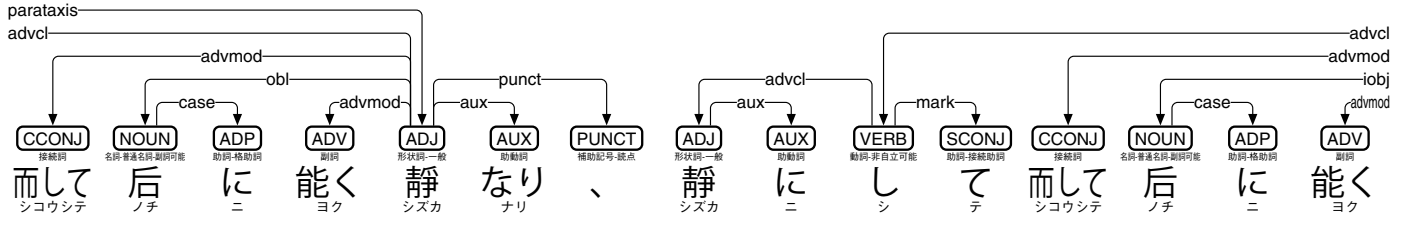
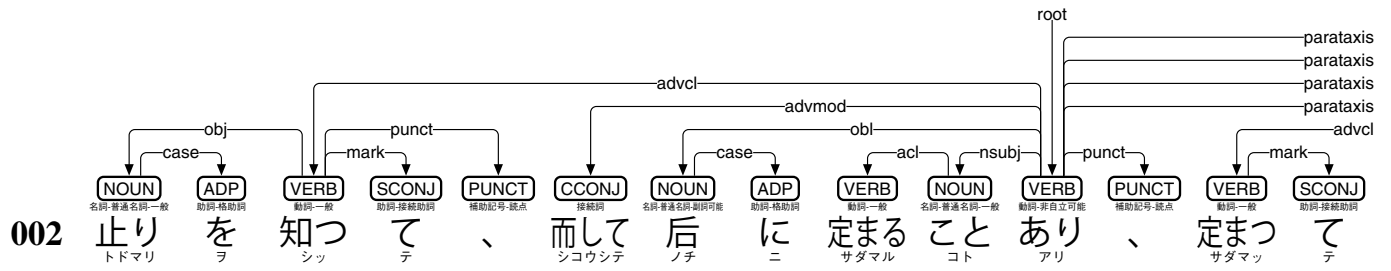
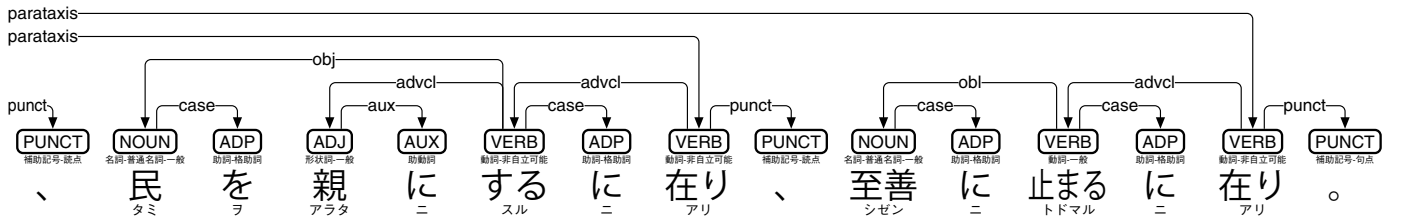
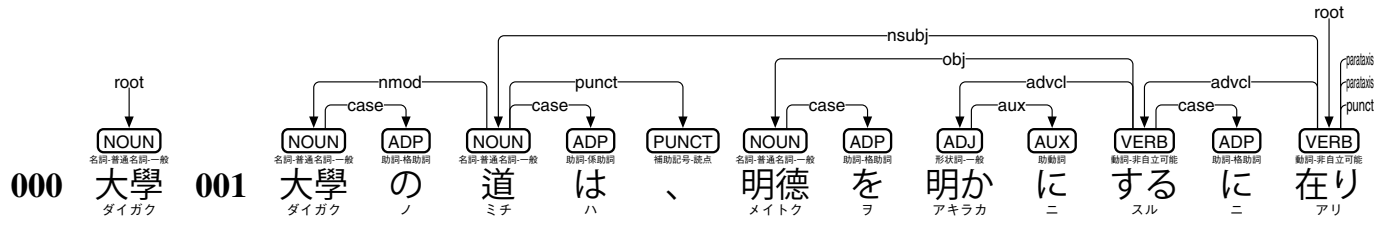

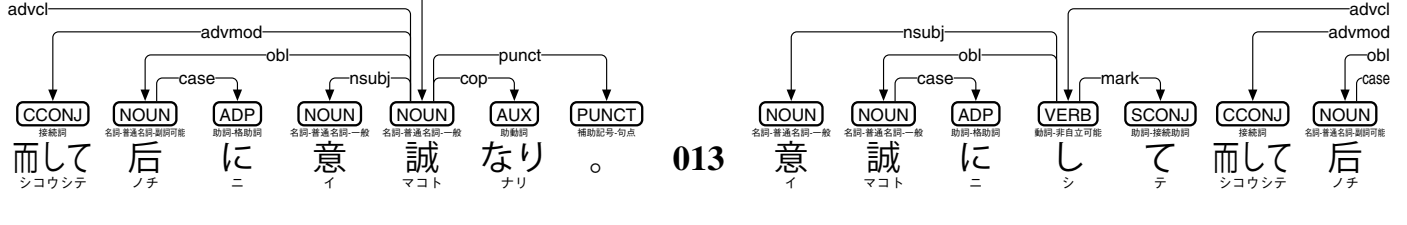
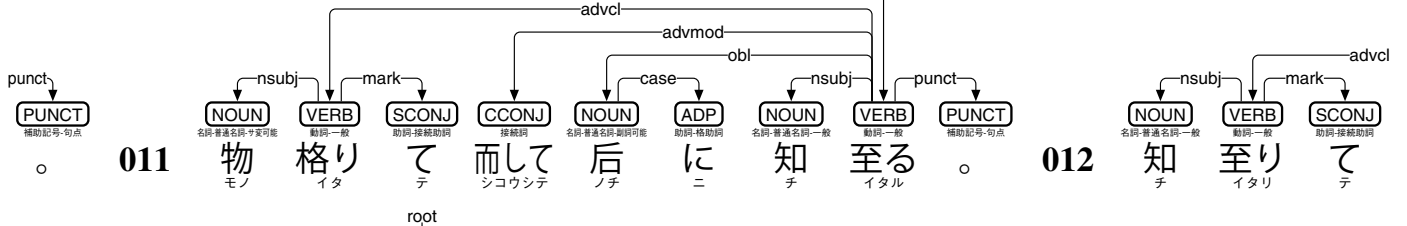
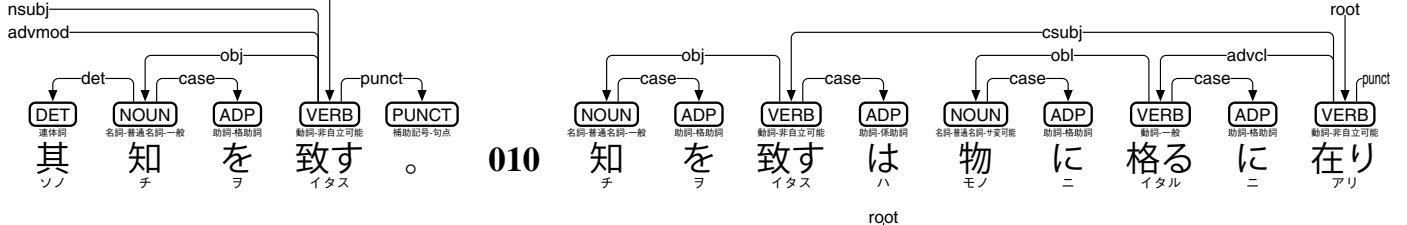
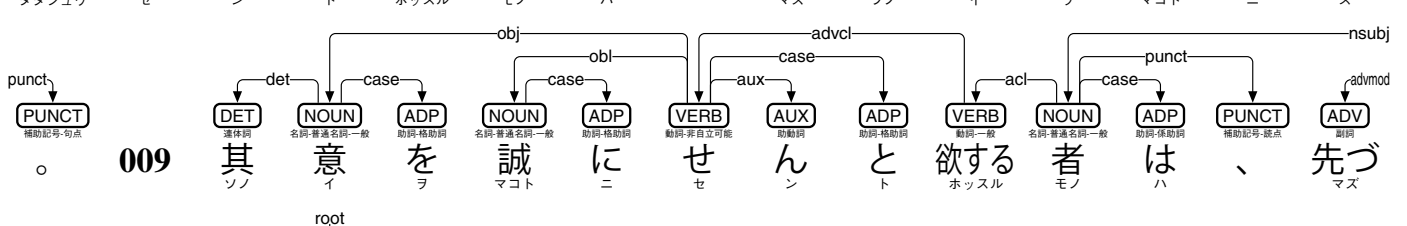
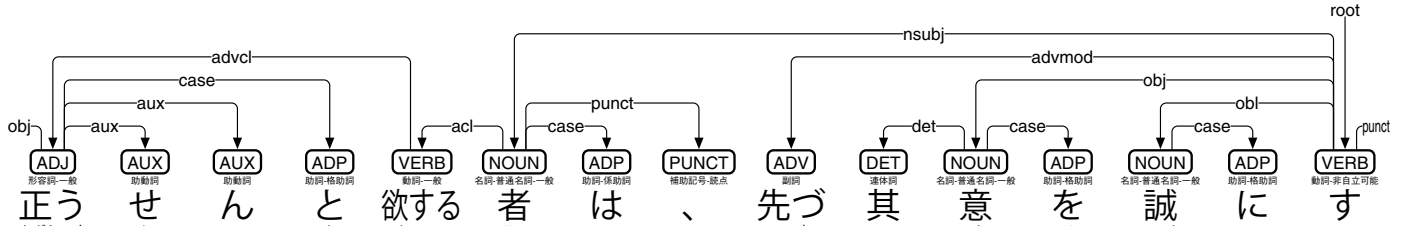
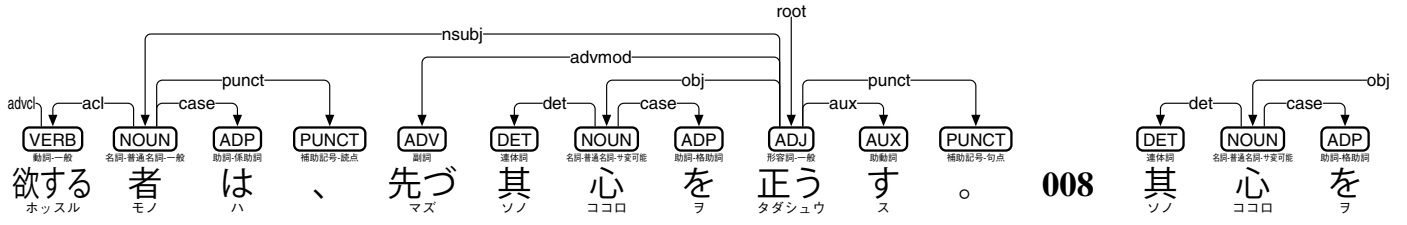
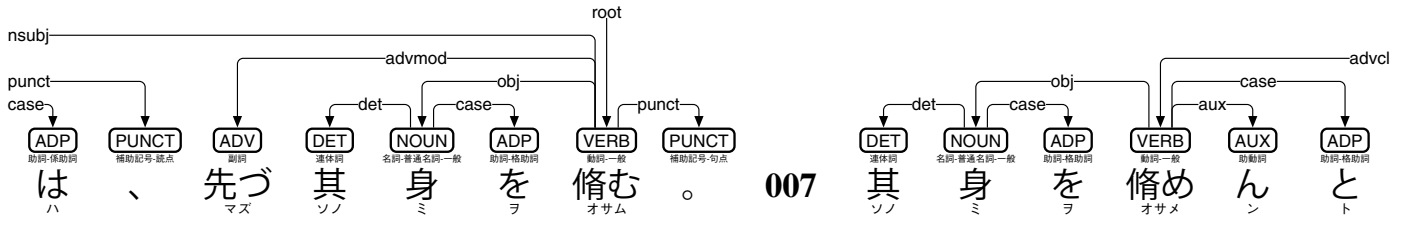
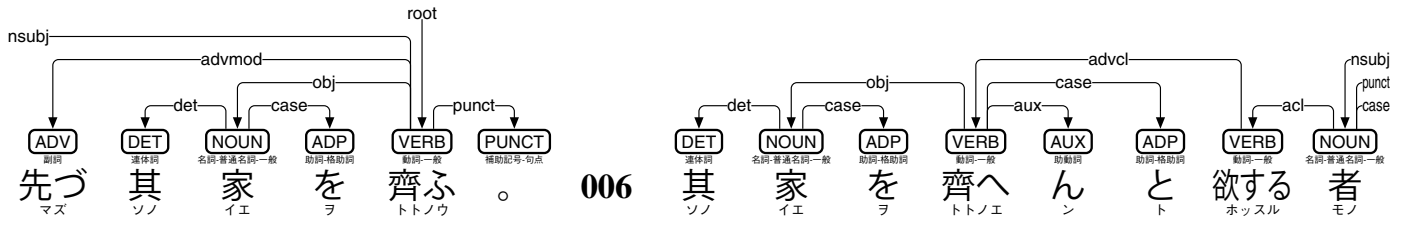
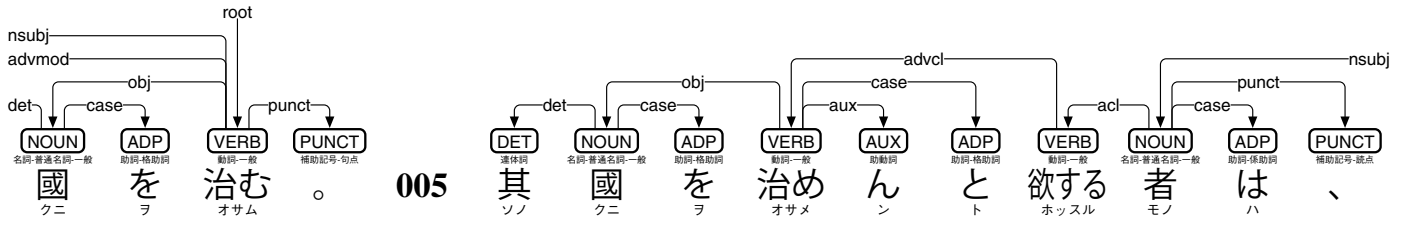

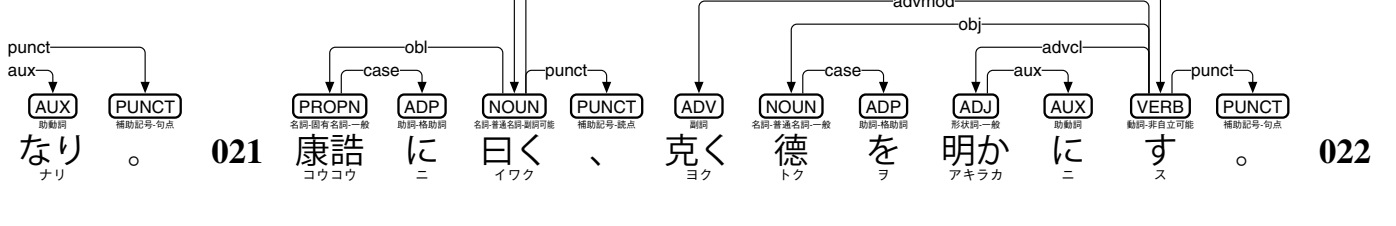
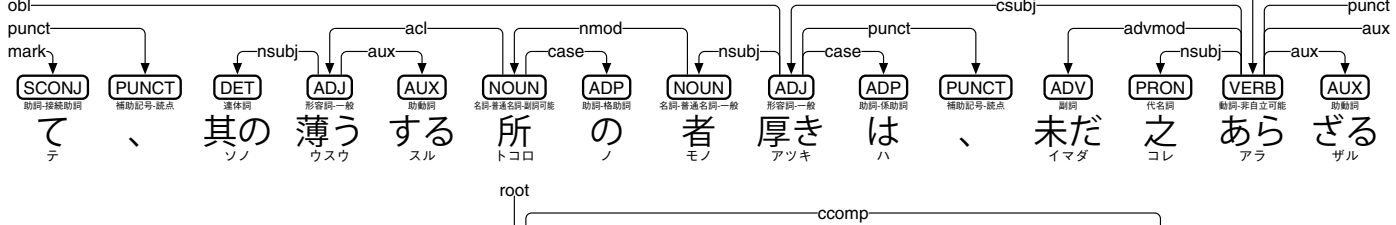
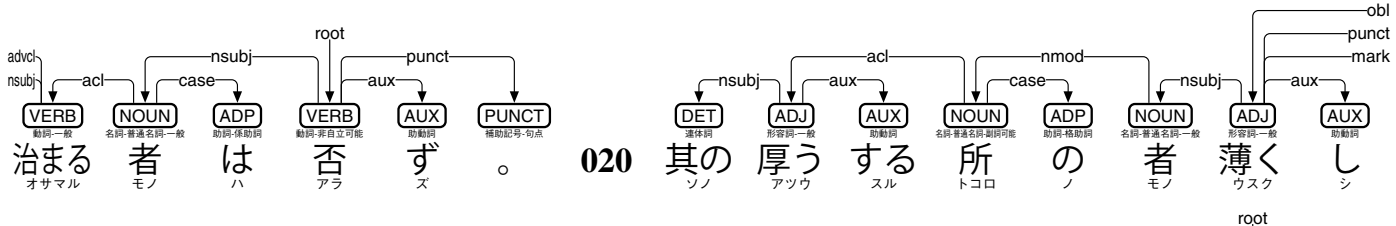
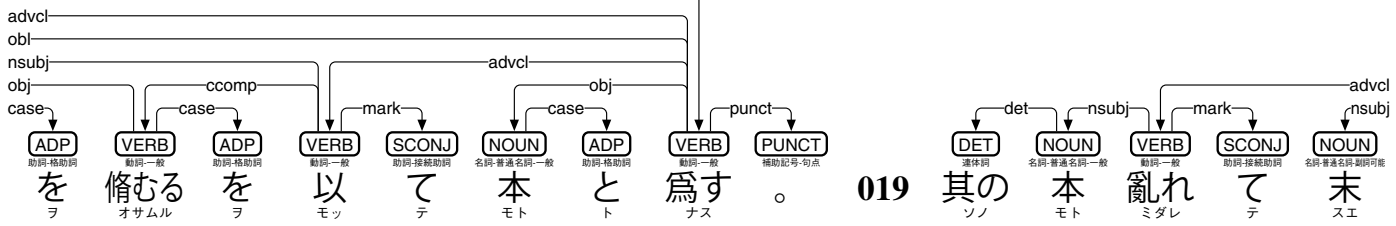
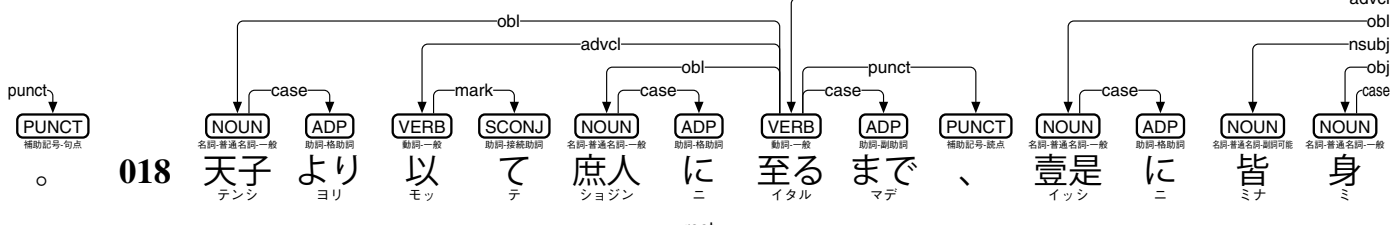
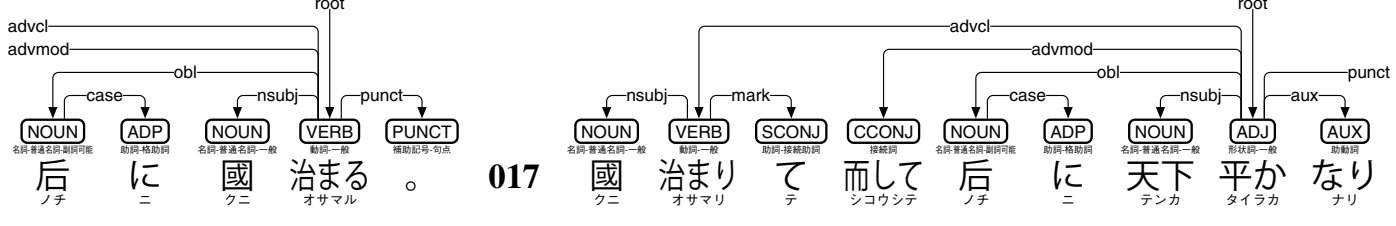
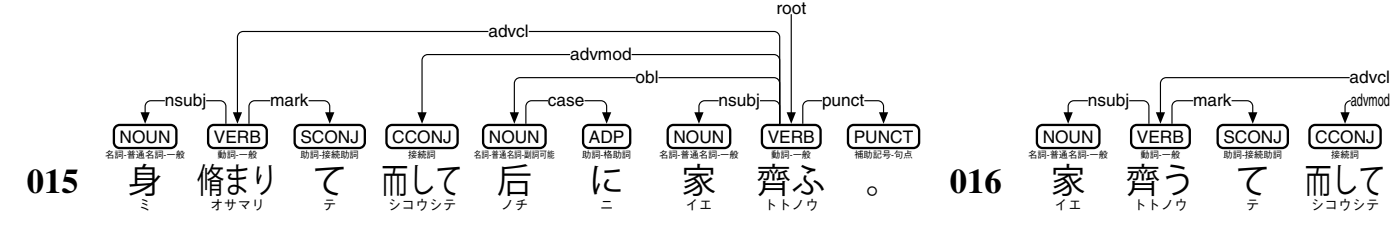
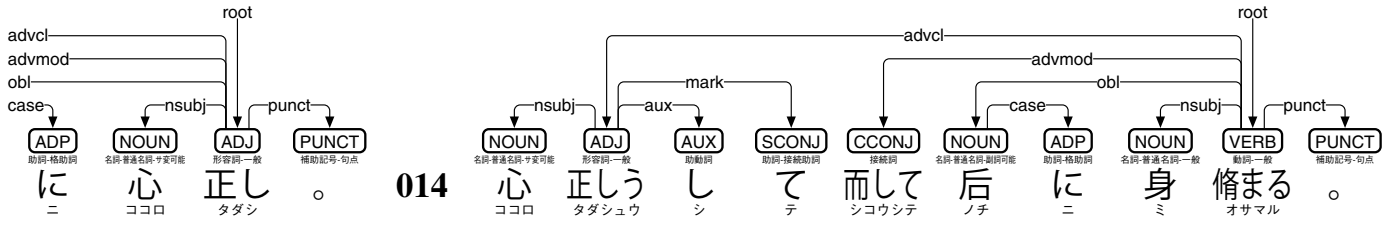

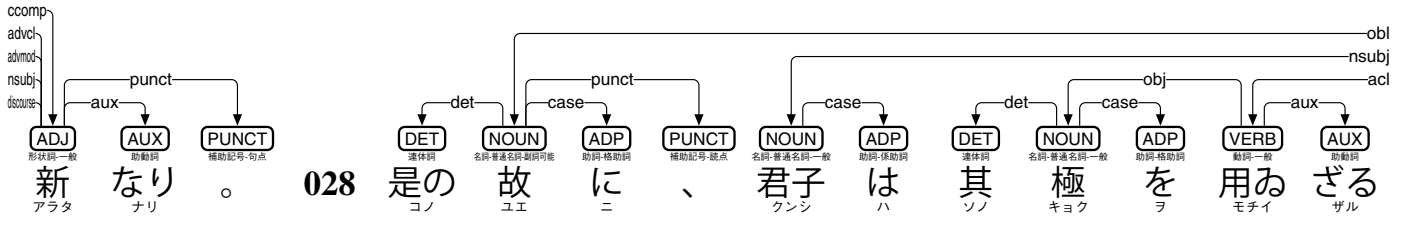
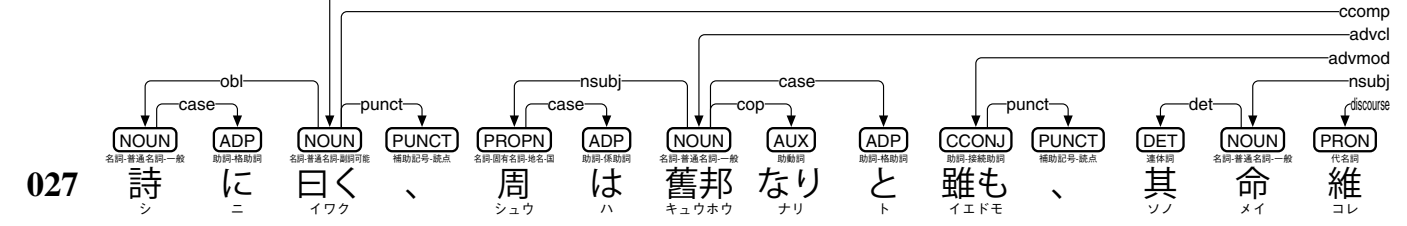
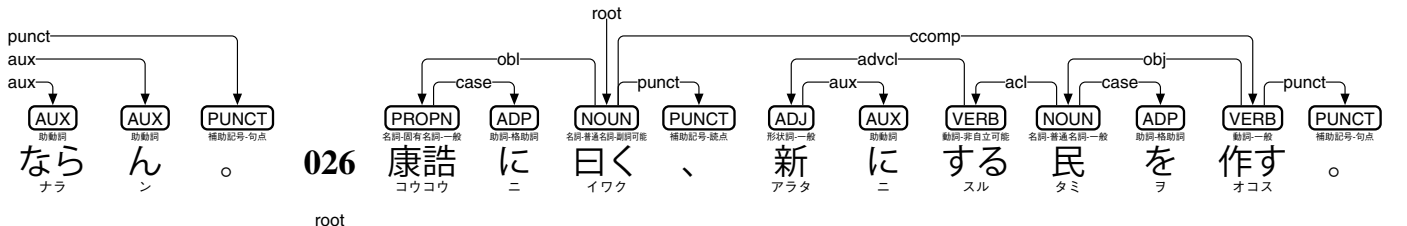
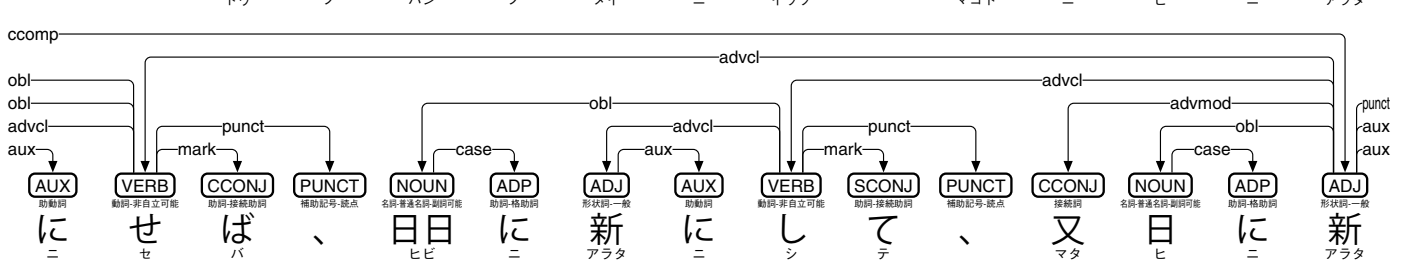
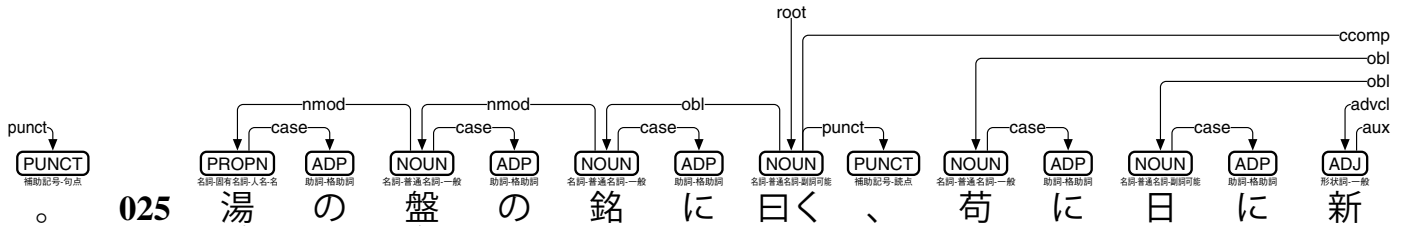
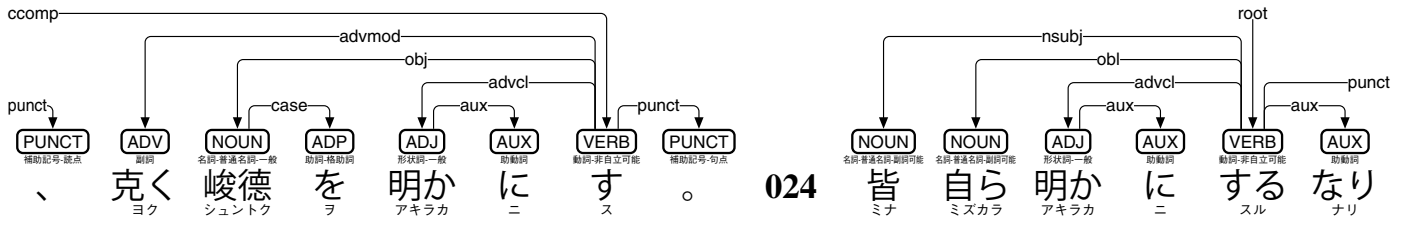
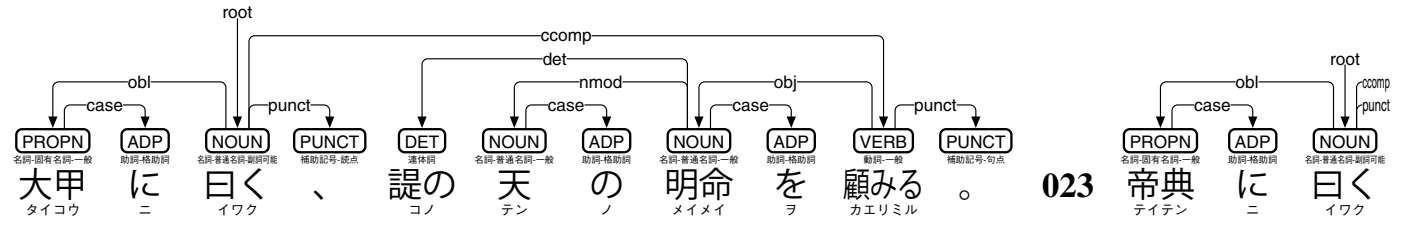

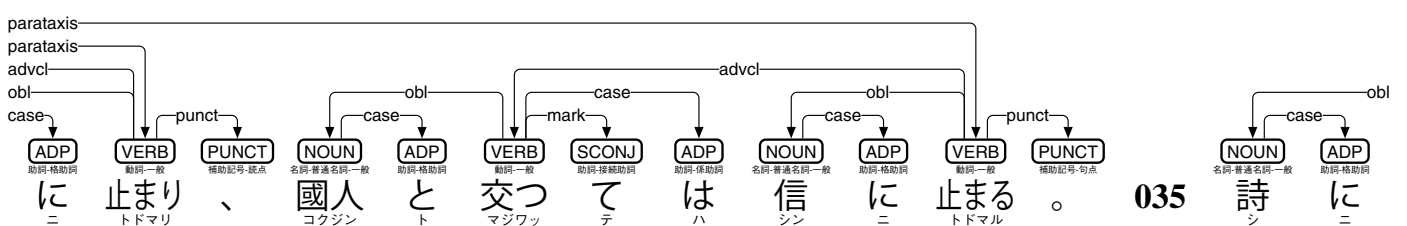
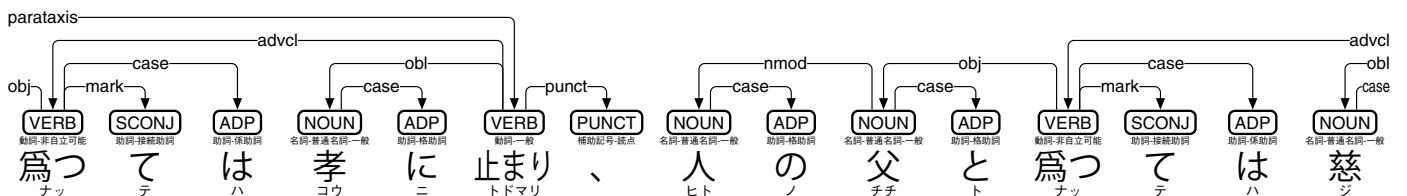
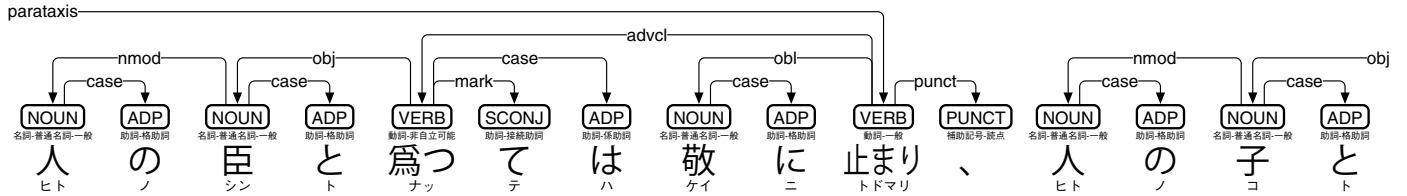
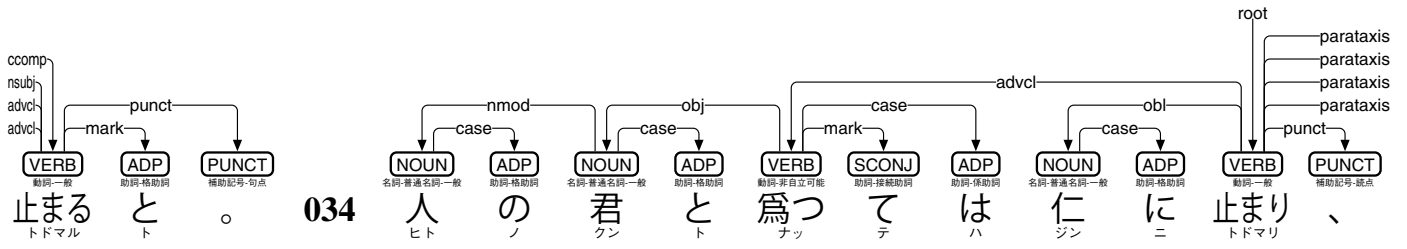
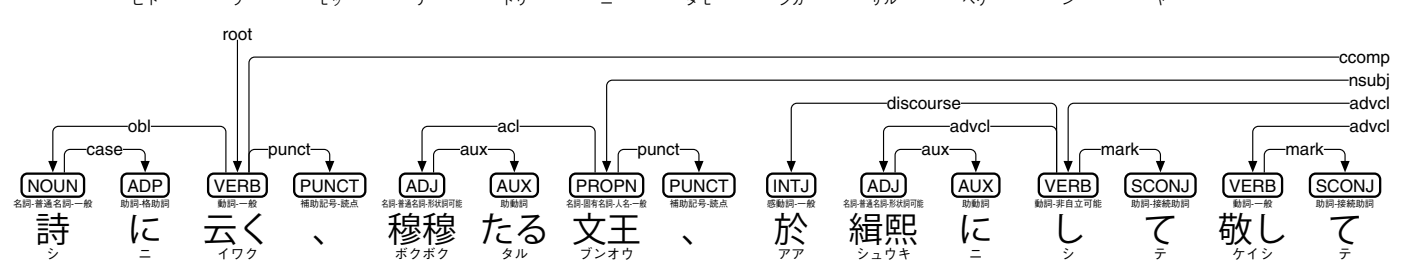
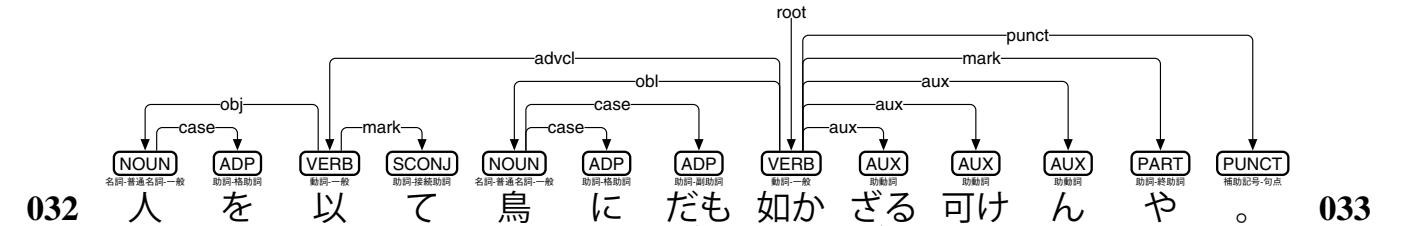
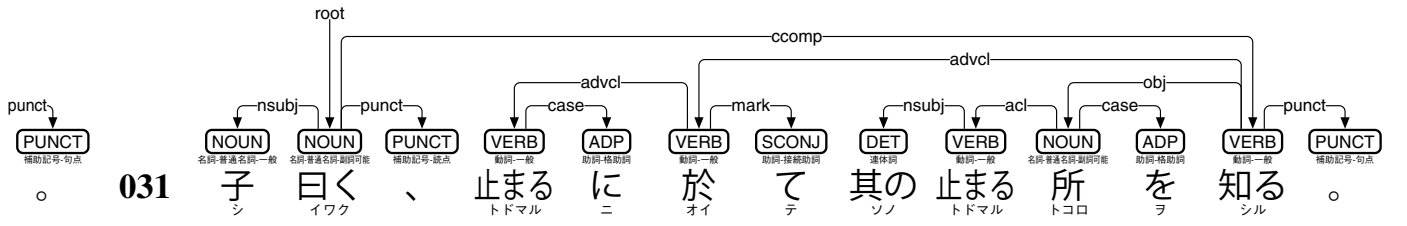
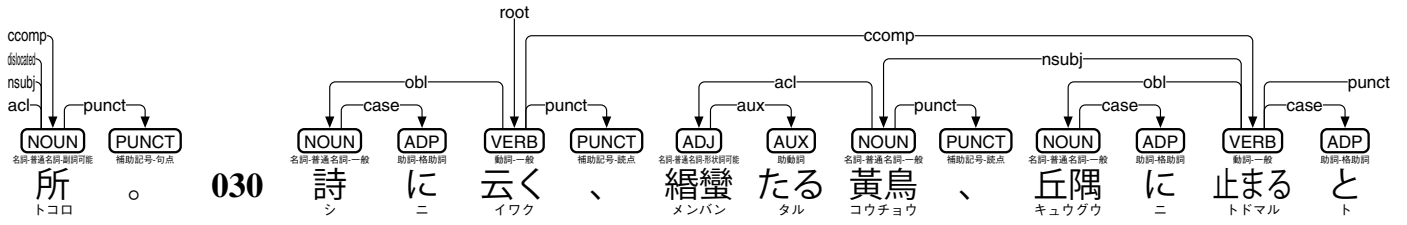

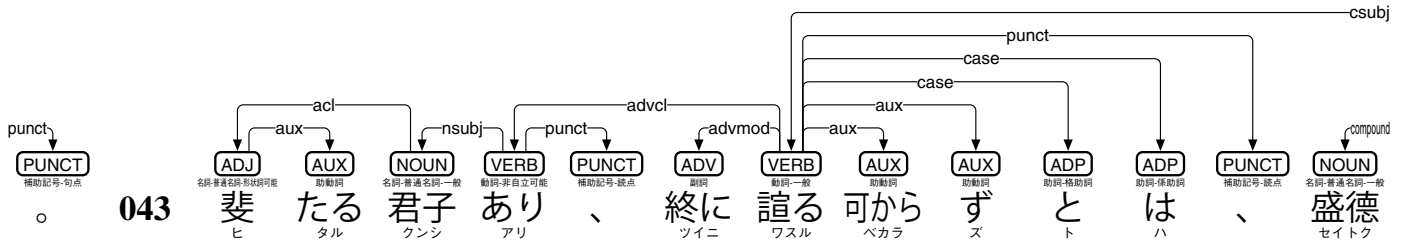
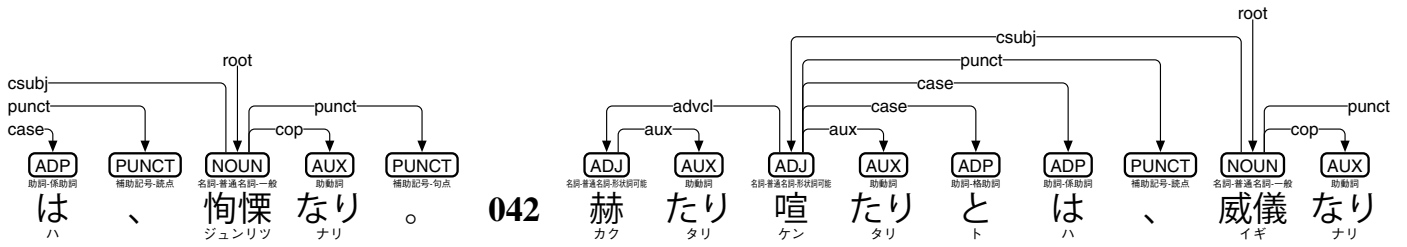
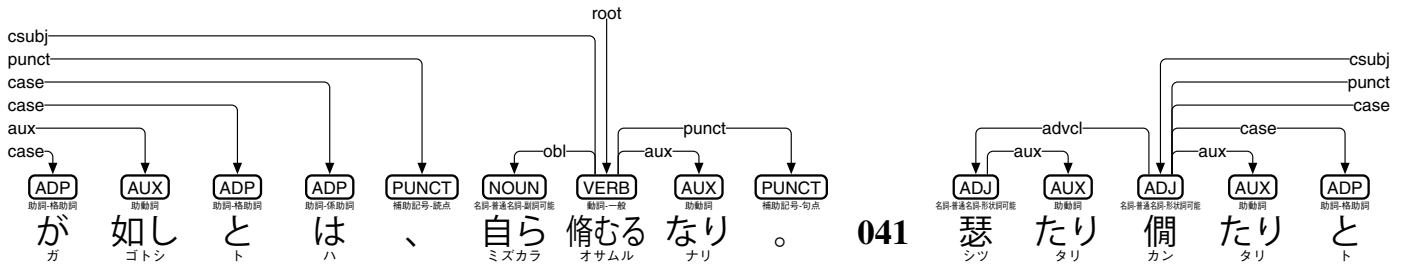
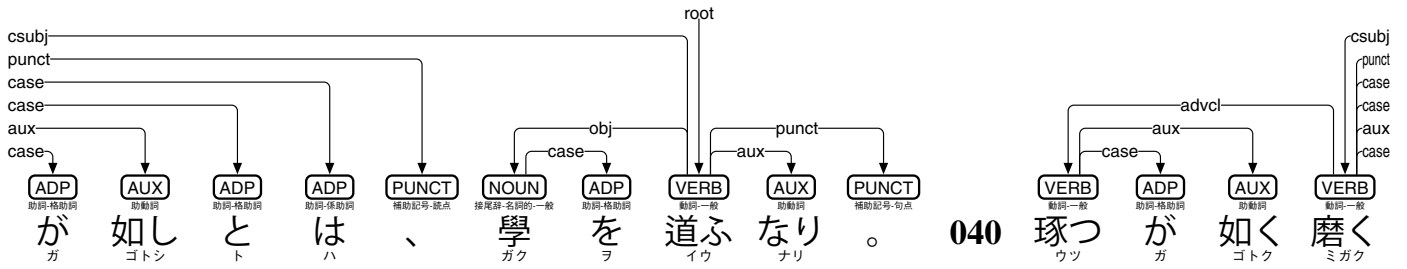
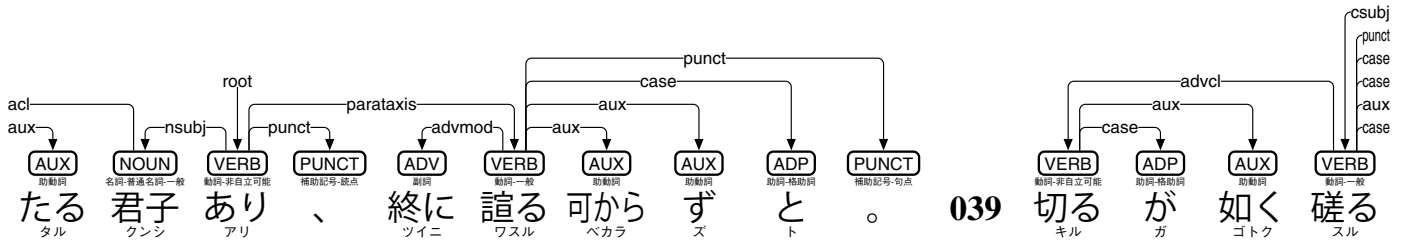
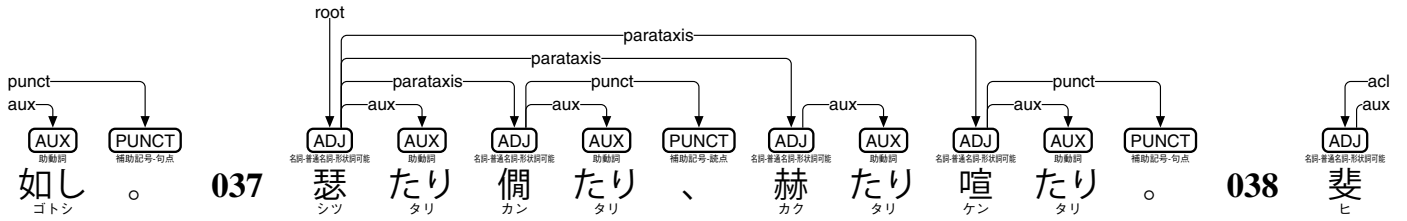
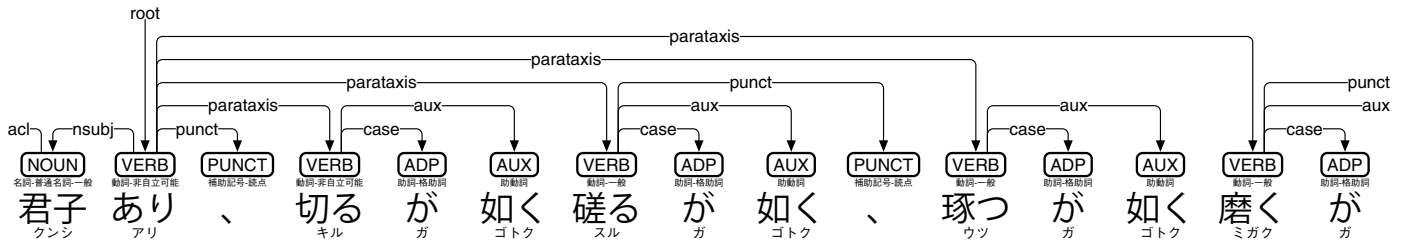
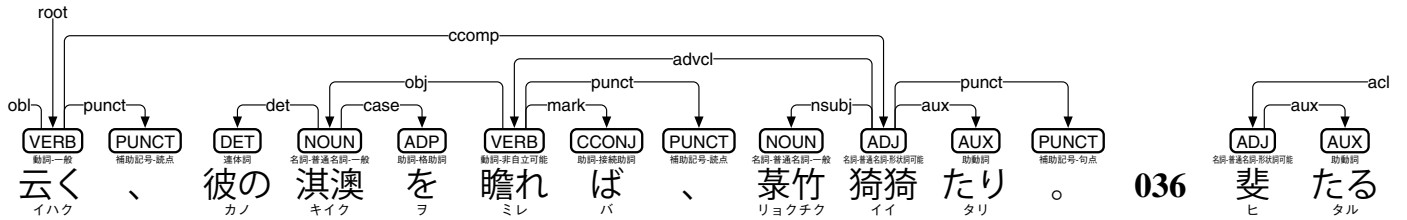

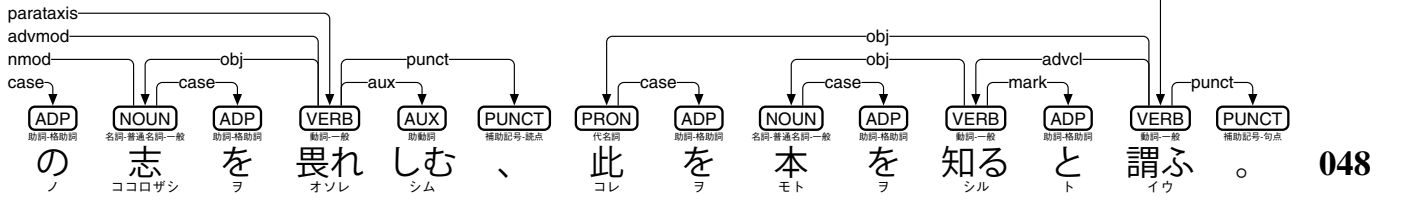
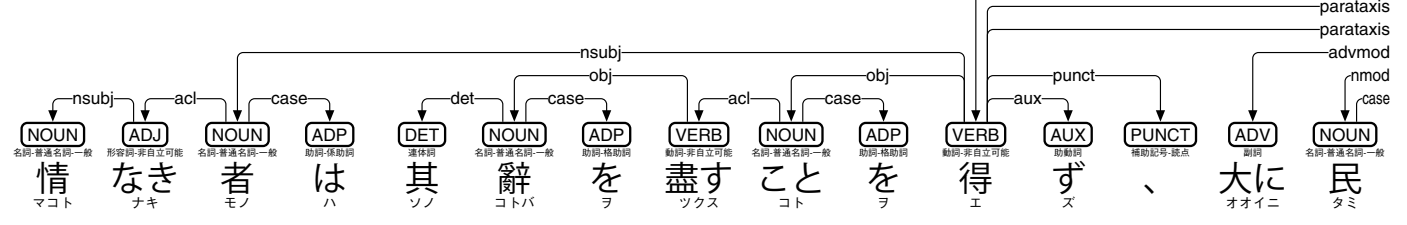
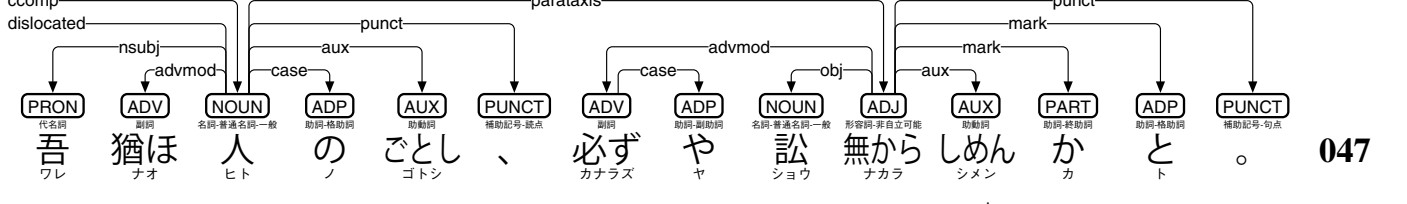
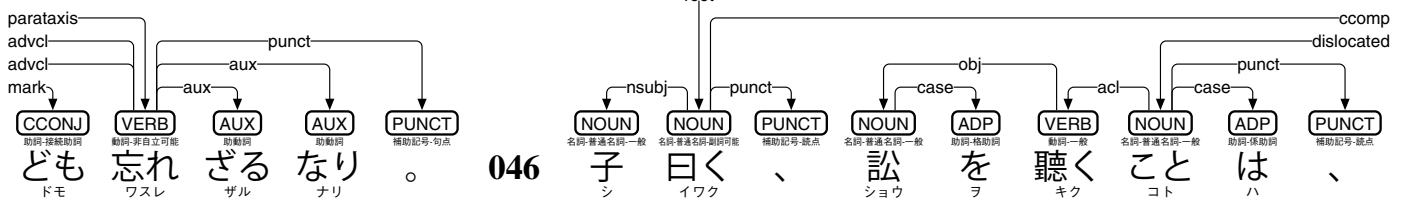
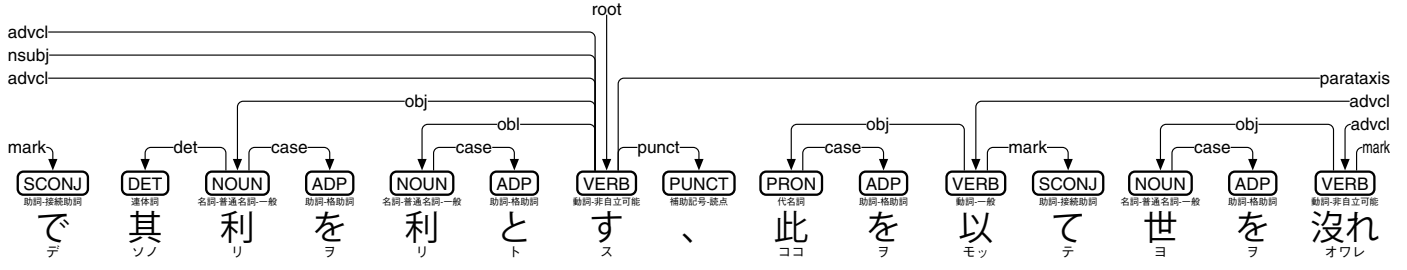
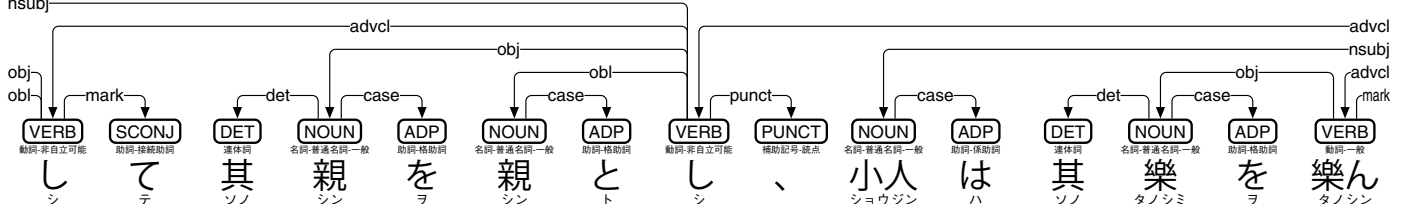
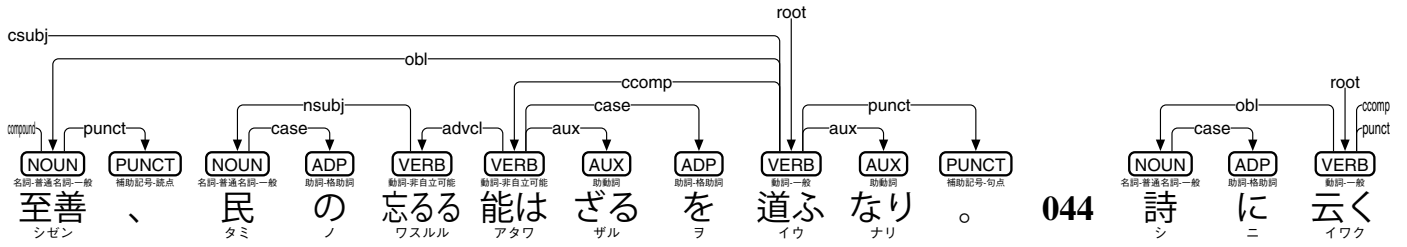

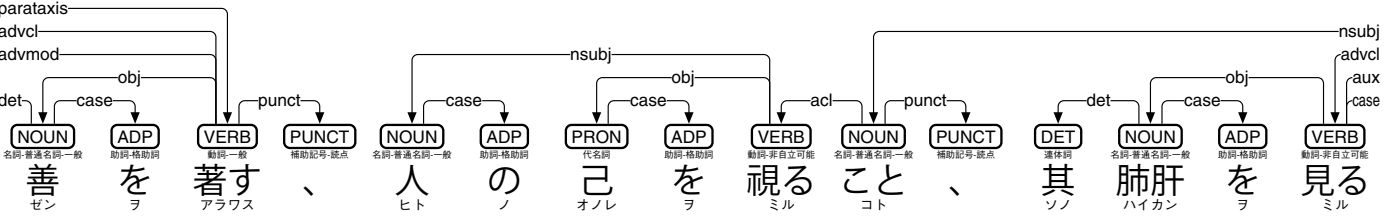
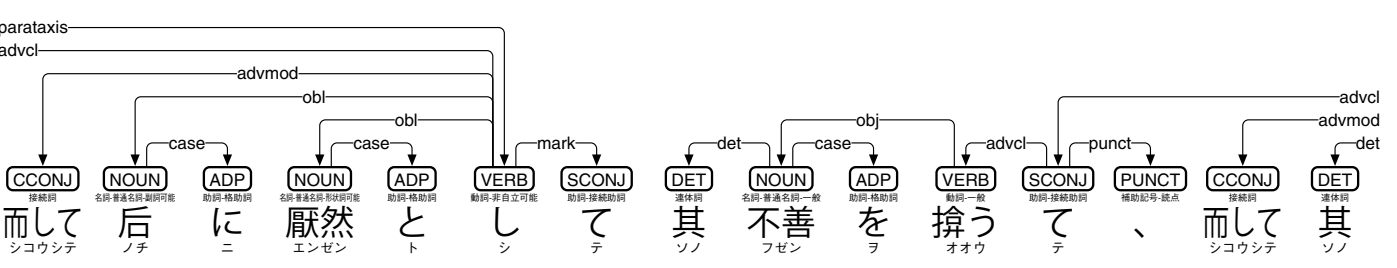
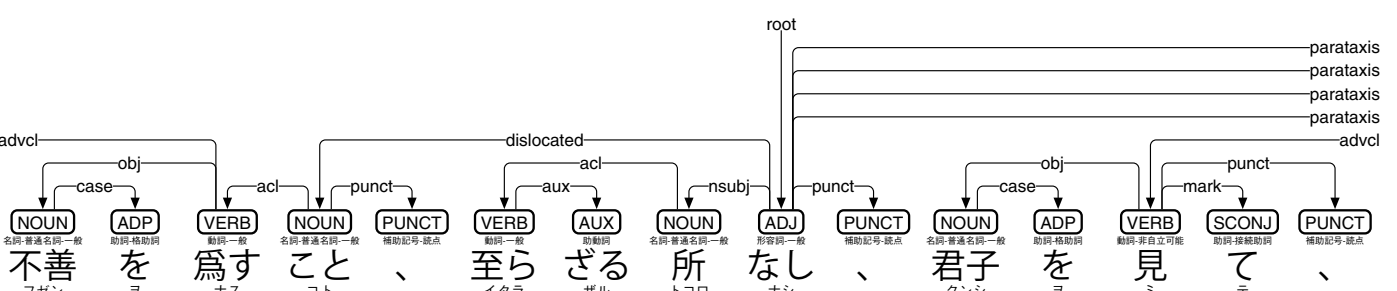
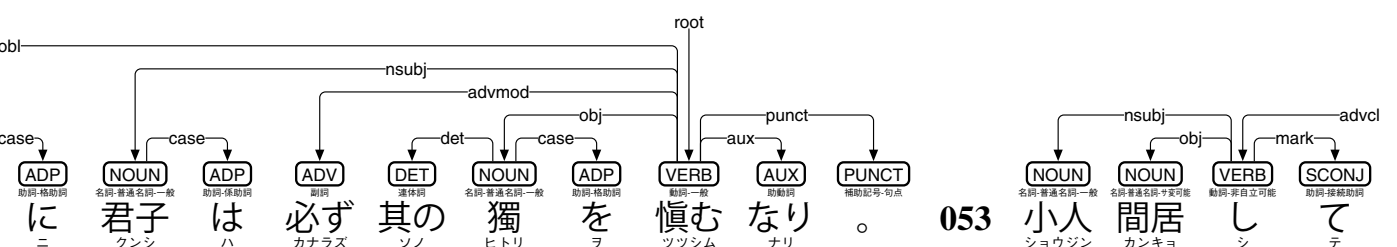
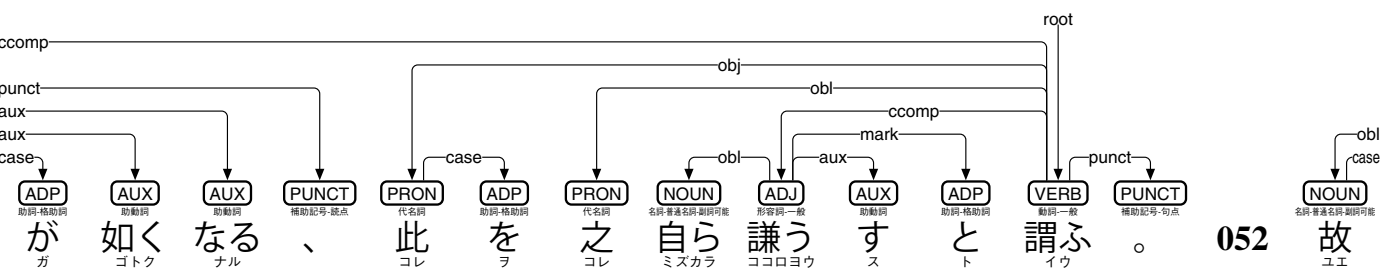
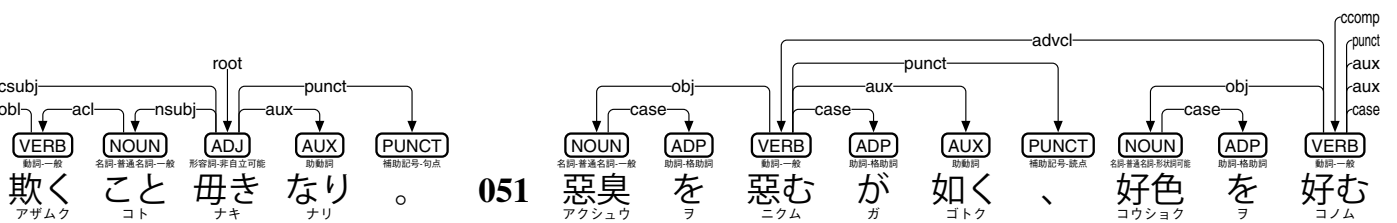
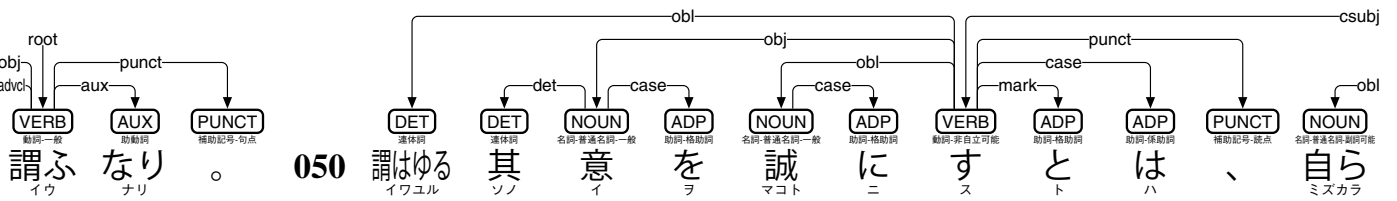
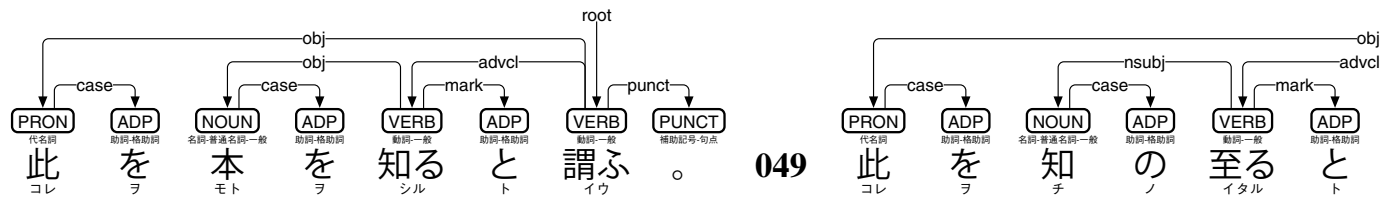

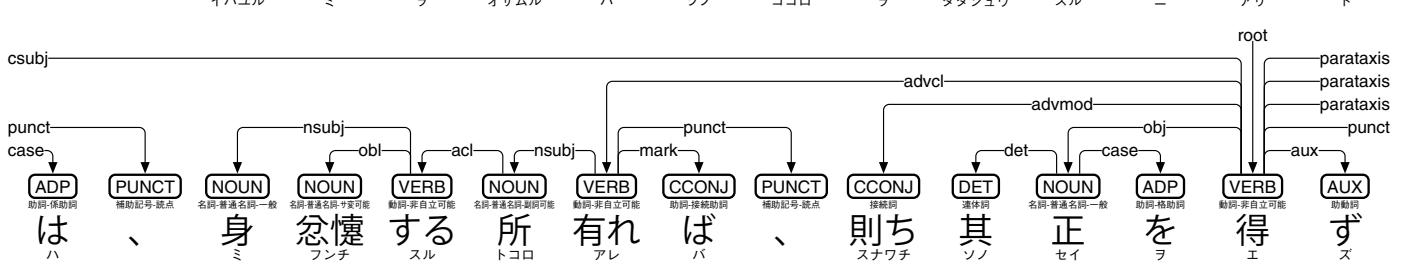
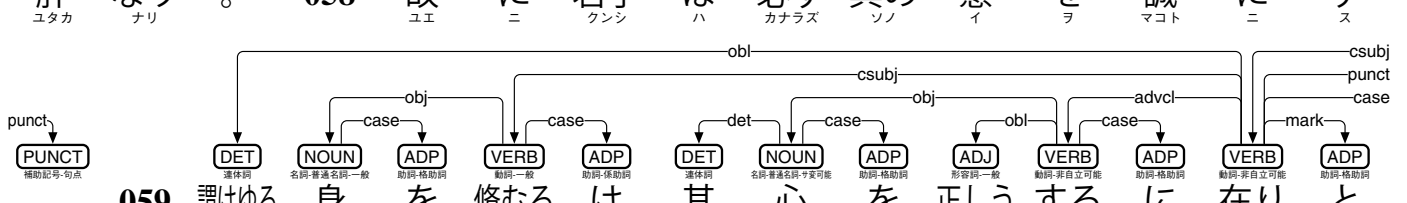
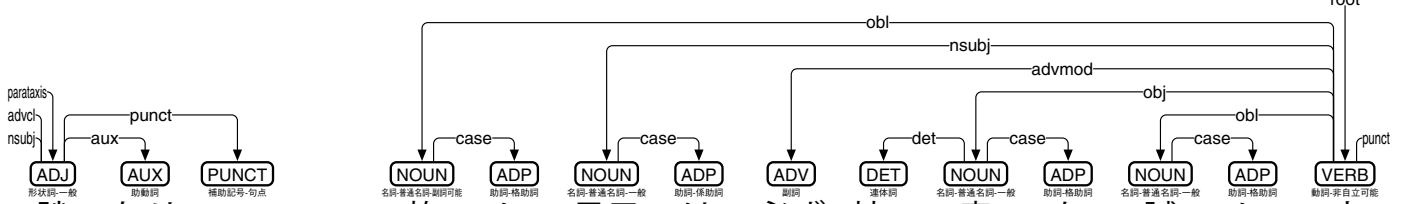
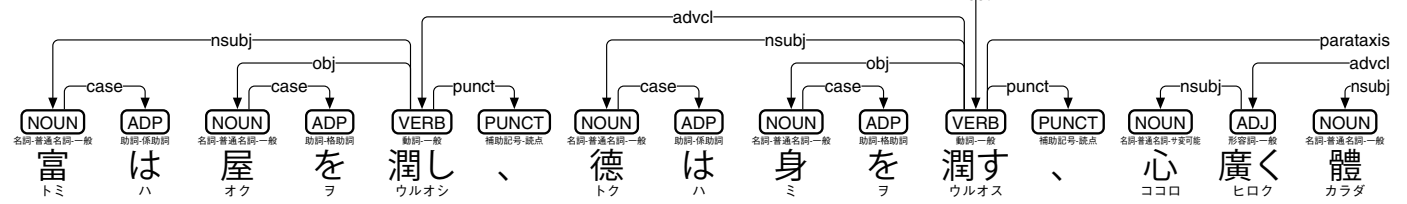
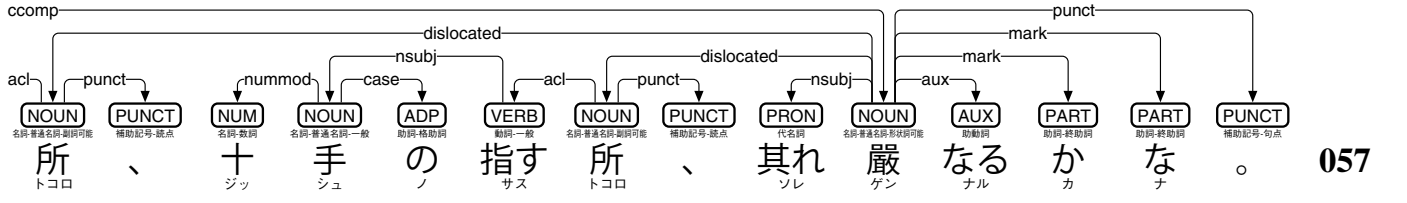
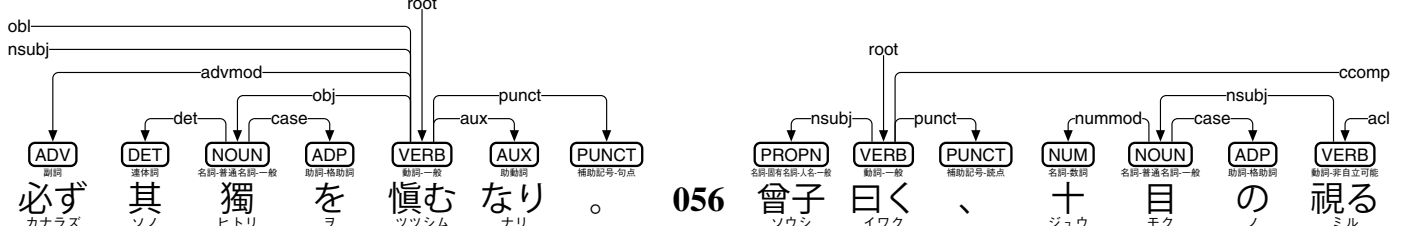
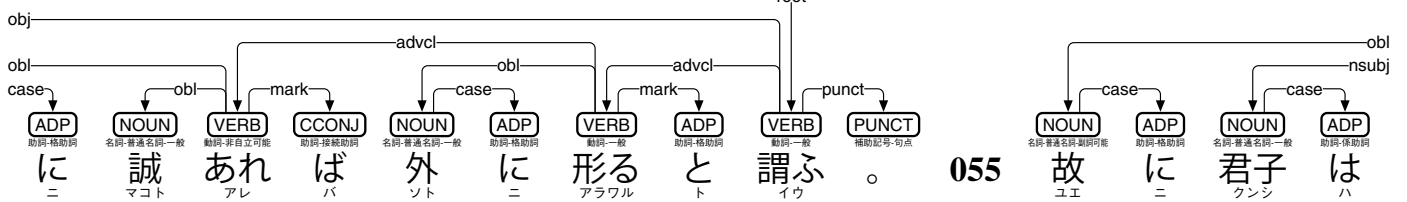
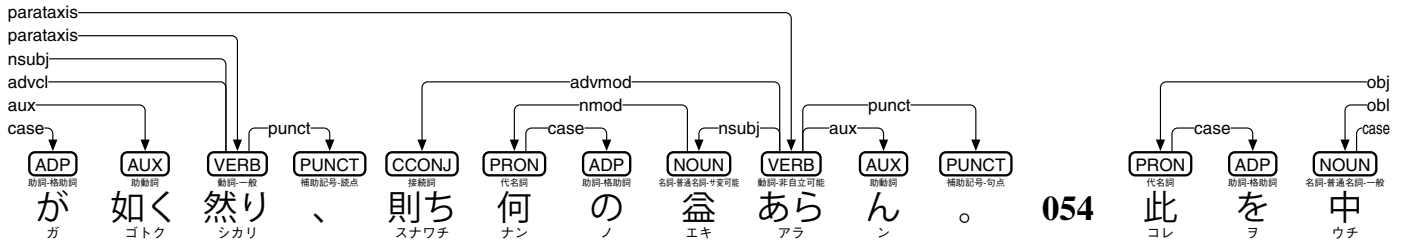

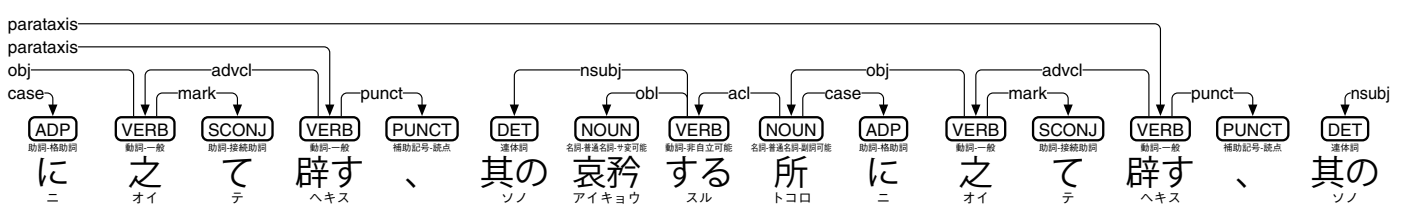
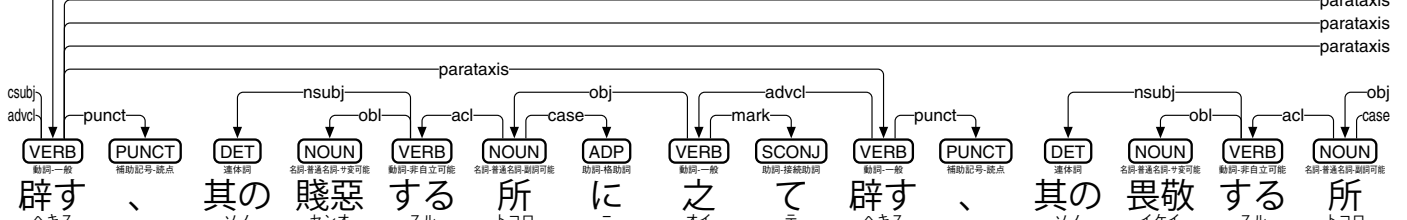
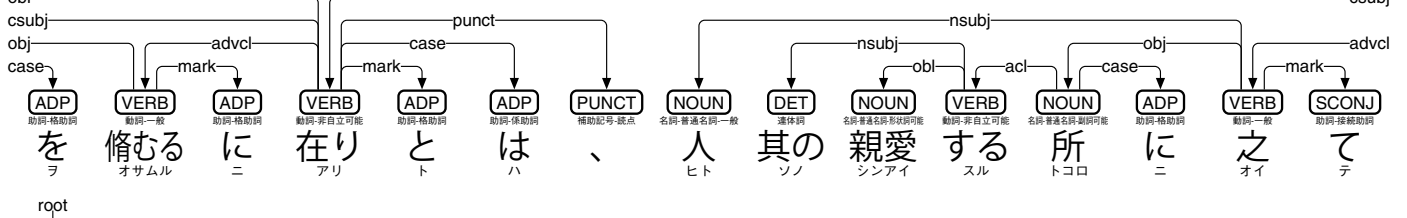
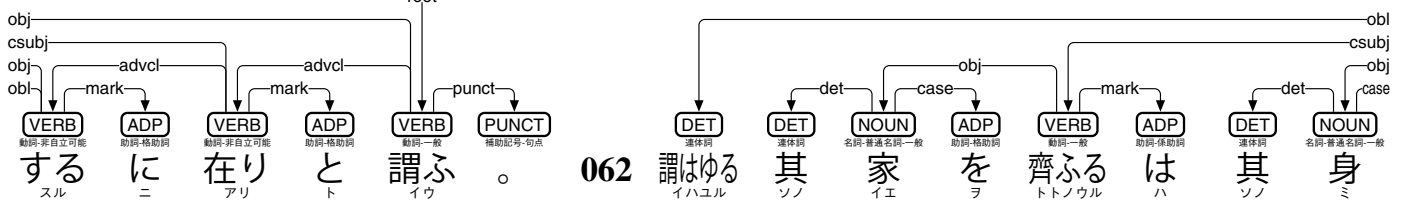
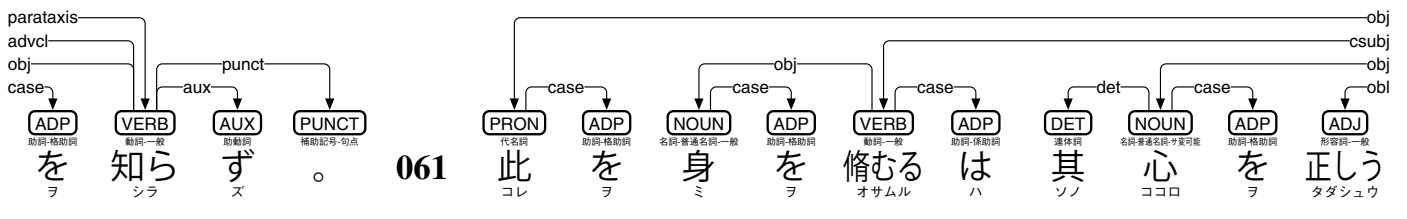
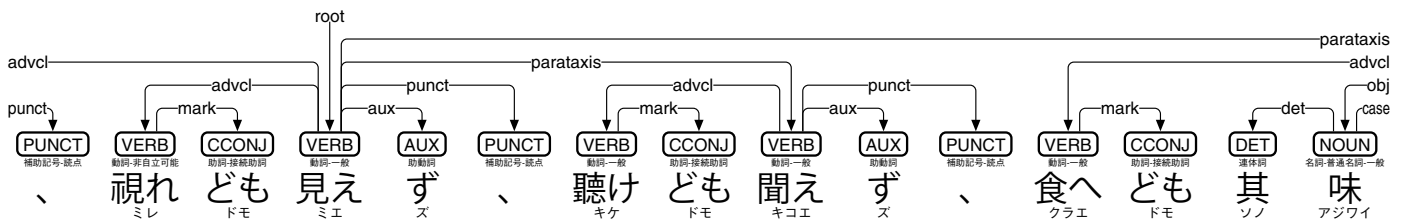
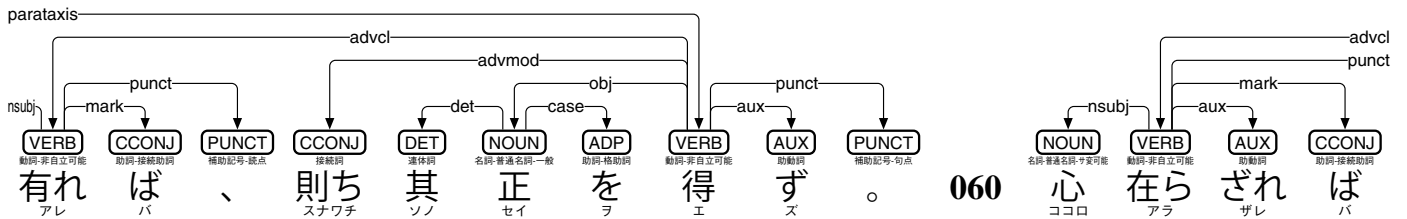
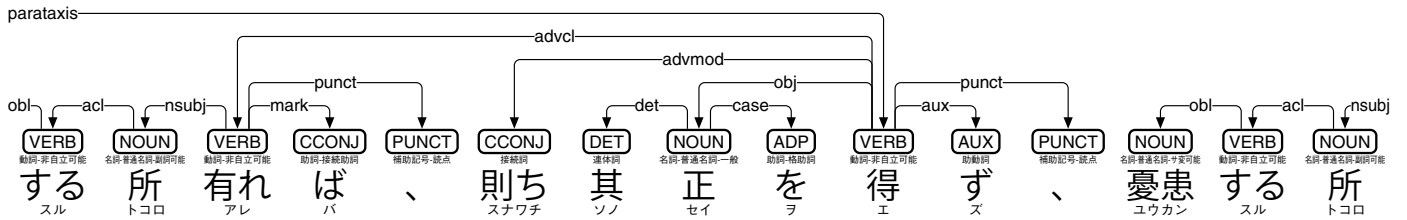
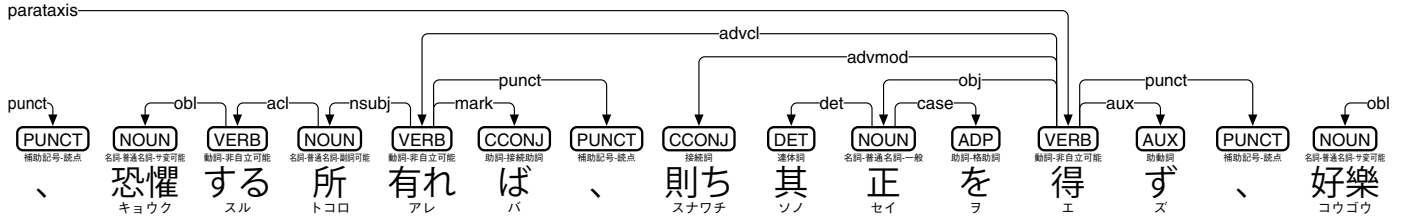

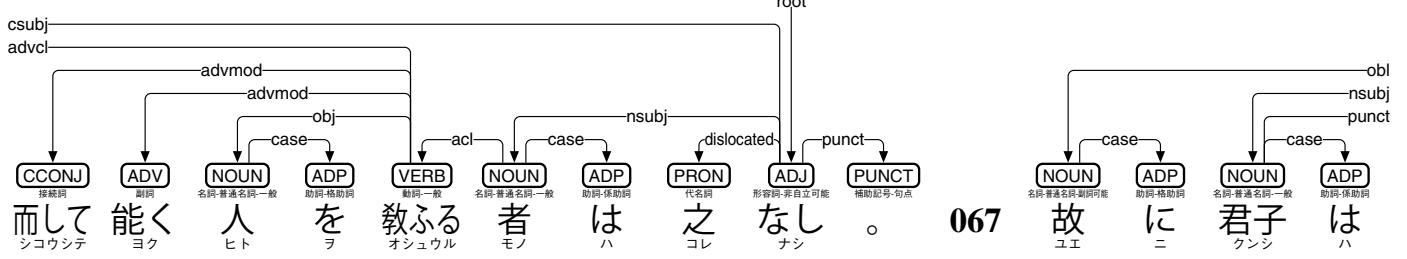
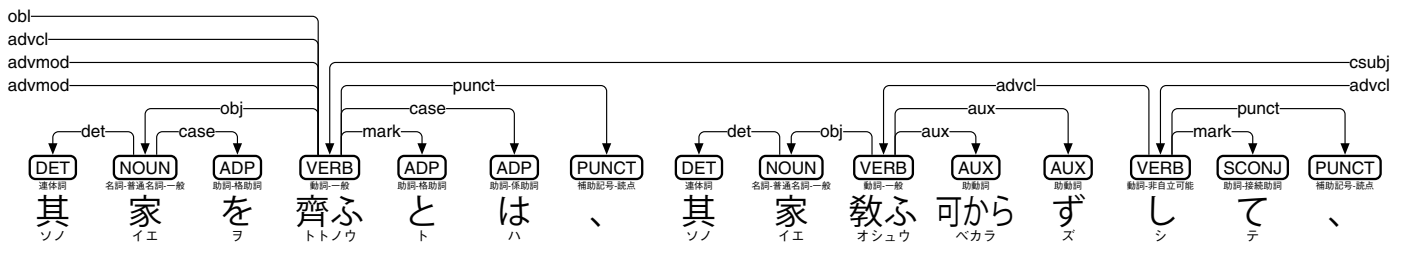
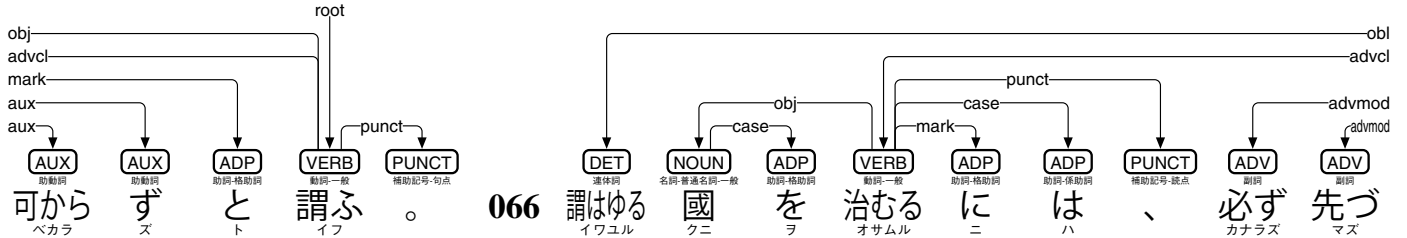
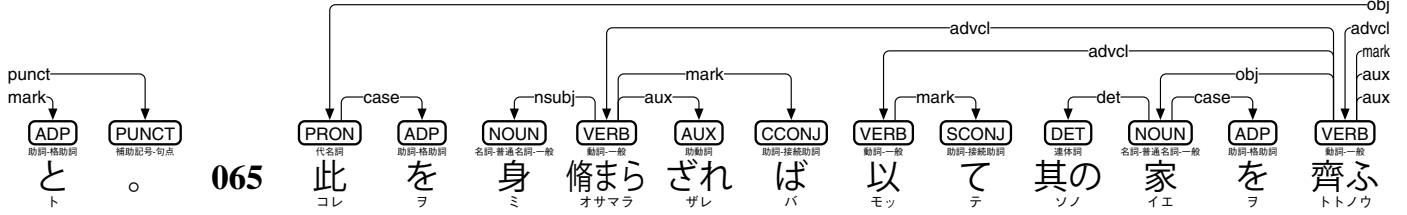
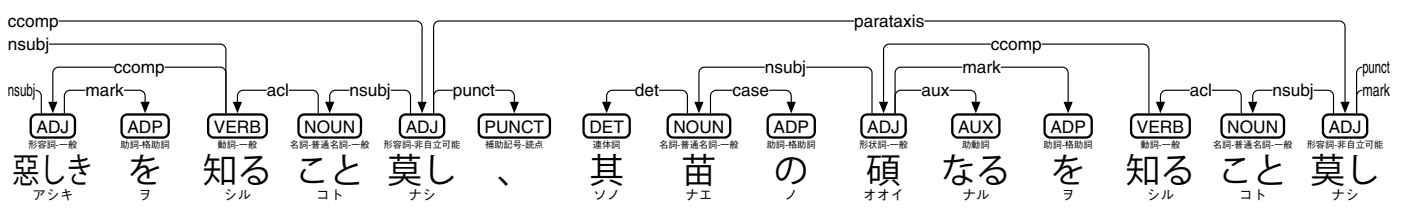
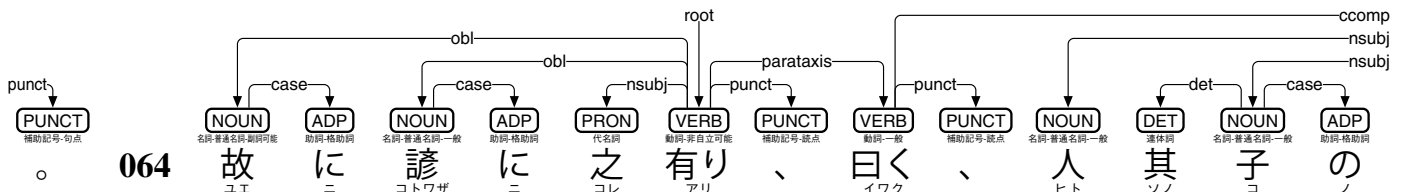
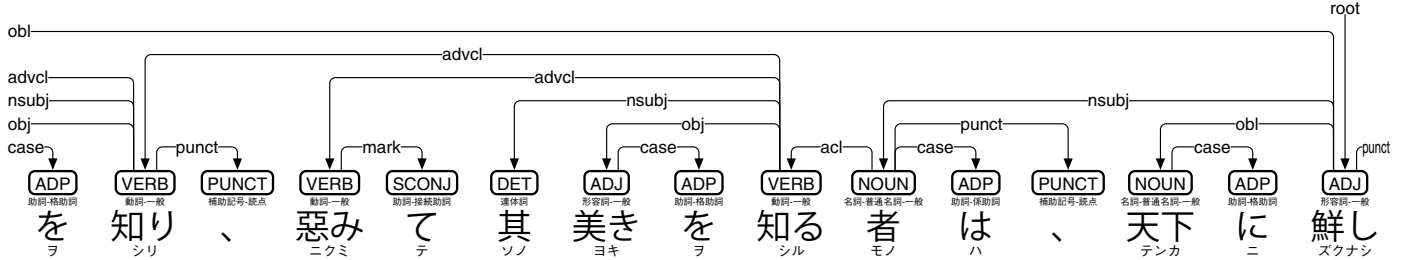
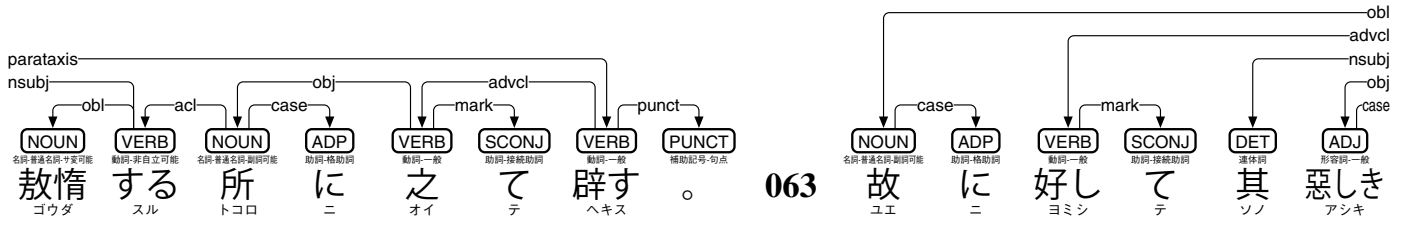

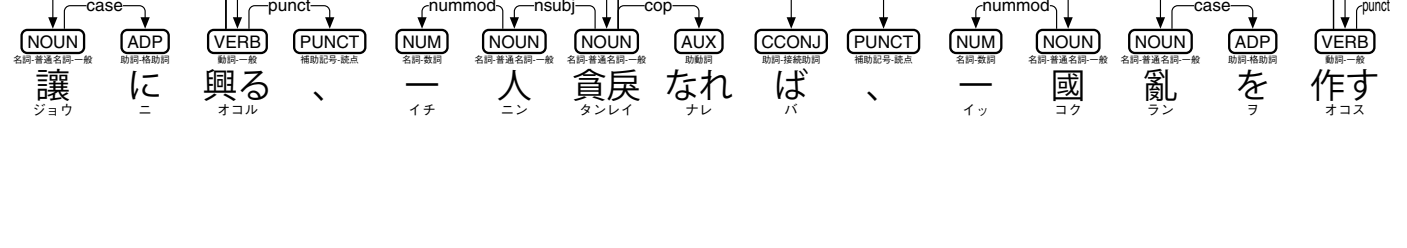
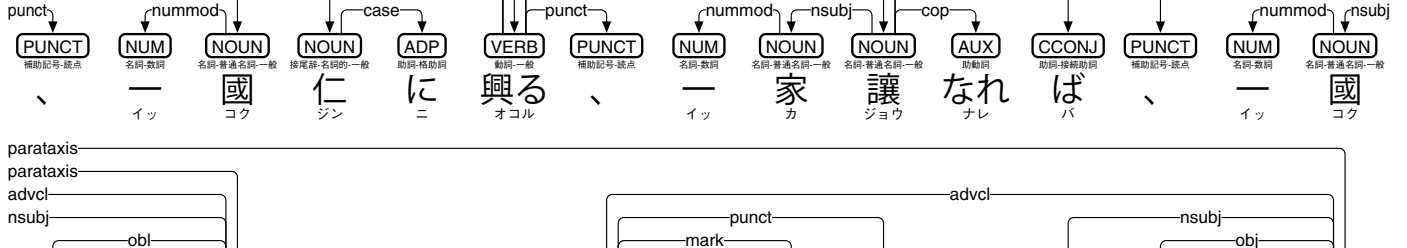
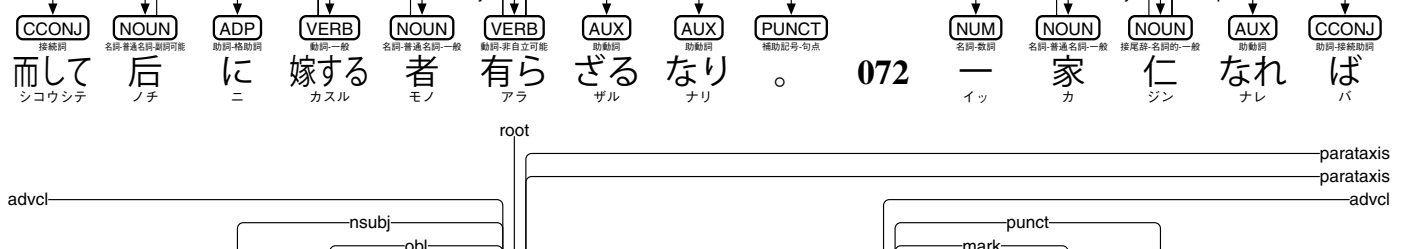
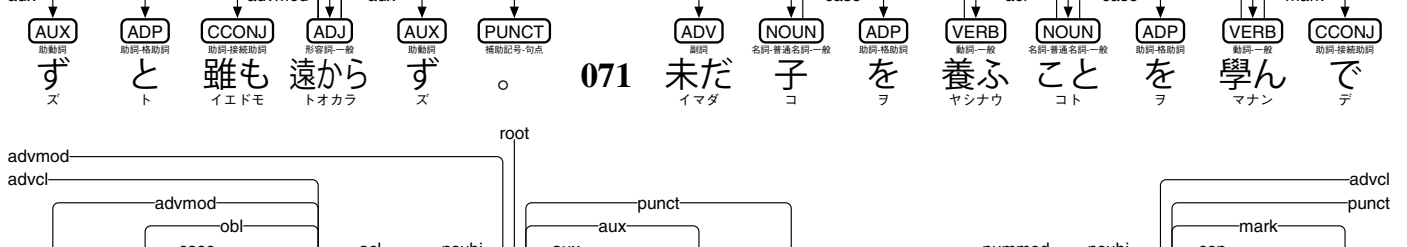
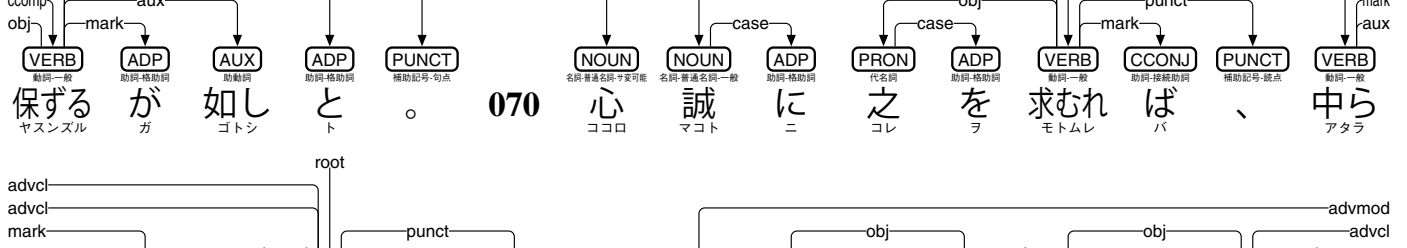
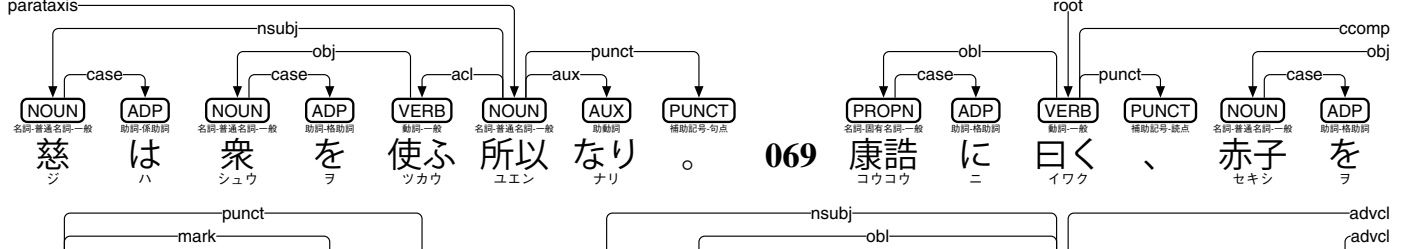
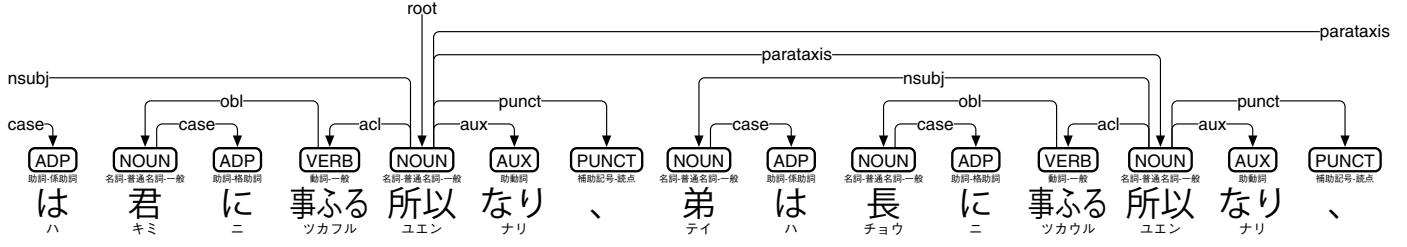
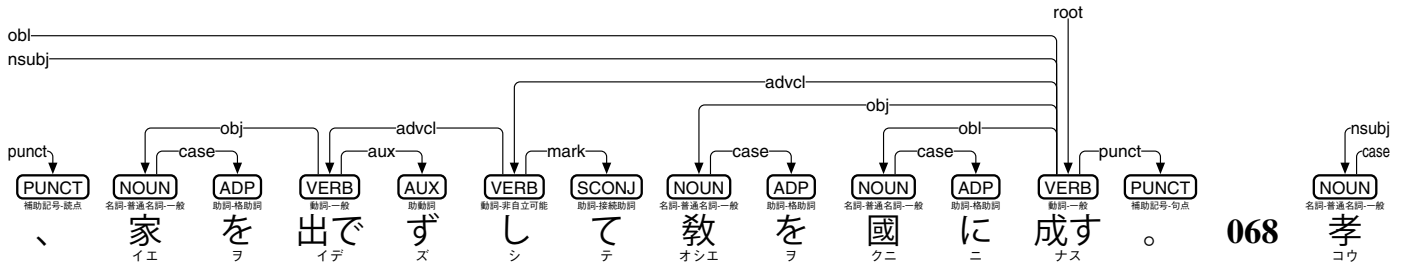

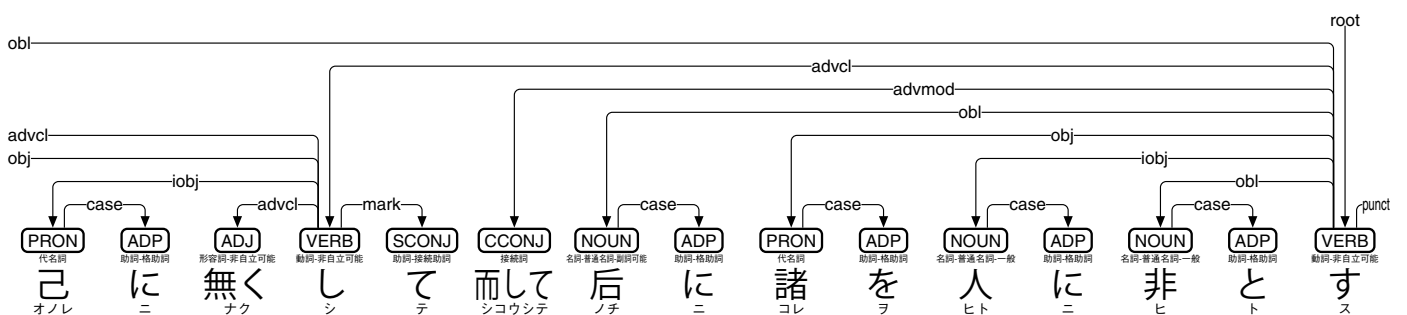
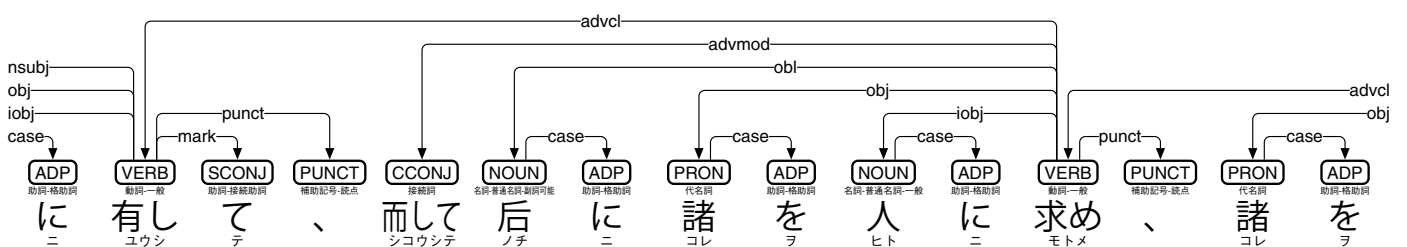
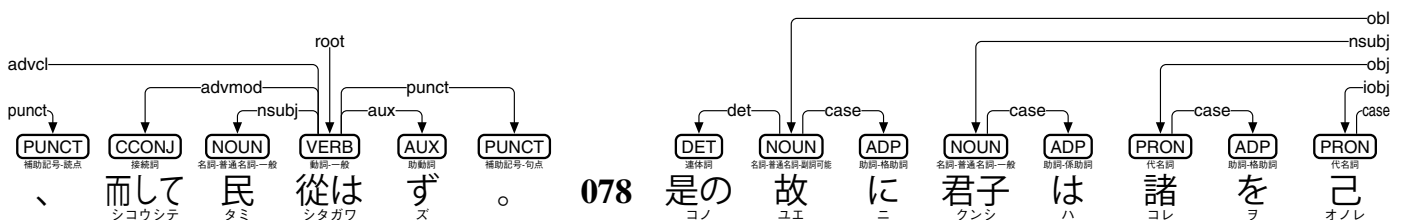
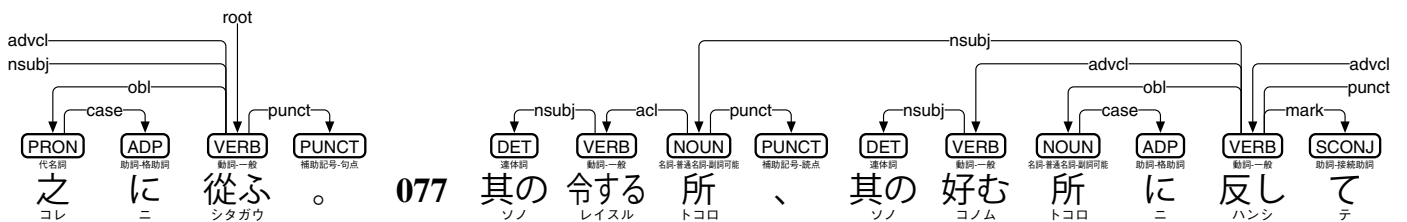
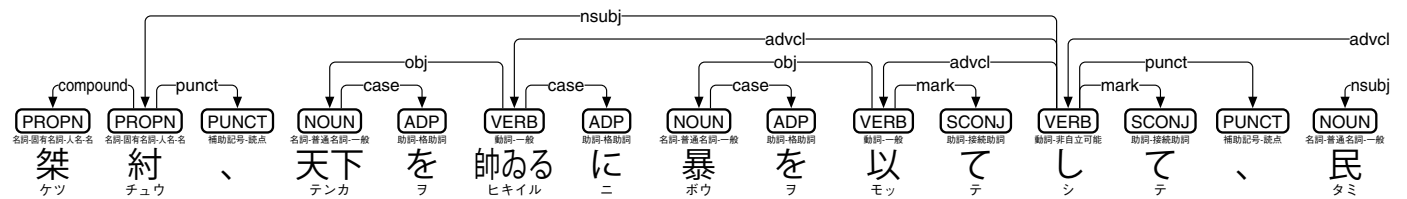
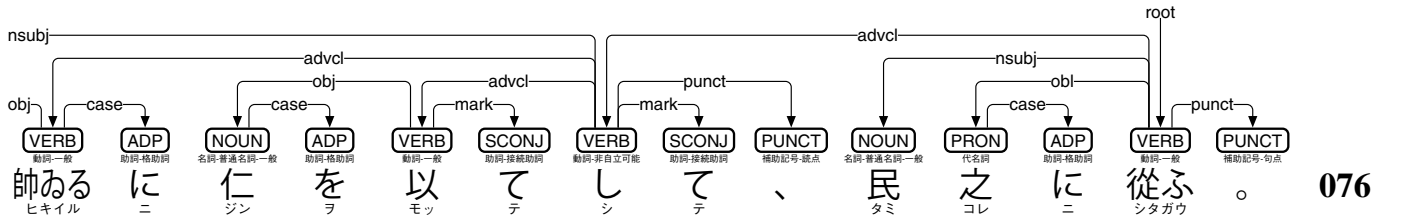
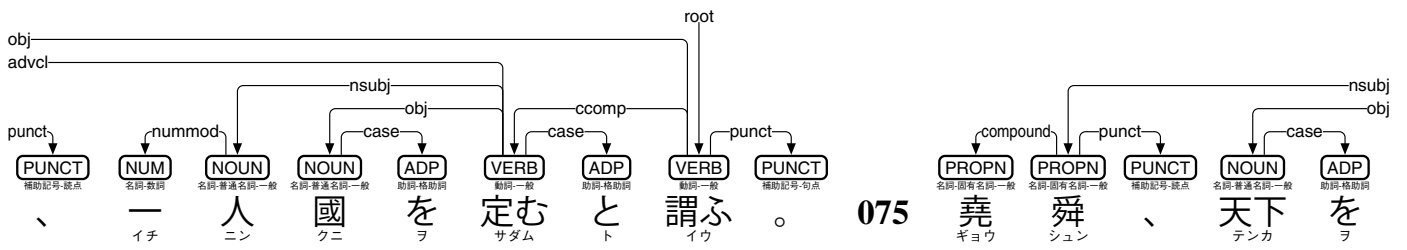
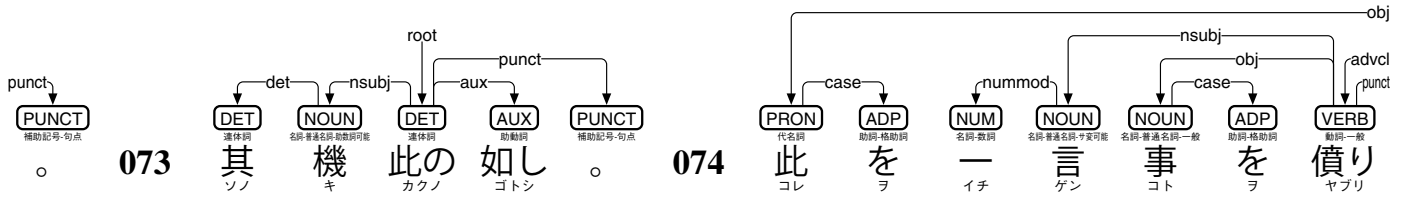

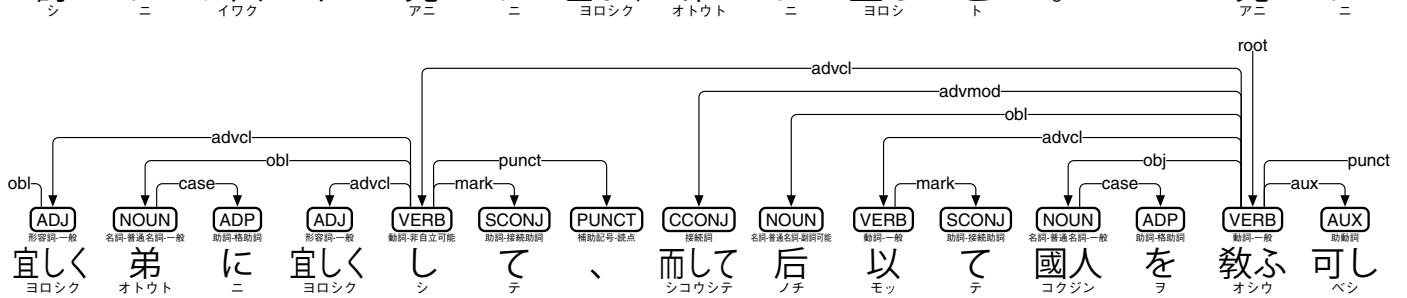
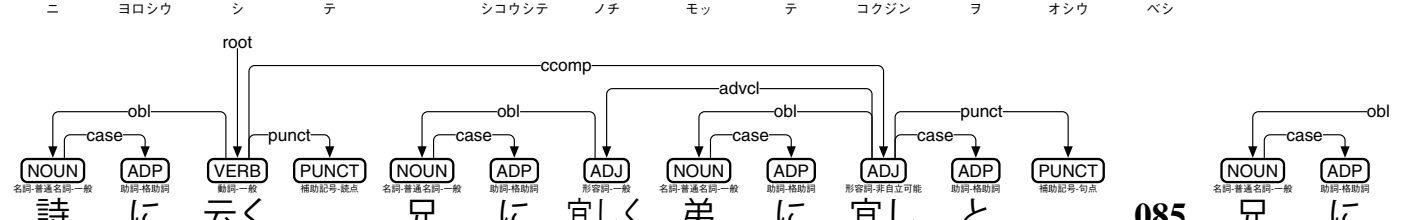
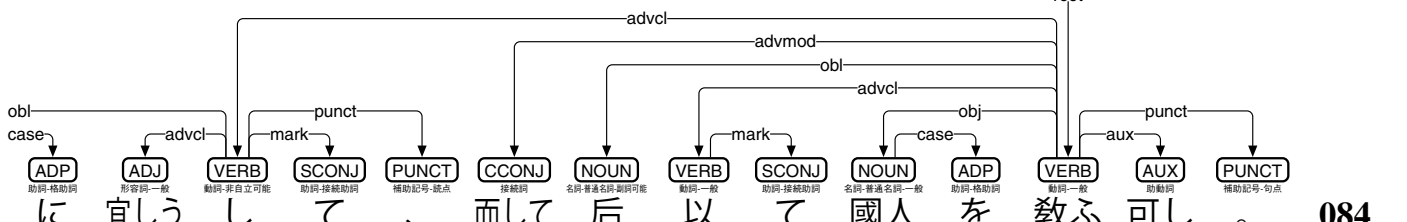
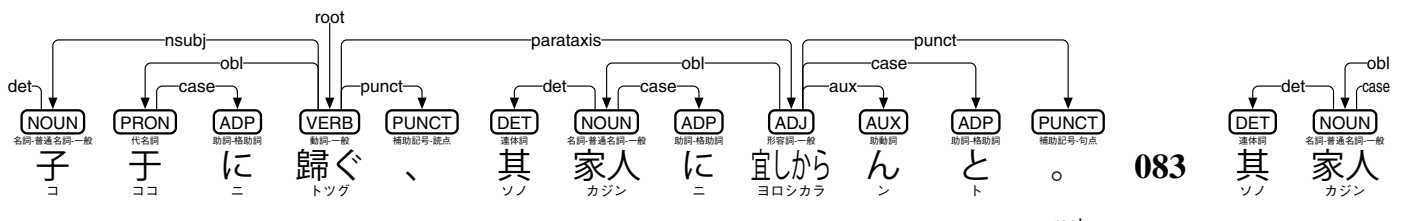
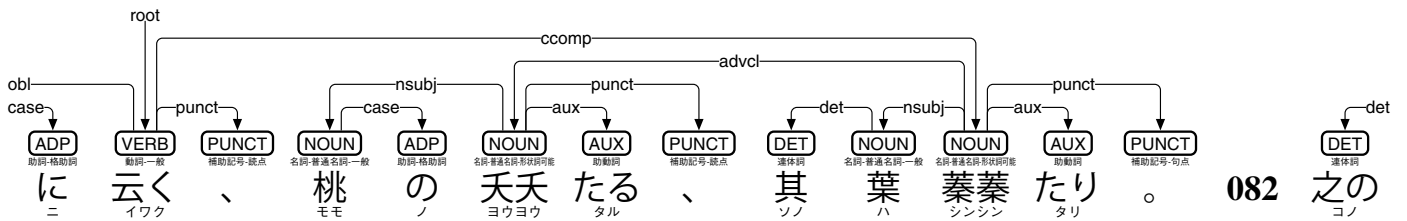
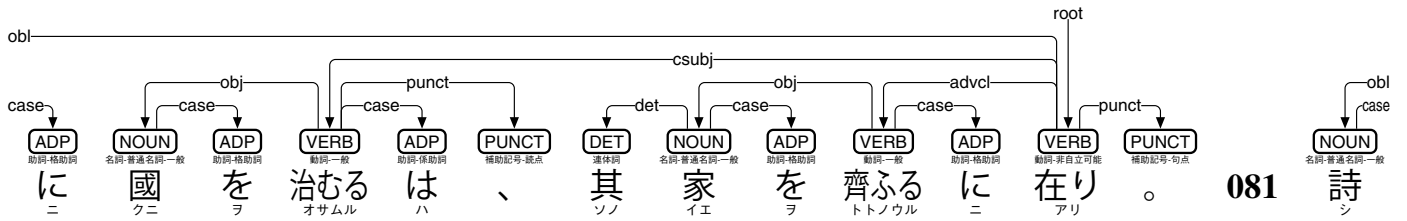
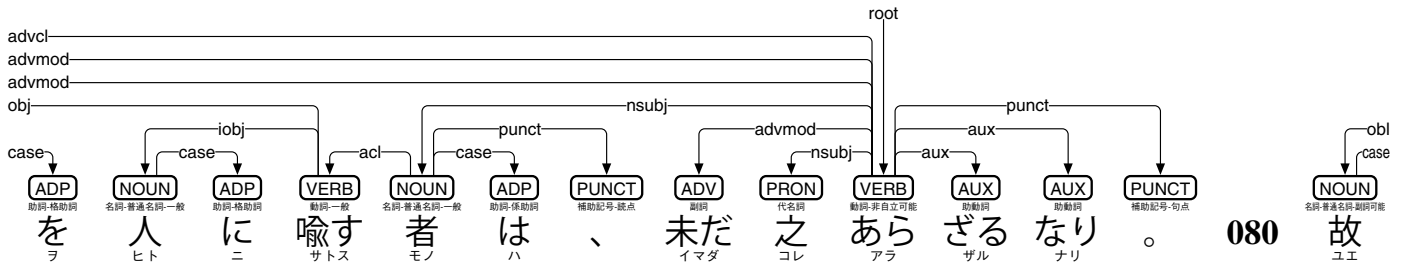
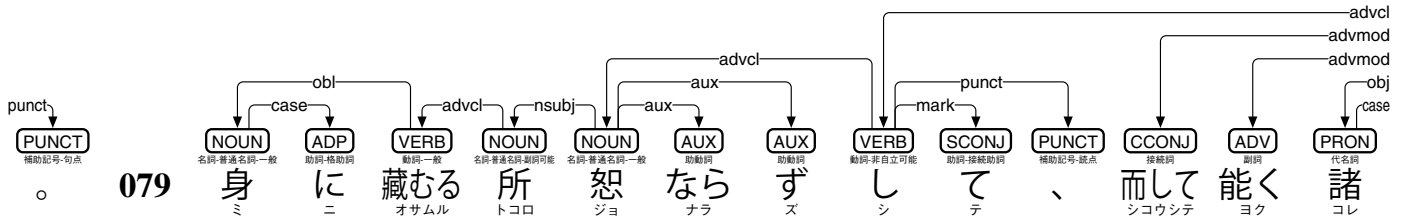

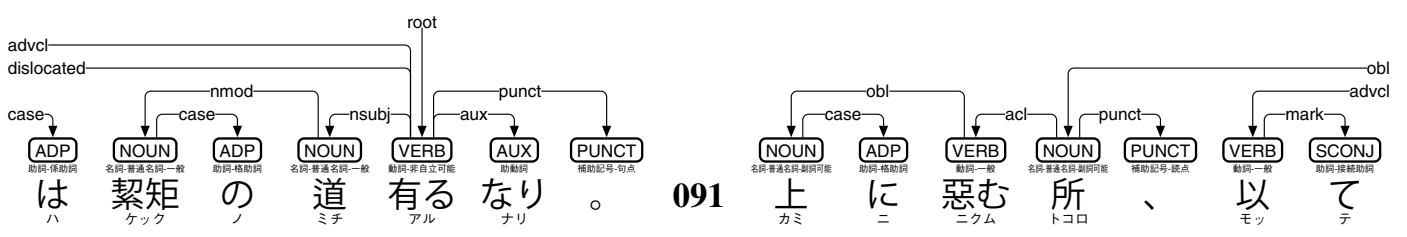
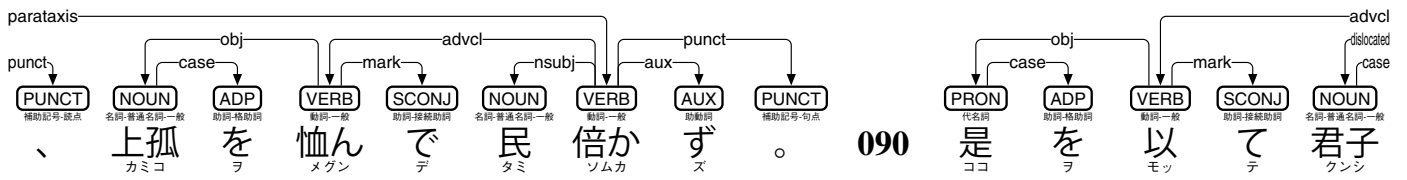
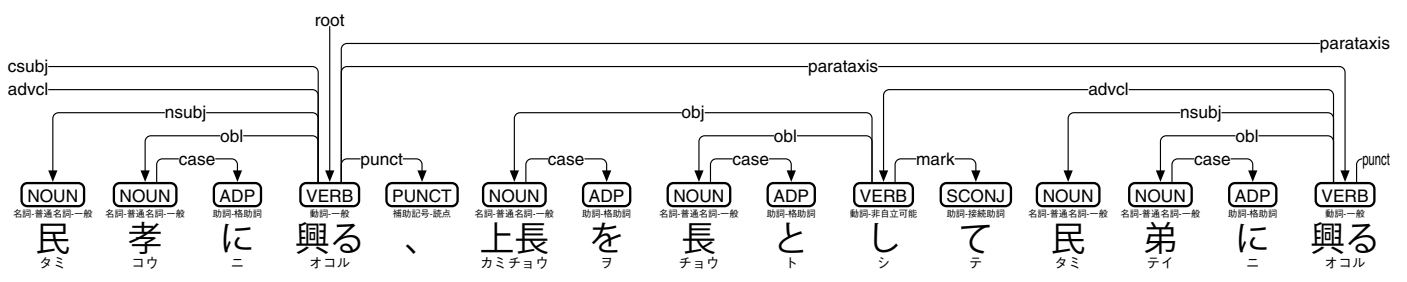
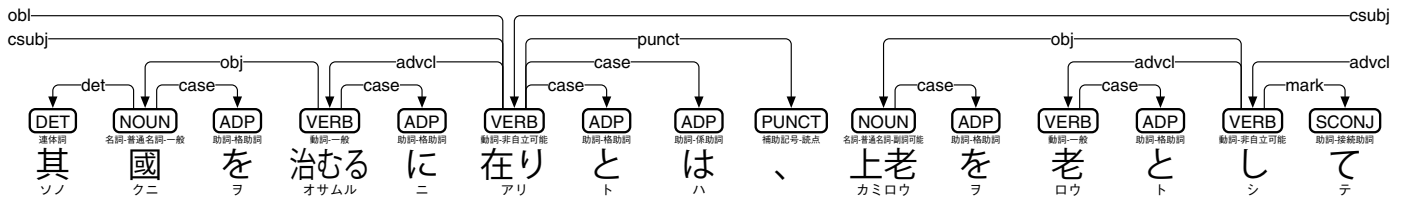
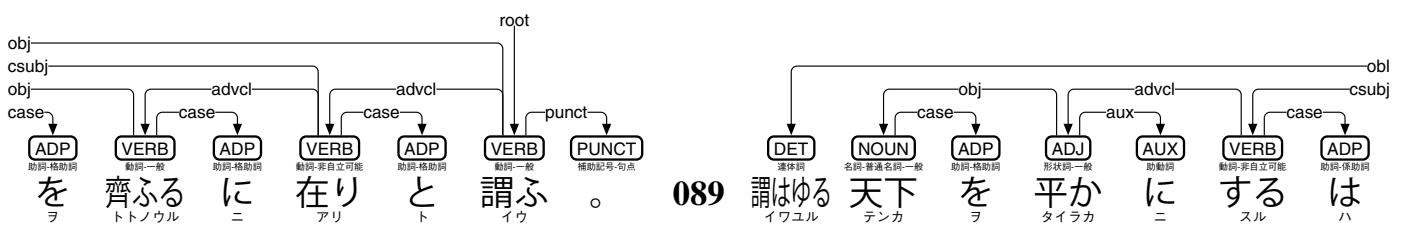
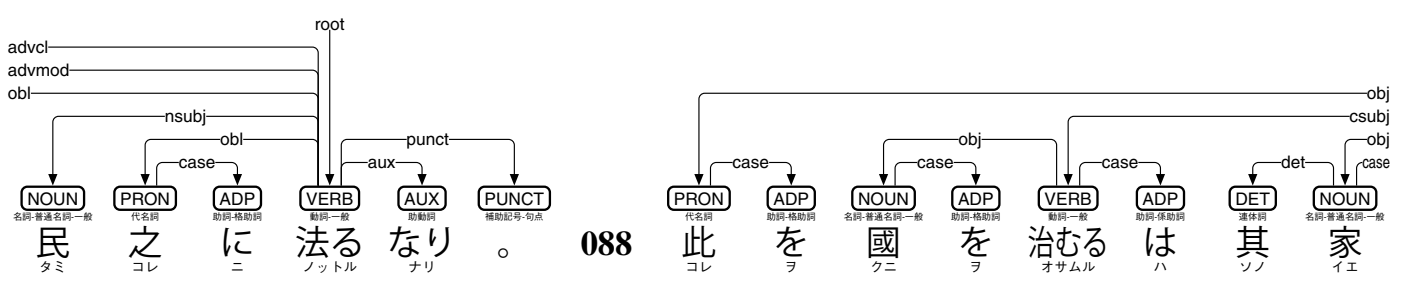
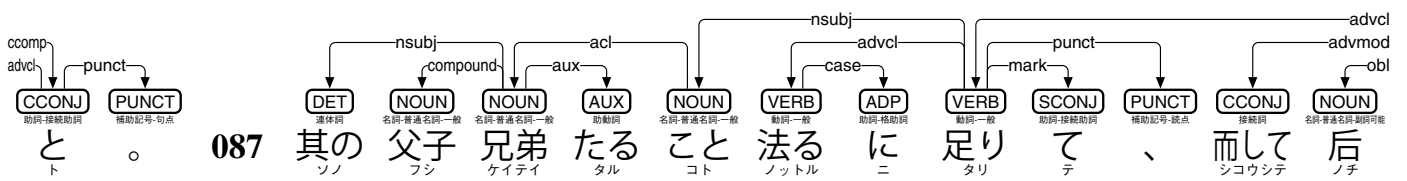
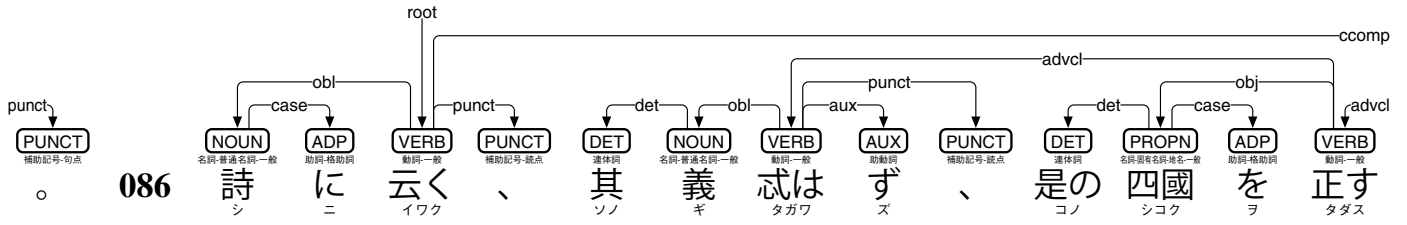

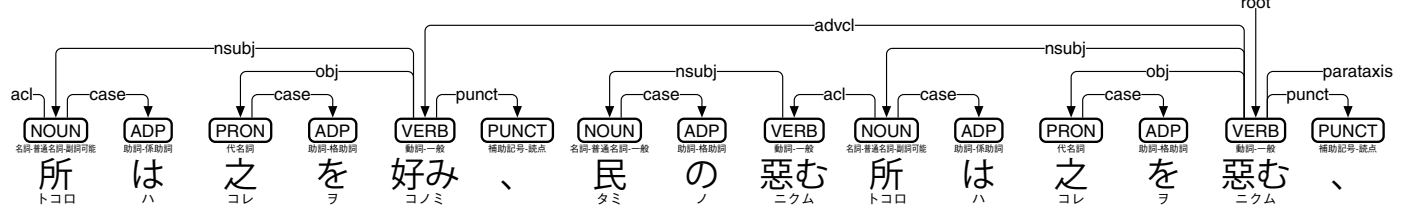
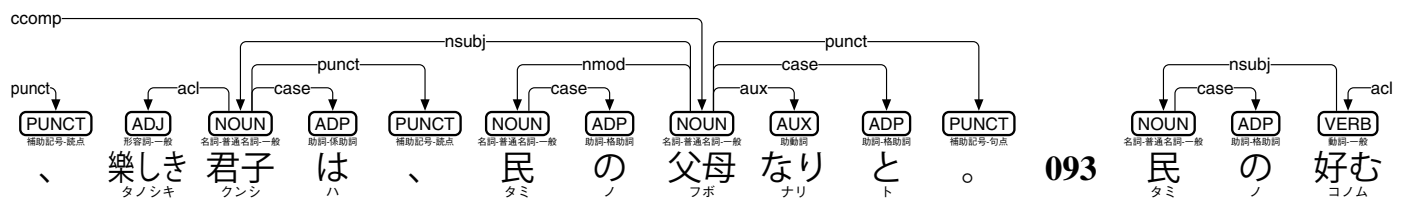
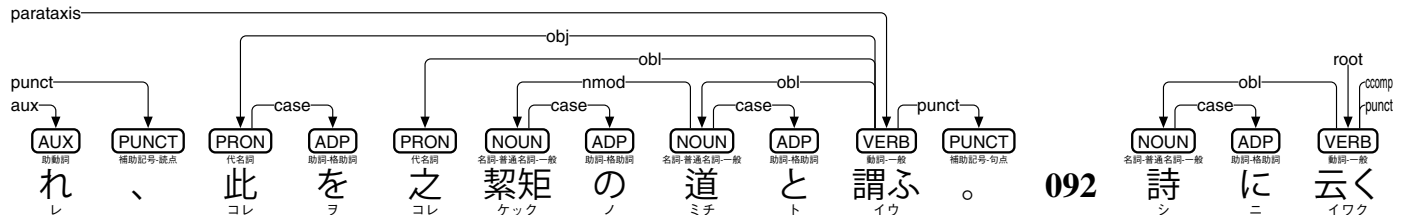
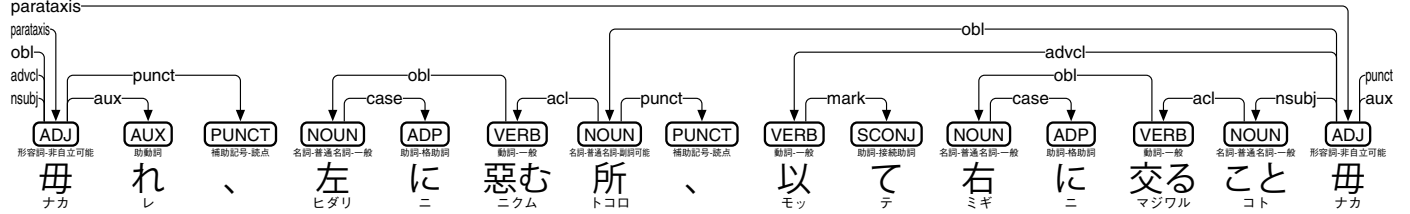
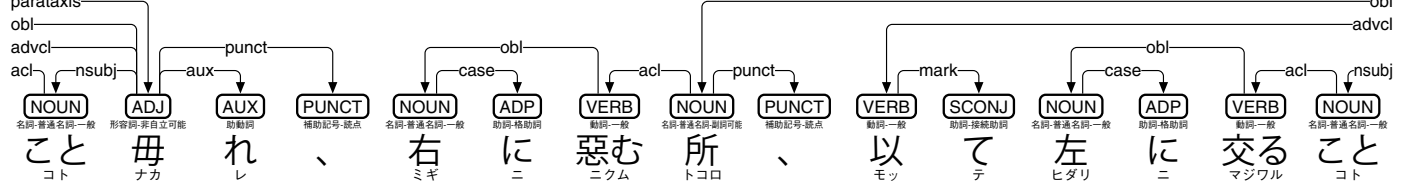
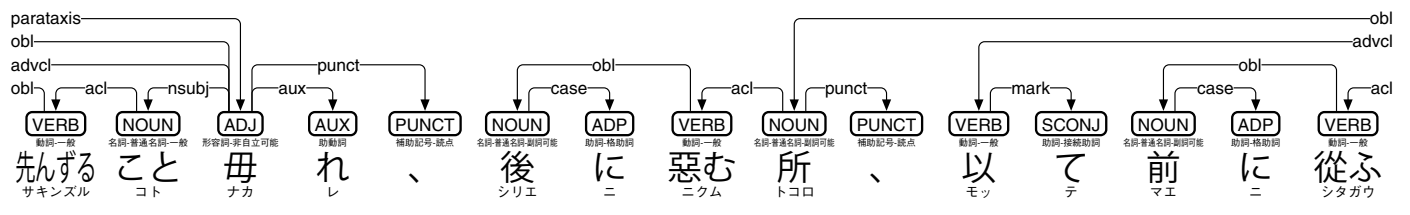
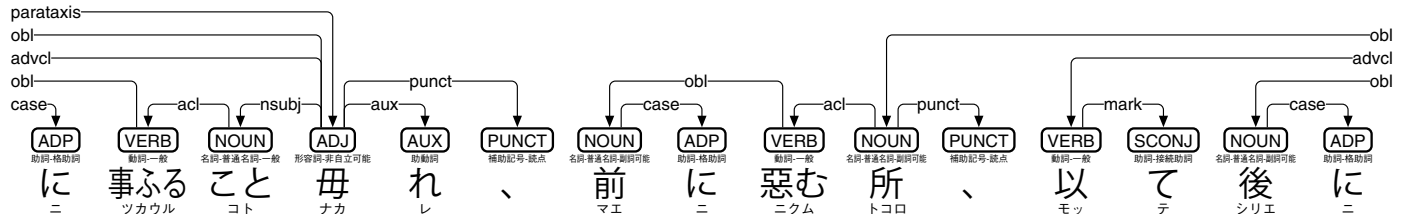
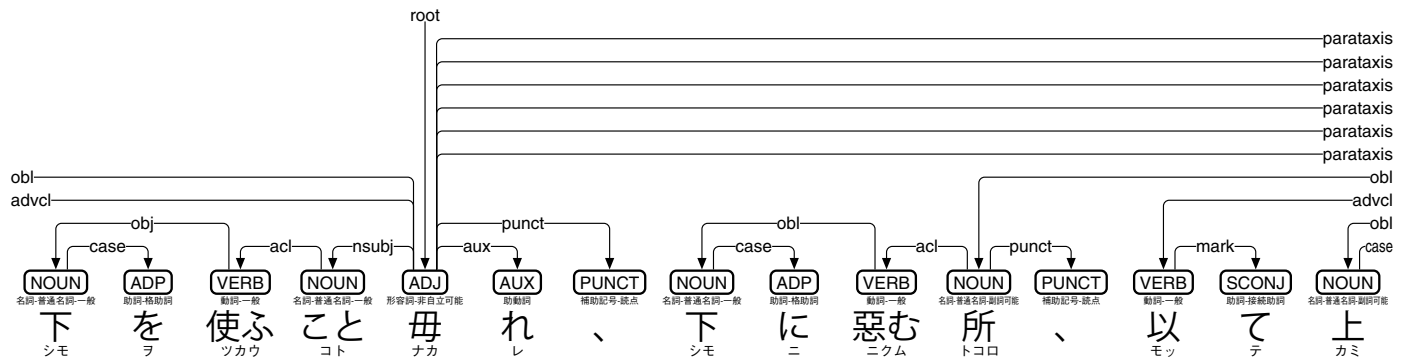

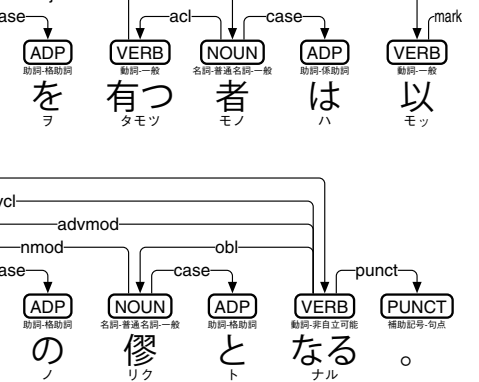
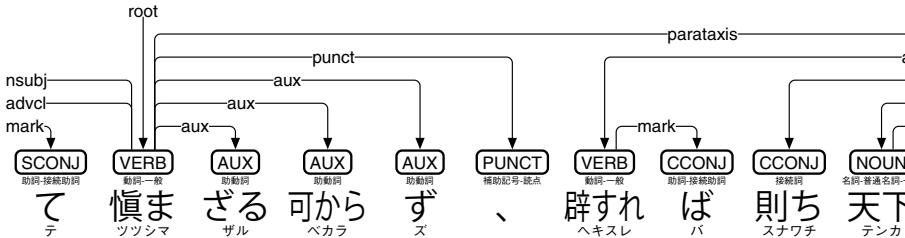
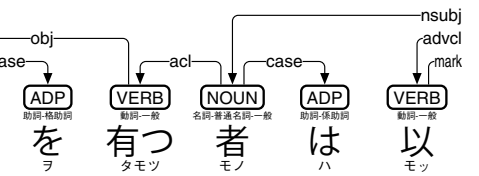
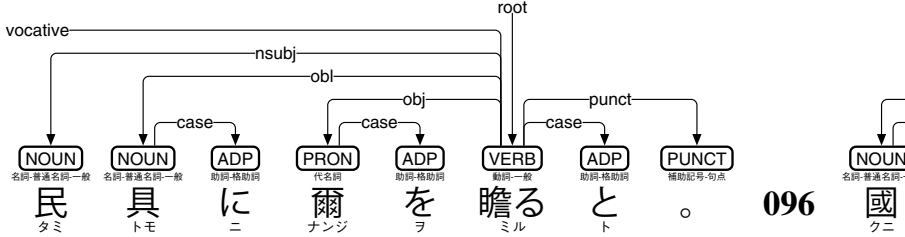
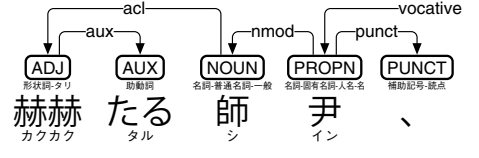
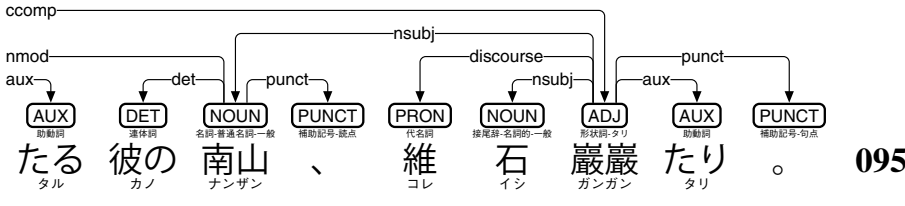
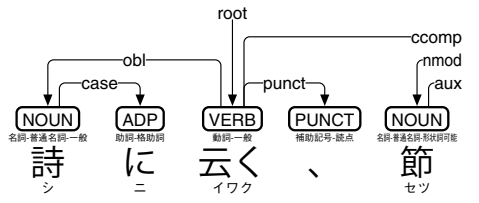
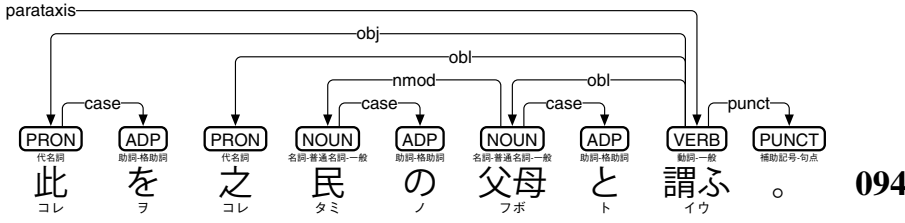

097

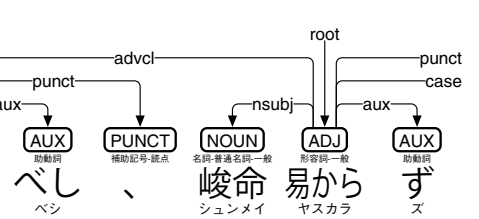
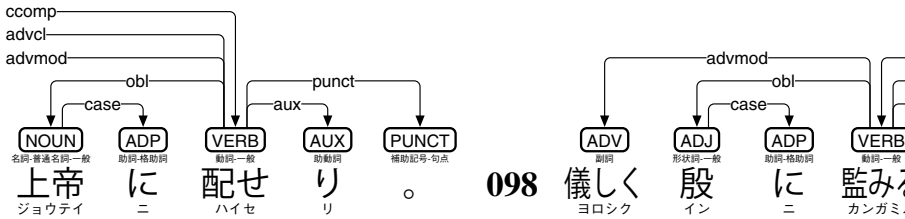
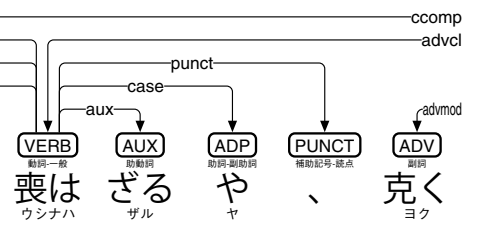
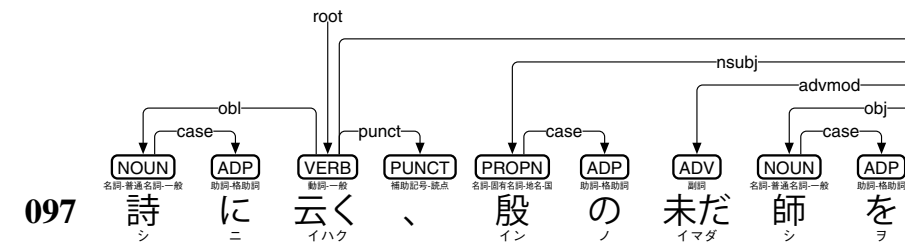

098

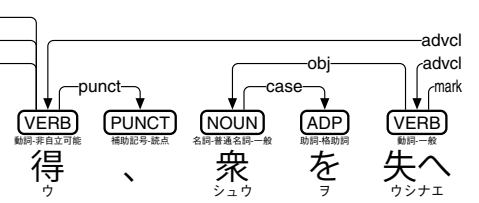
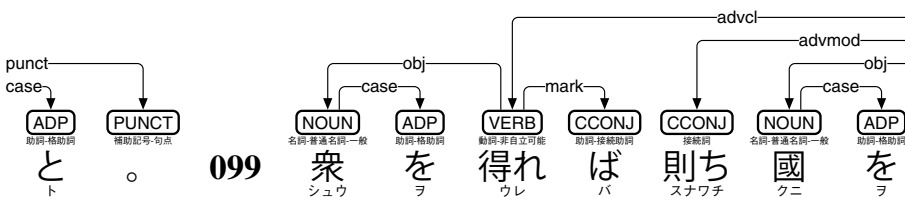

099

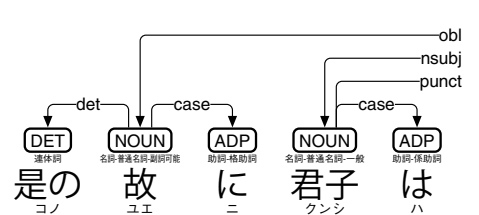
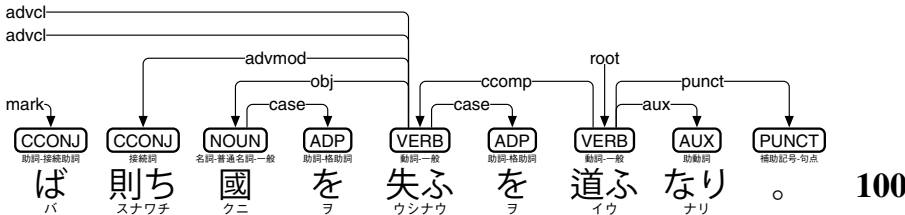

100

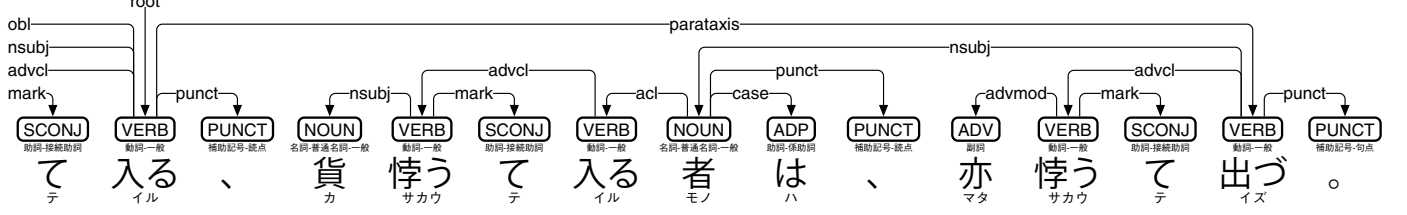
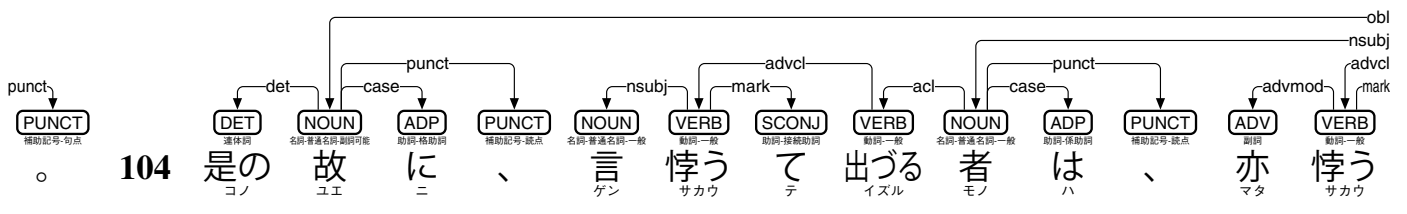
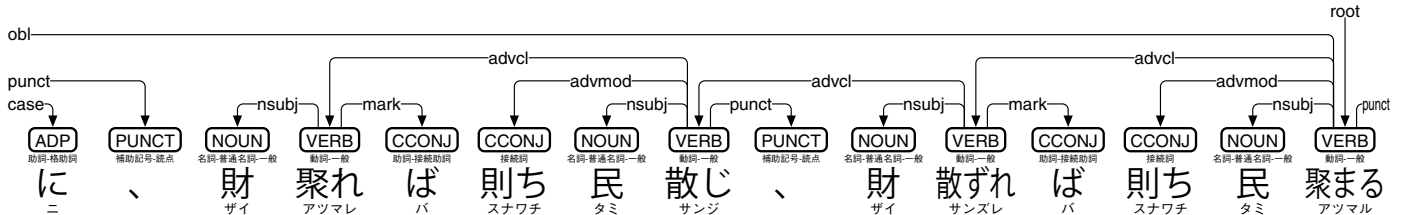
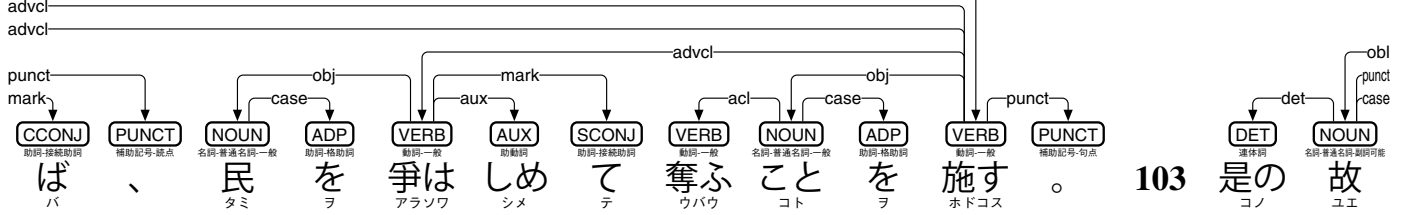
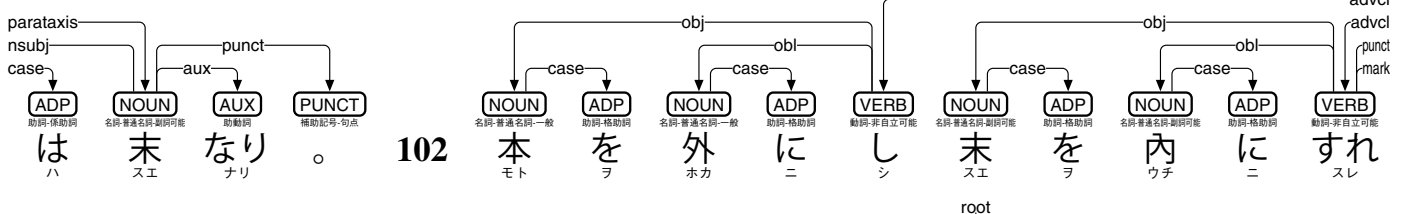
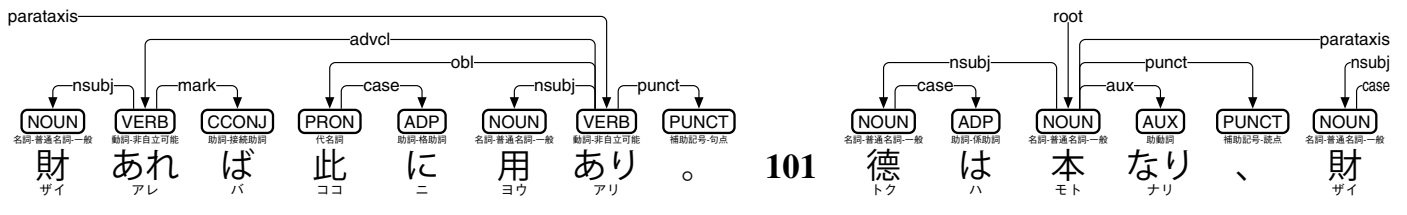
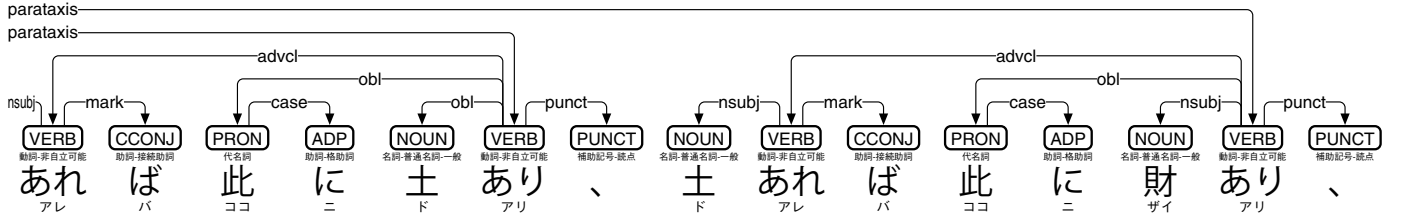
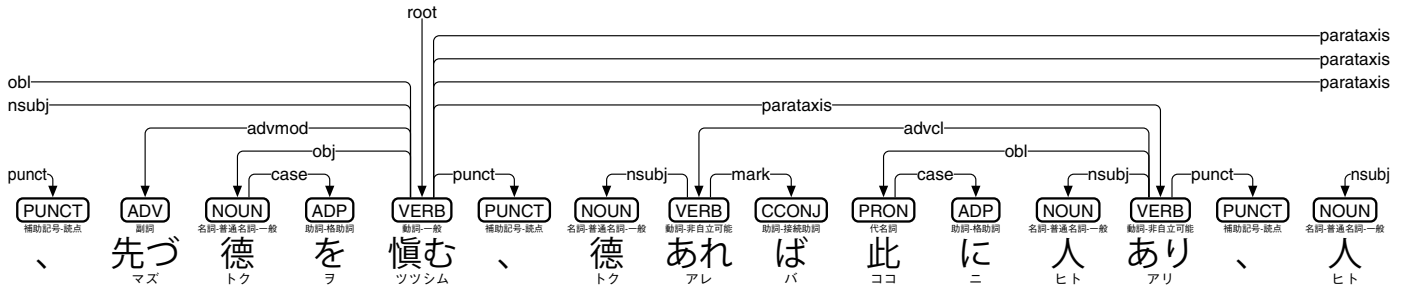

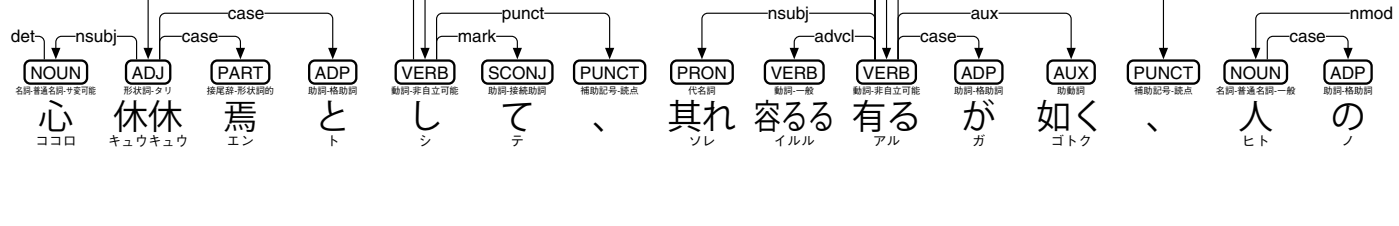
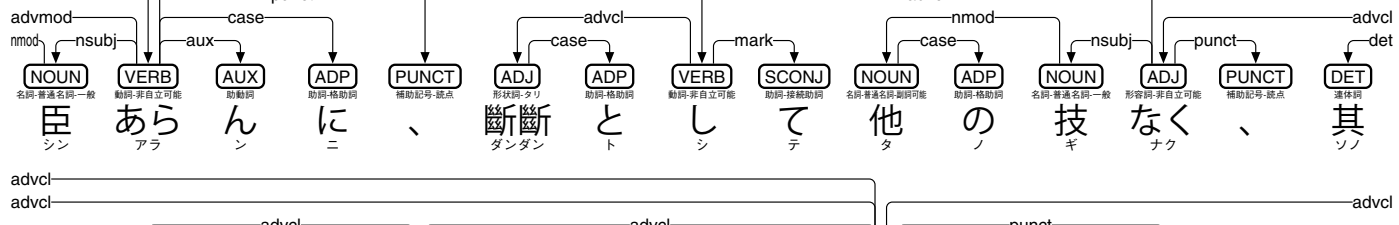
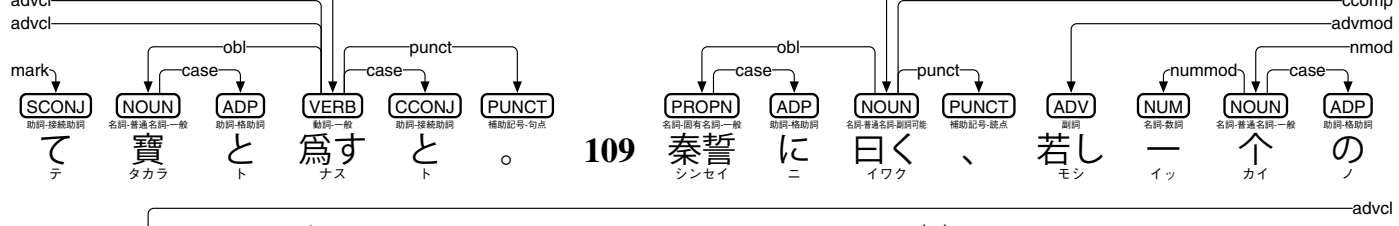
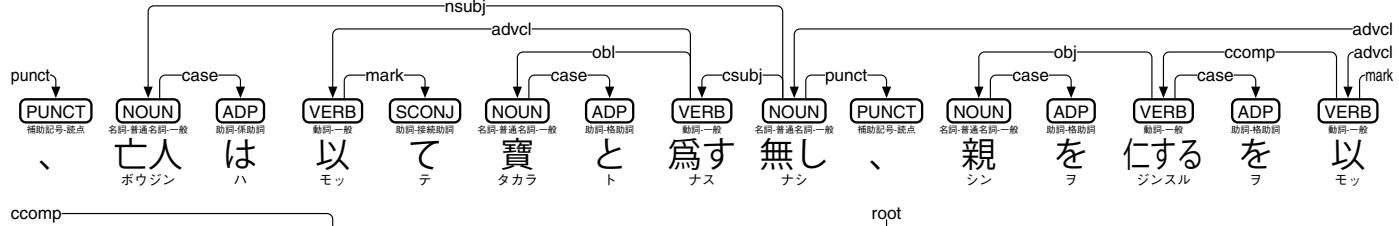
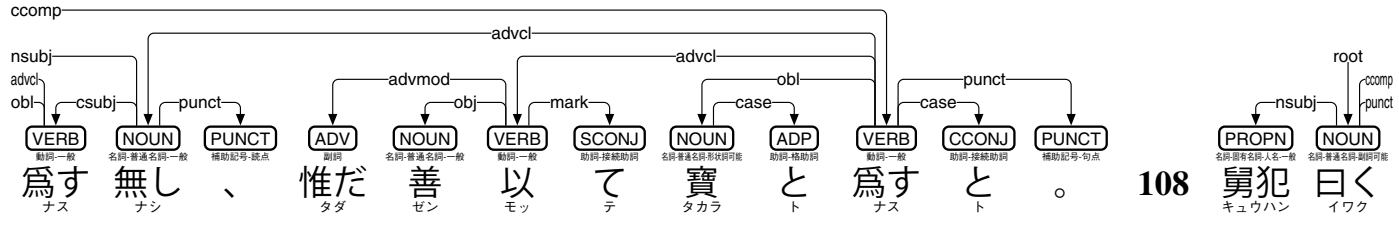
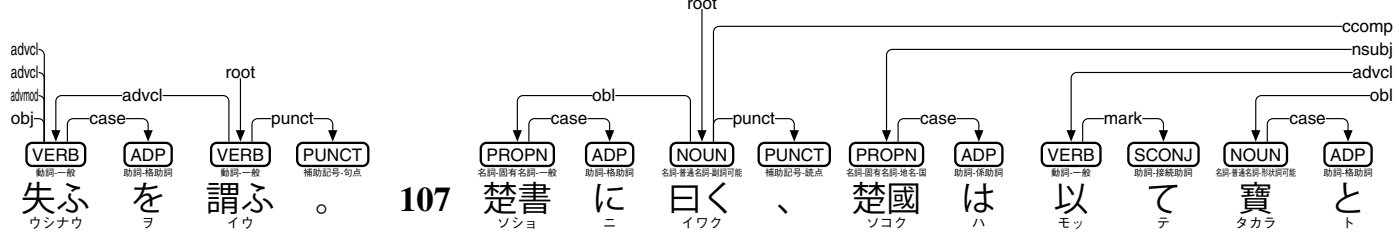
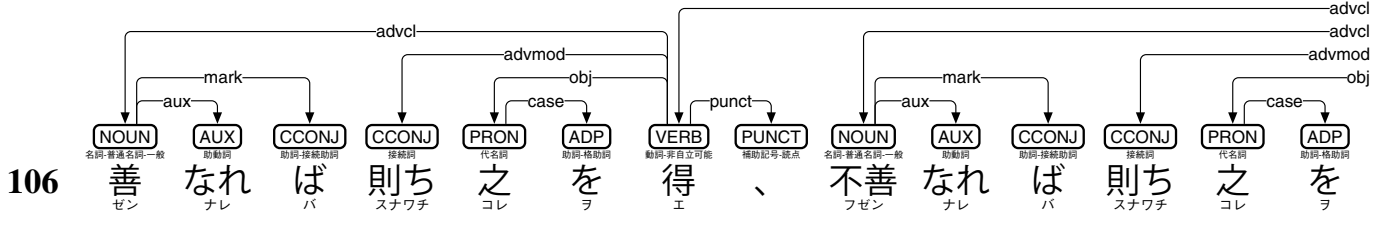
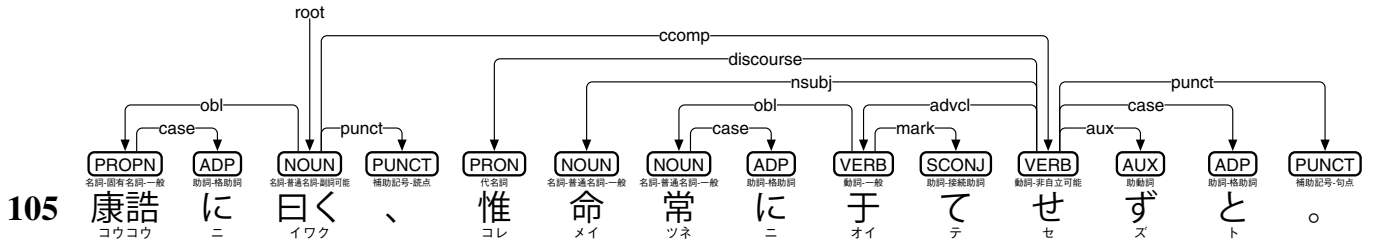

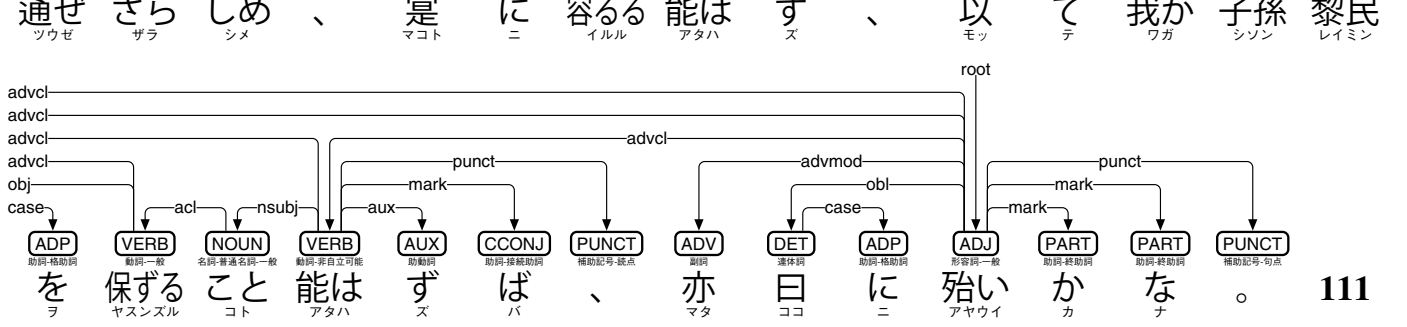
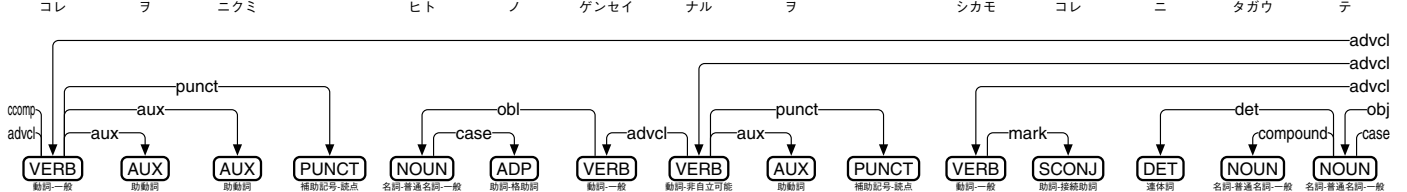
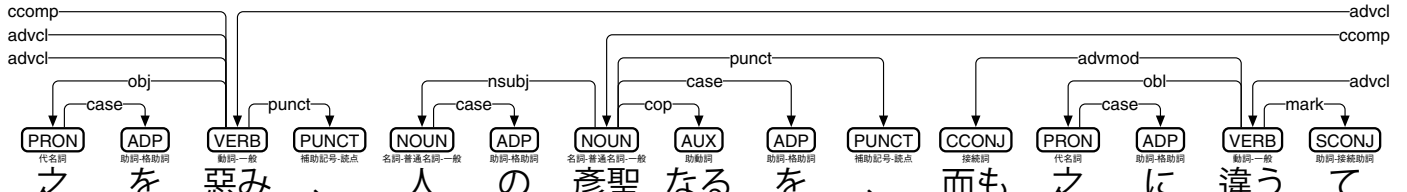
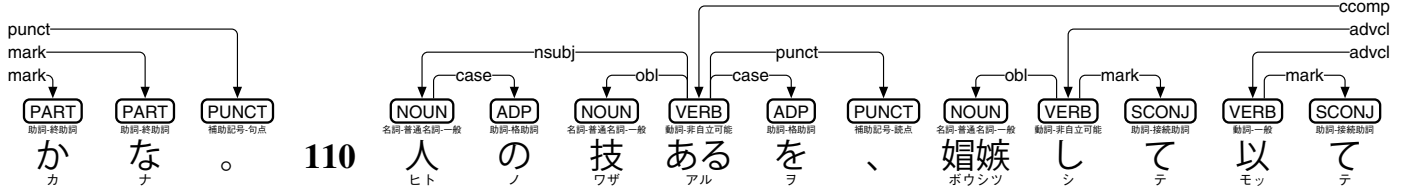
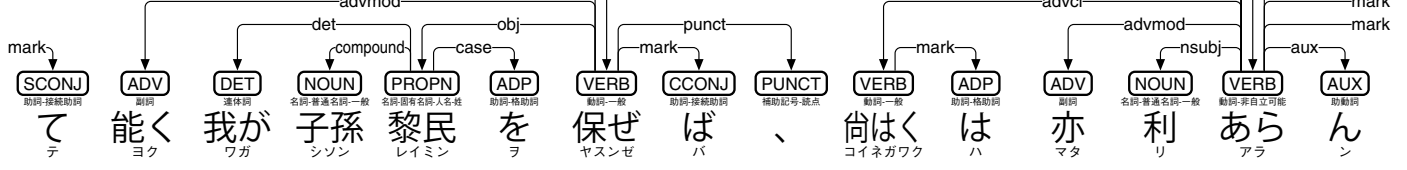
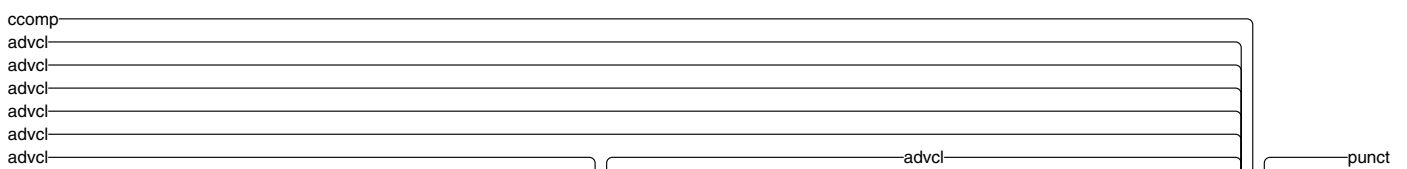
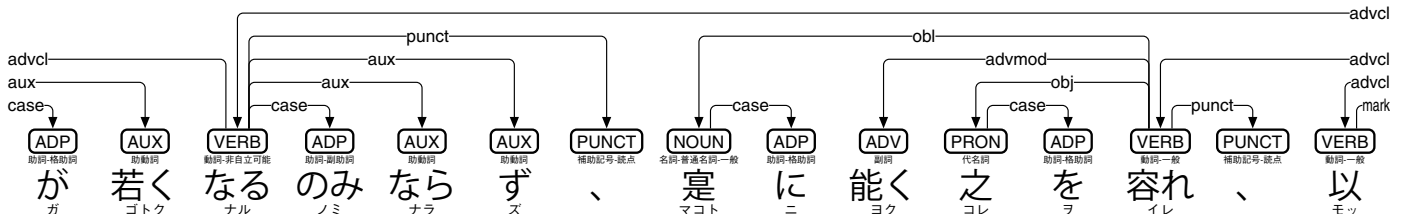
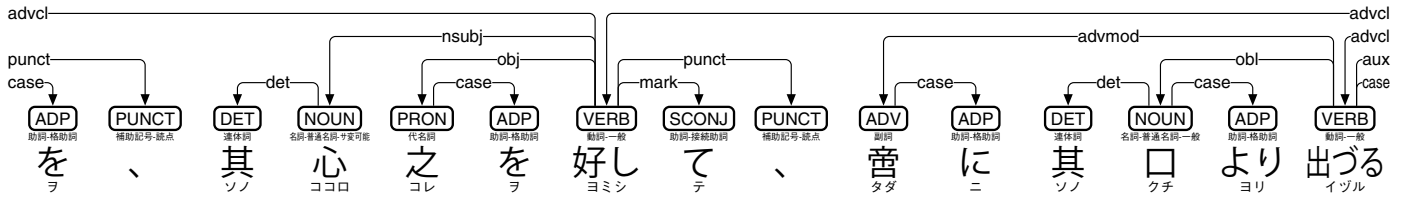
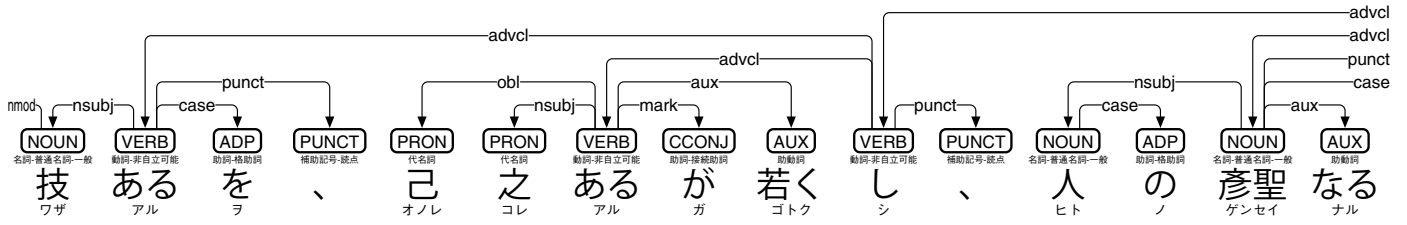

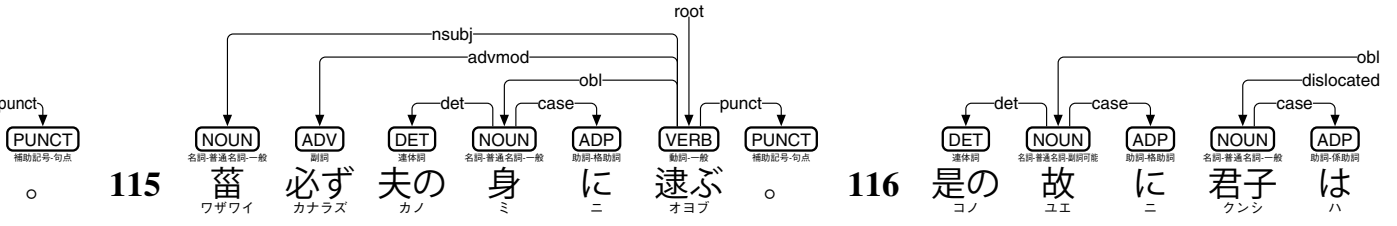
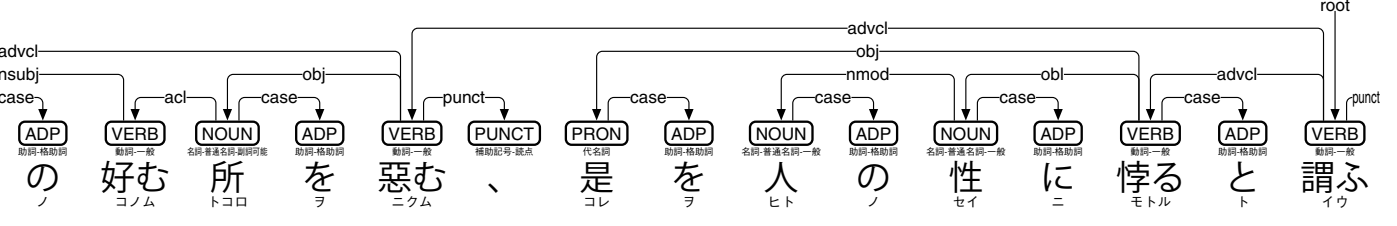
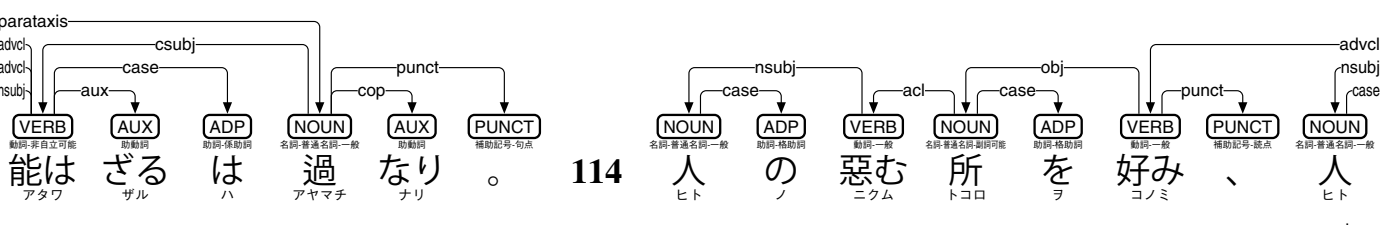
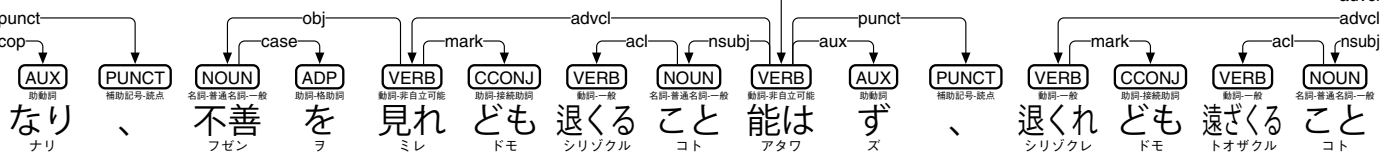
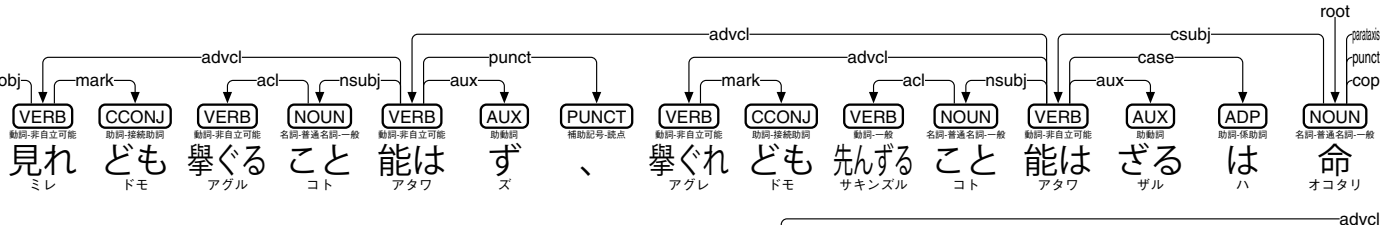
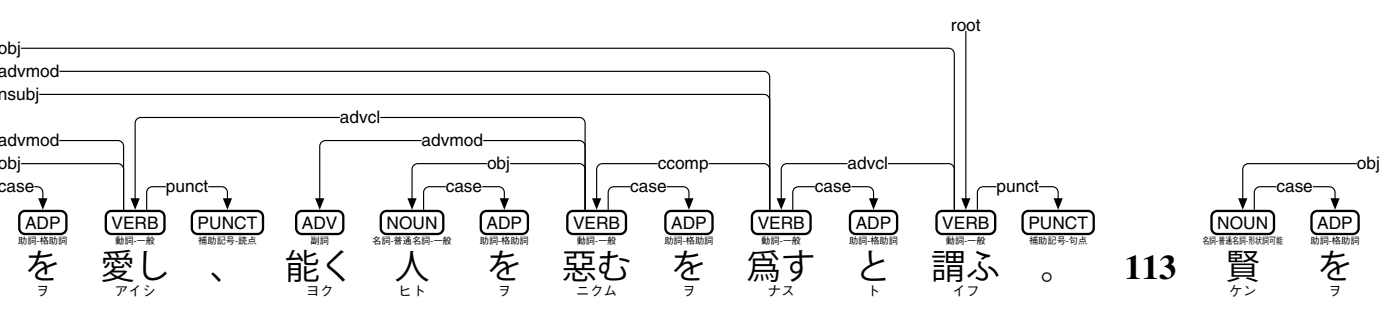
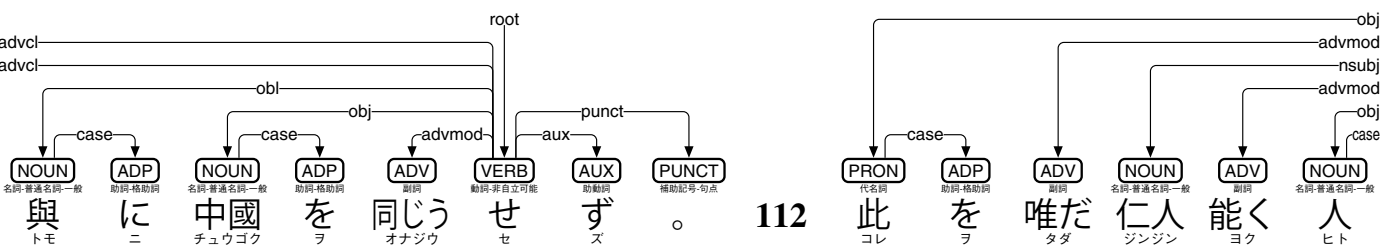
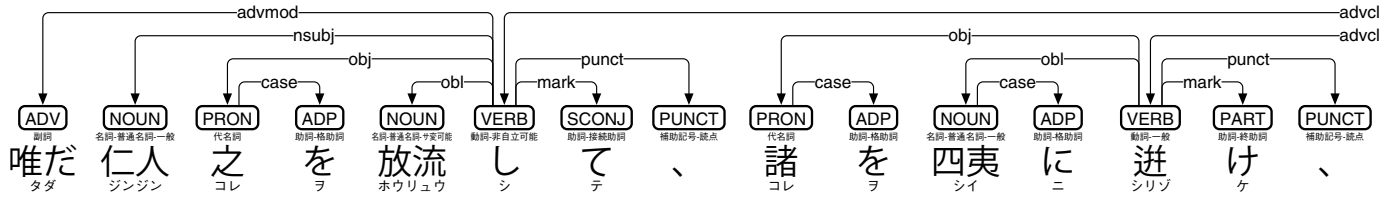

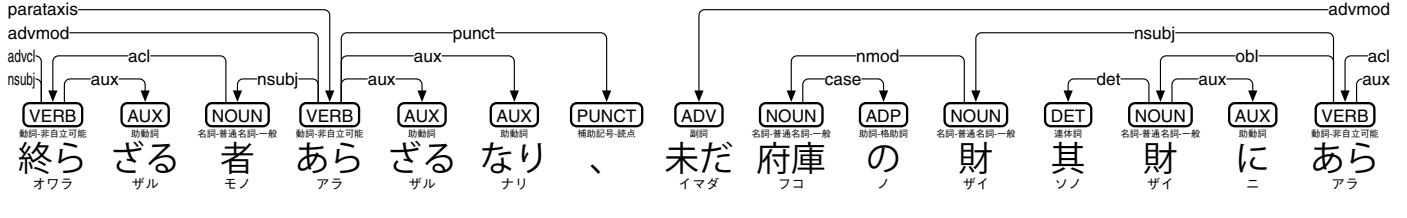
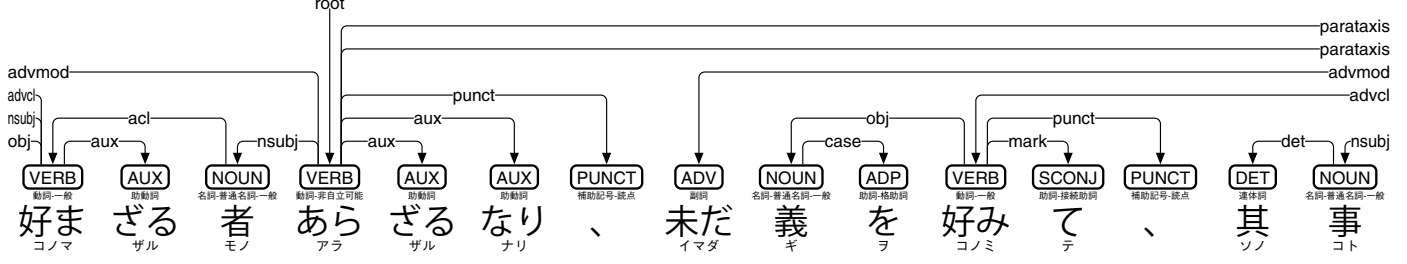
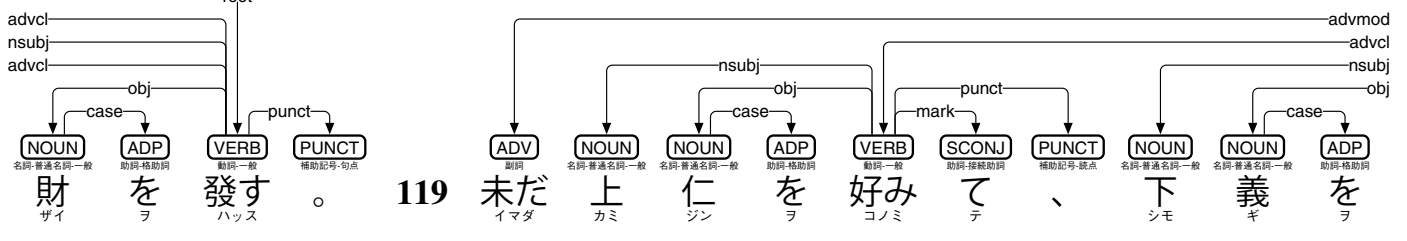
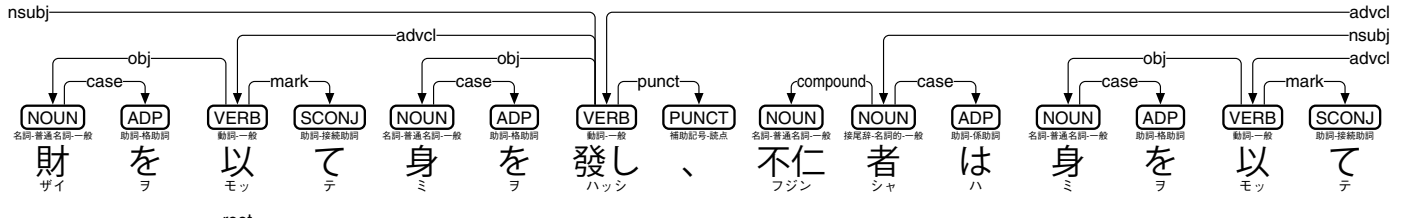
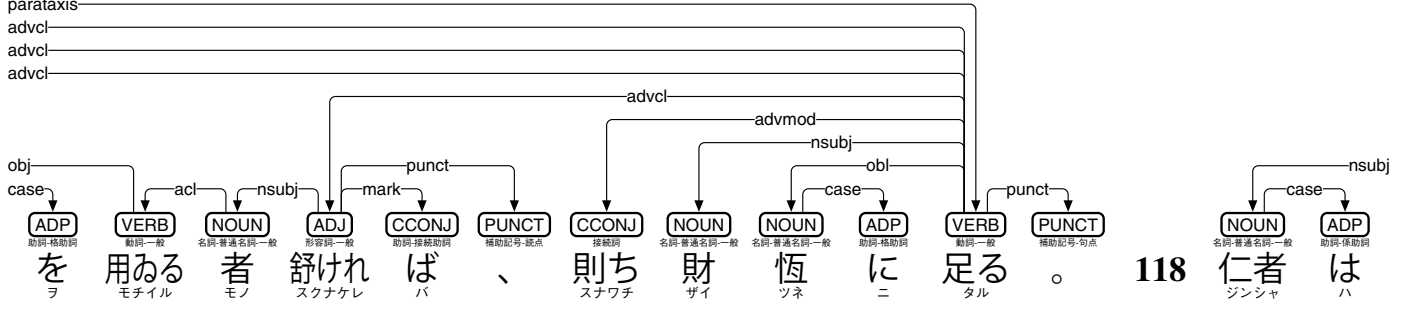
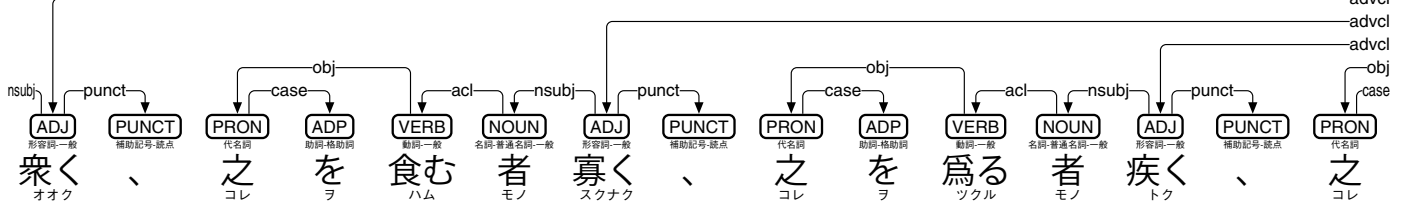
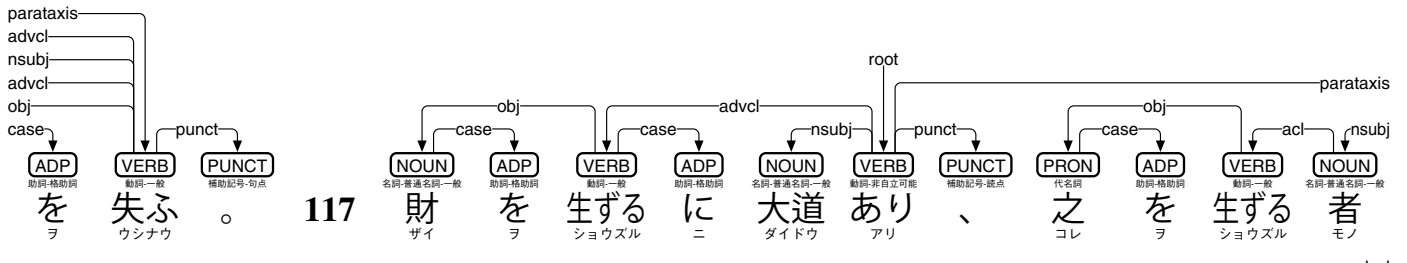
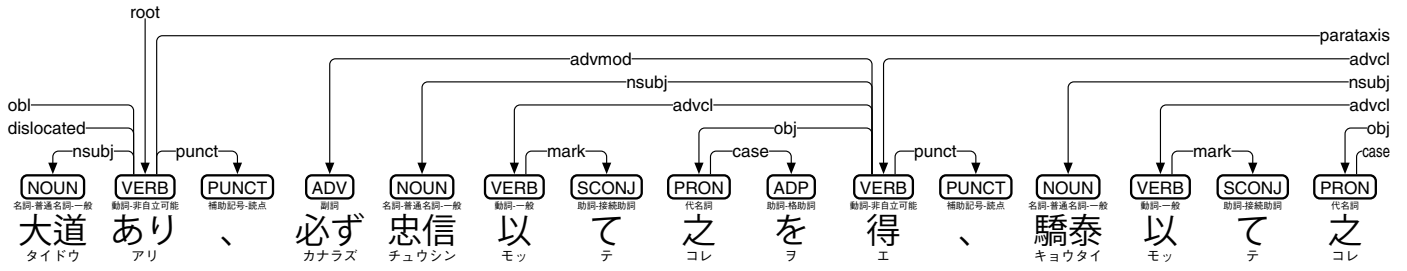

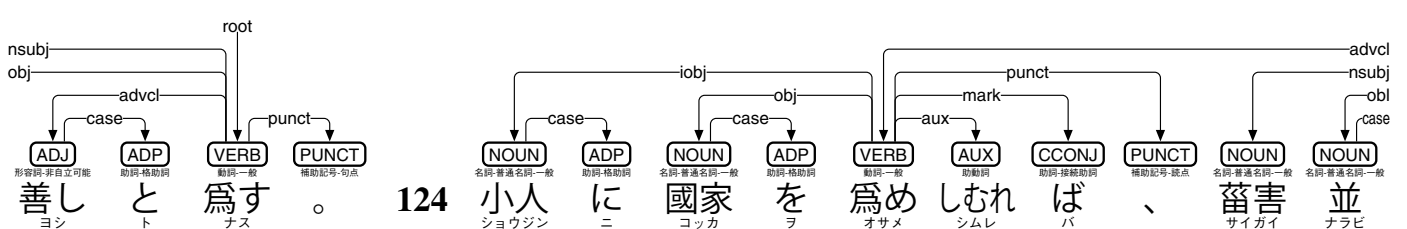
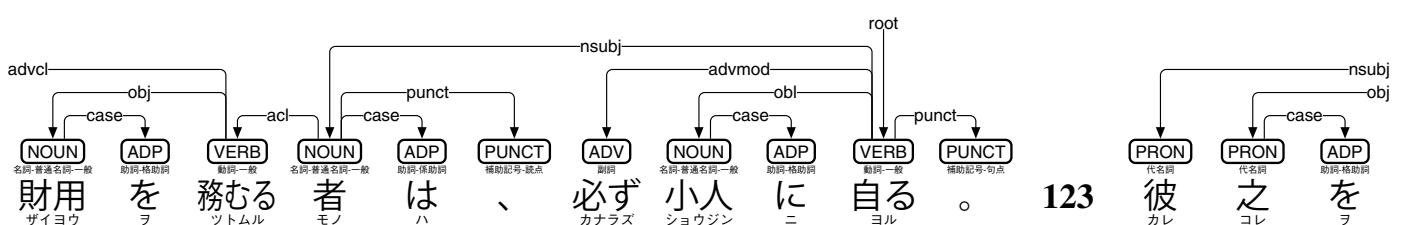
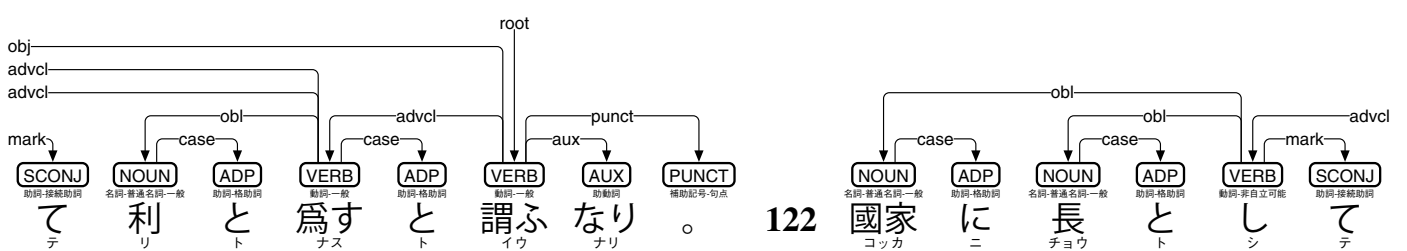
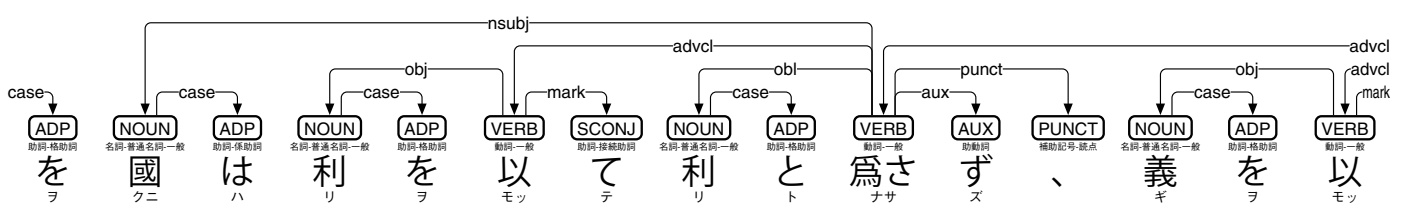
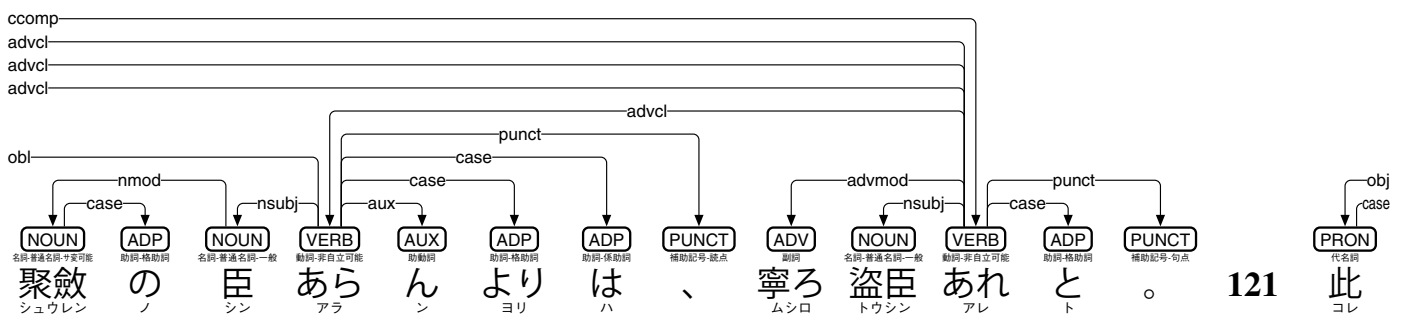
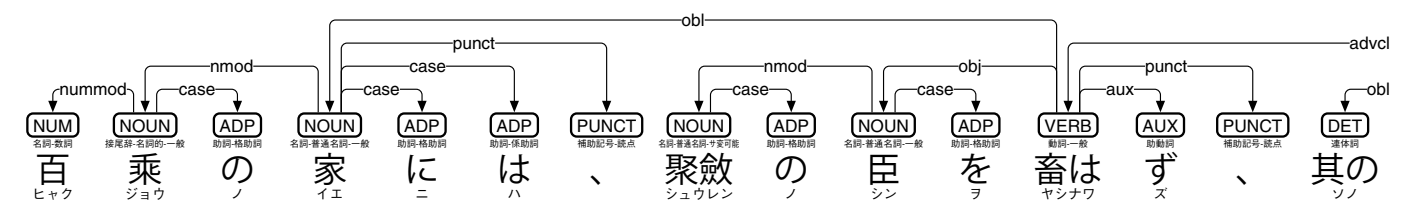
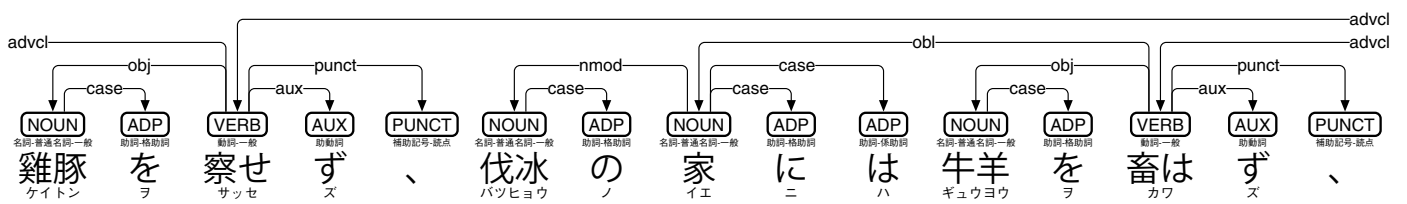
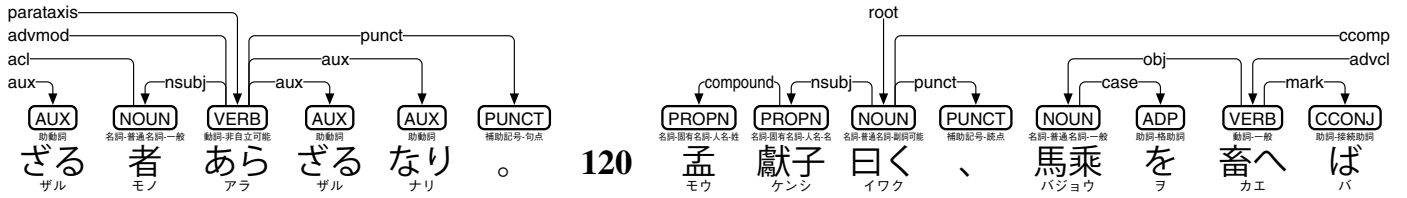

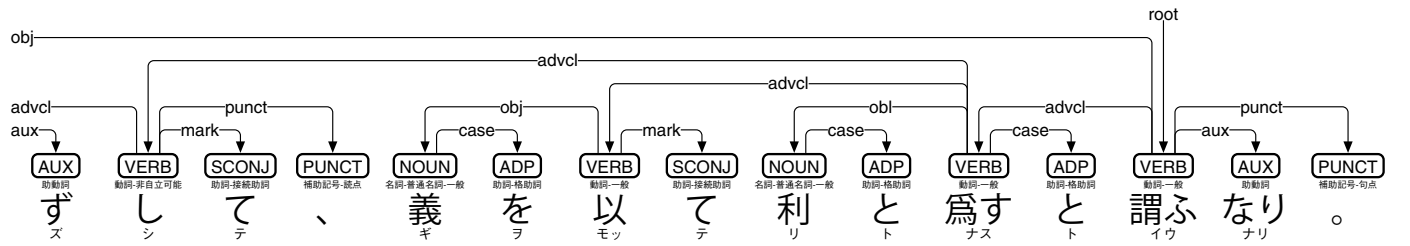
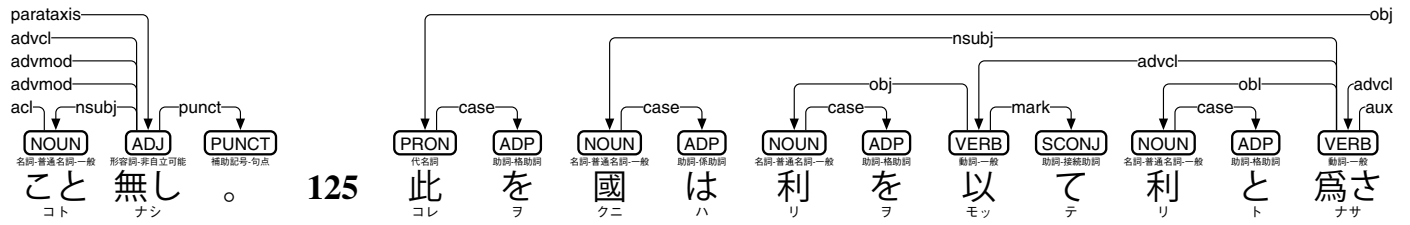
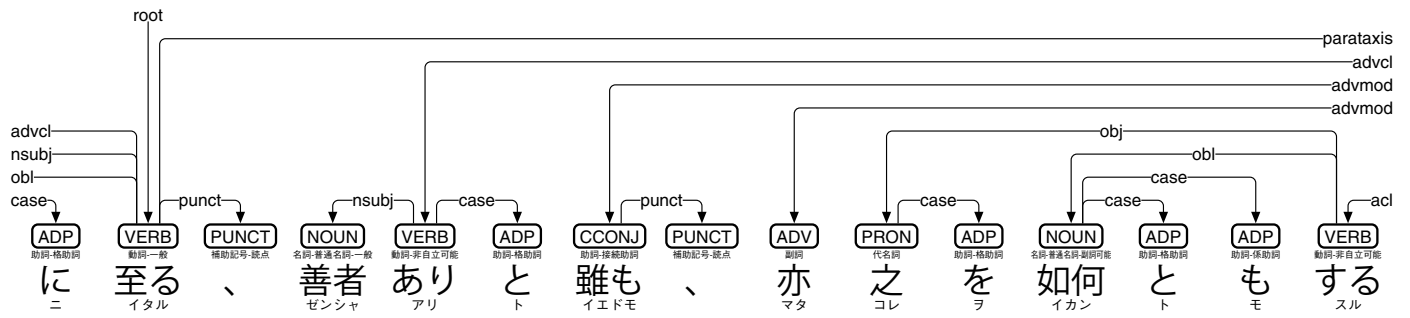

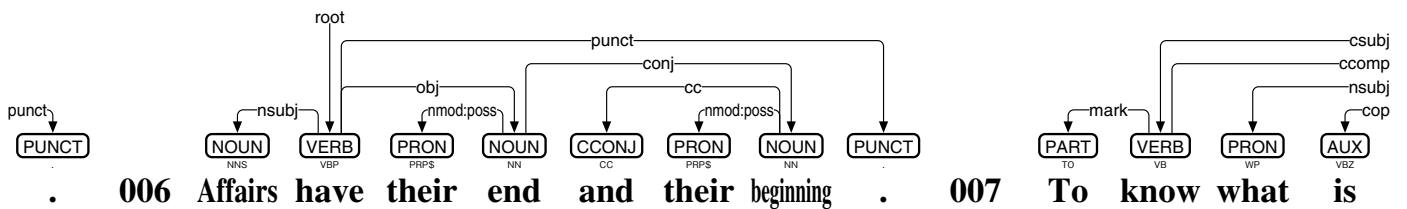
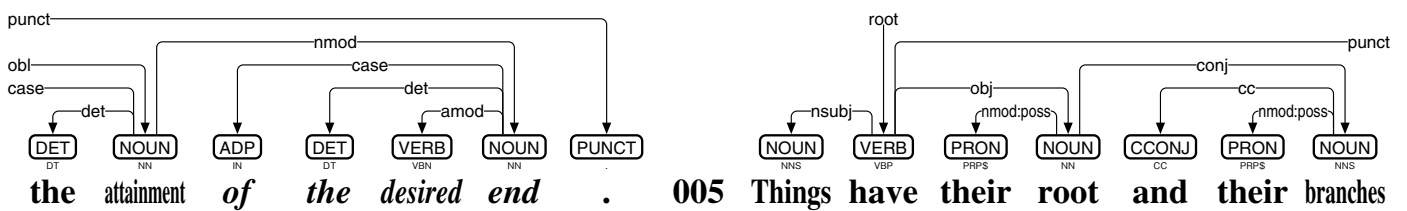
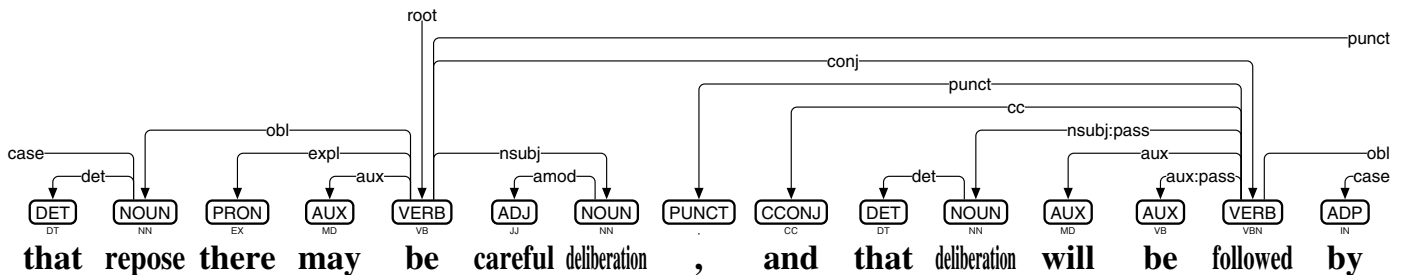
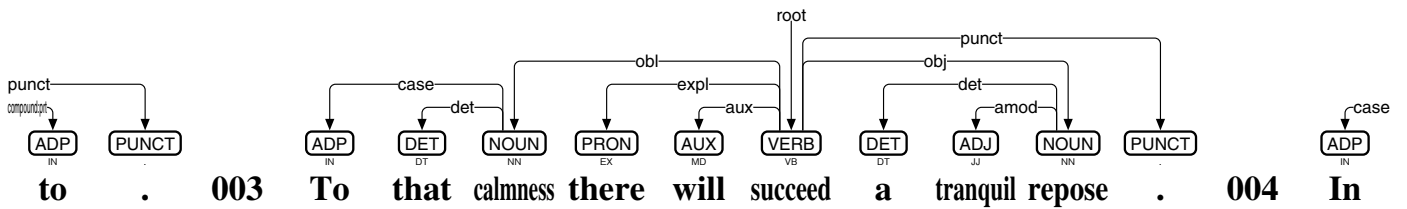
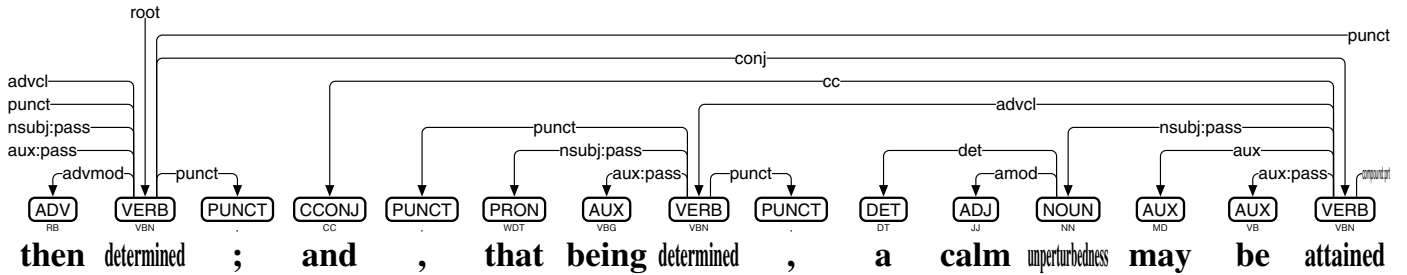
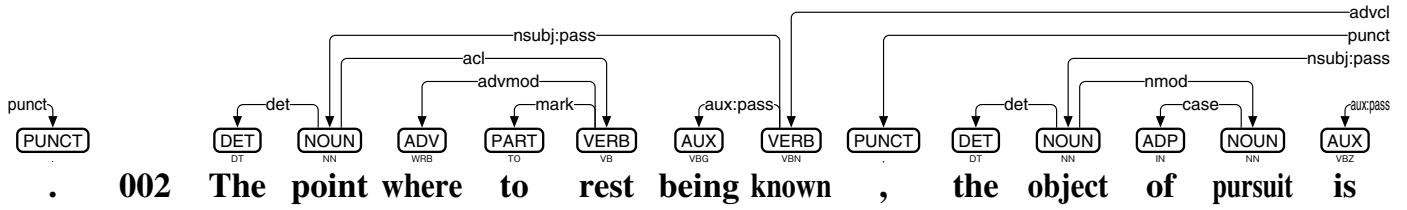
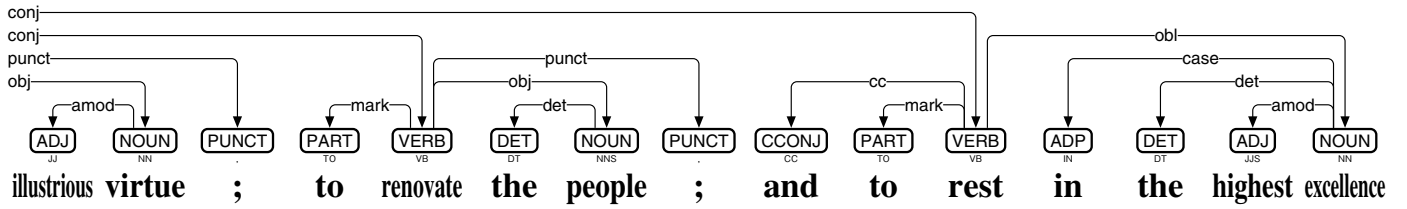
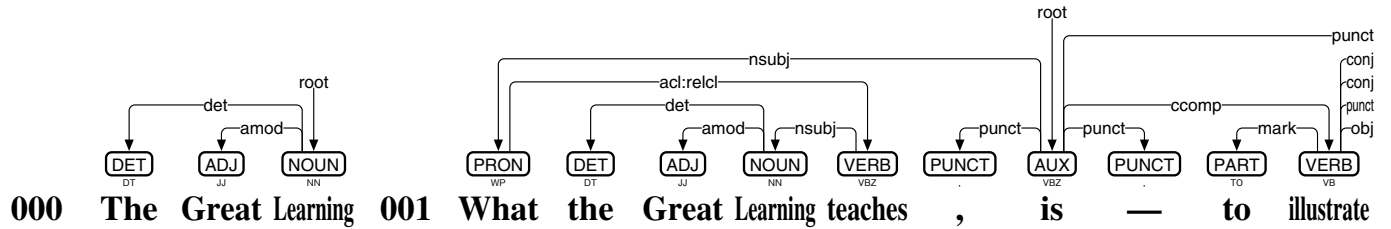

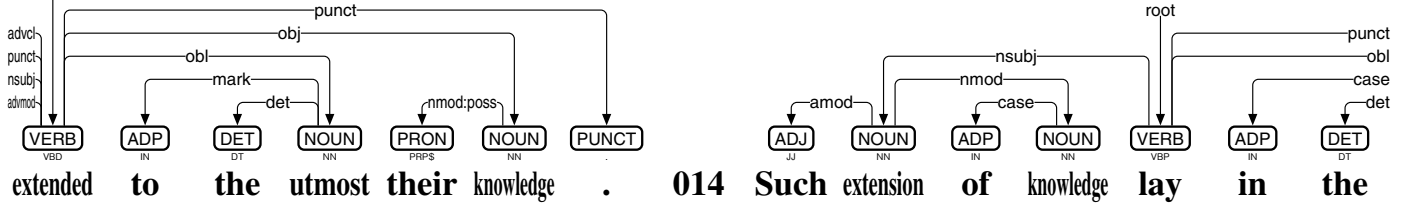
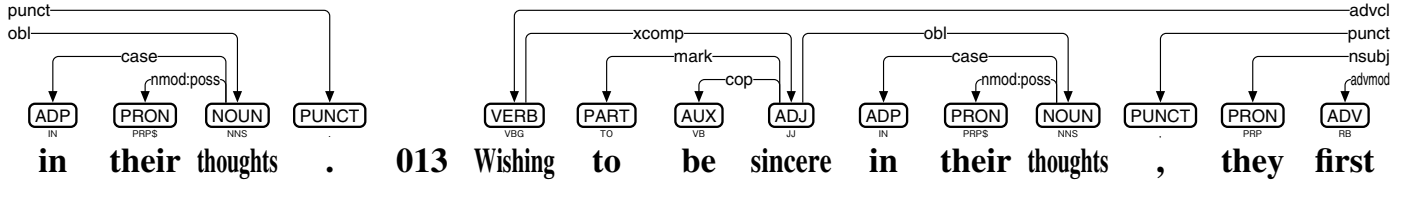
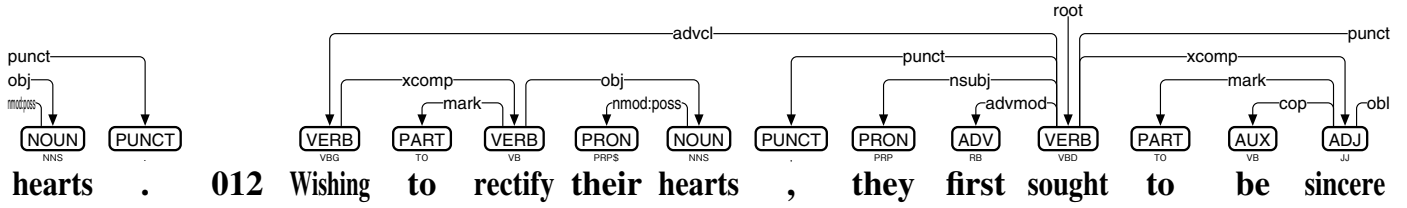
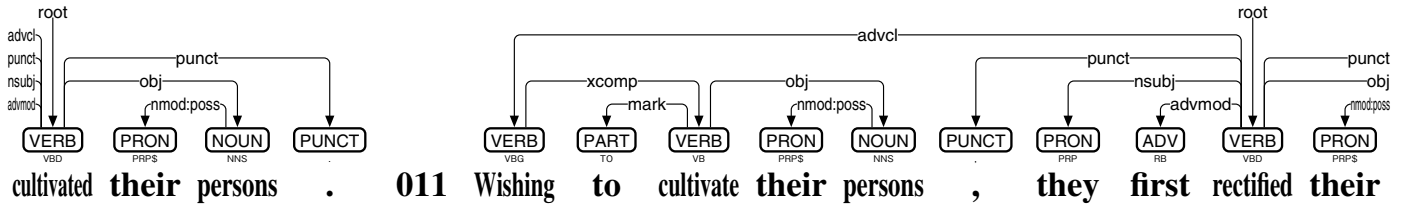
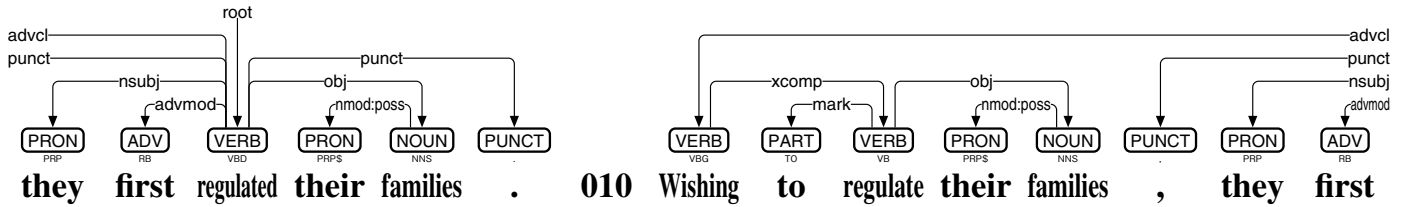
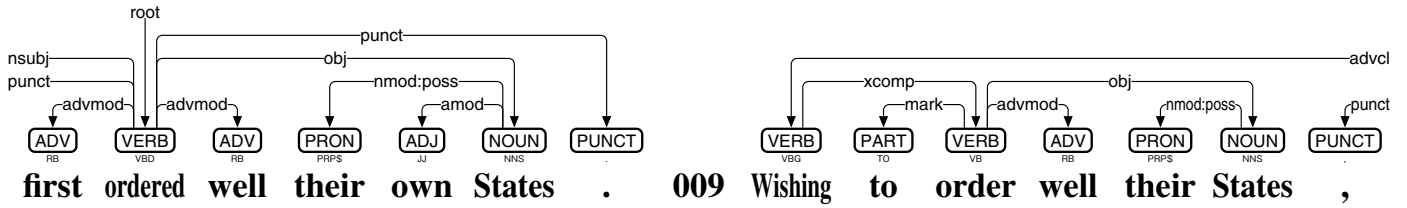
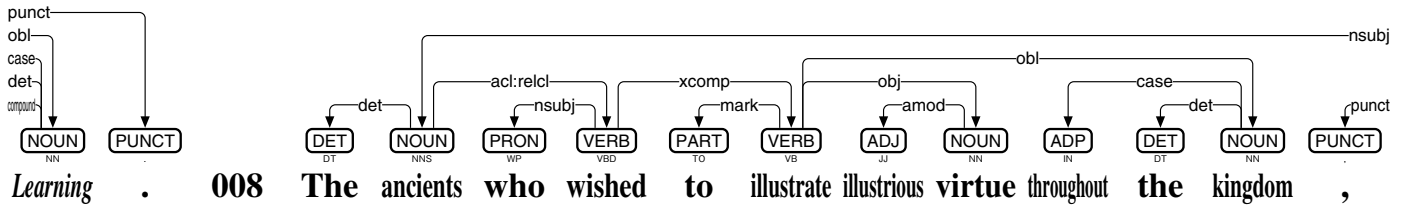
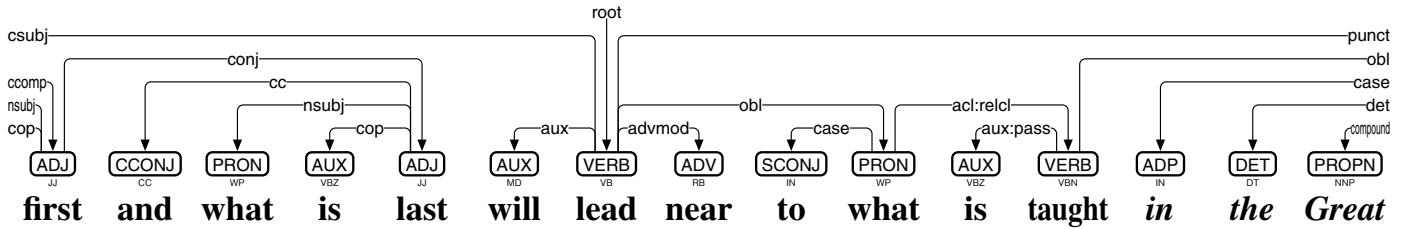

investigation of things . 015 Things being investigated , knowledge became complete . 016 Their

knowledge being complete , their thoughts were sincere . 017 Their thoughts being sincere ,

their hearts were then rectified . 018 Their hearts being rectified , their persons were

cultivated . 019 Their persons being cultivated , their families were regulated . 020 Their

families being regulated , their States were rightly governed . 021 Their States being rightly

governed , the whole kingdom was made tranquil and happy . 022 From the Son

of Heaven down to the mass of the people , all must consider the cultivation

of the person the root of everything besides . 023 It can not be ,

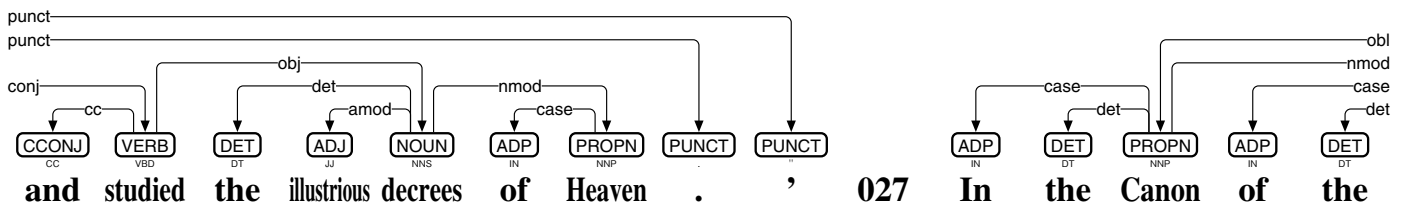
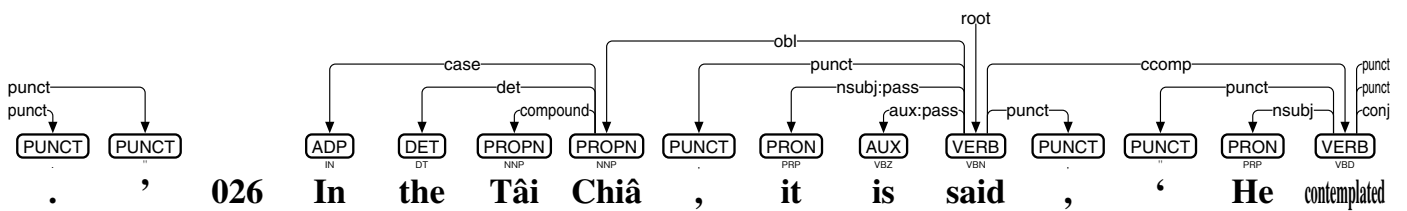
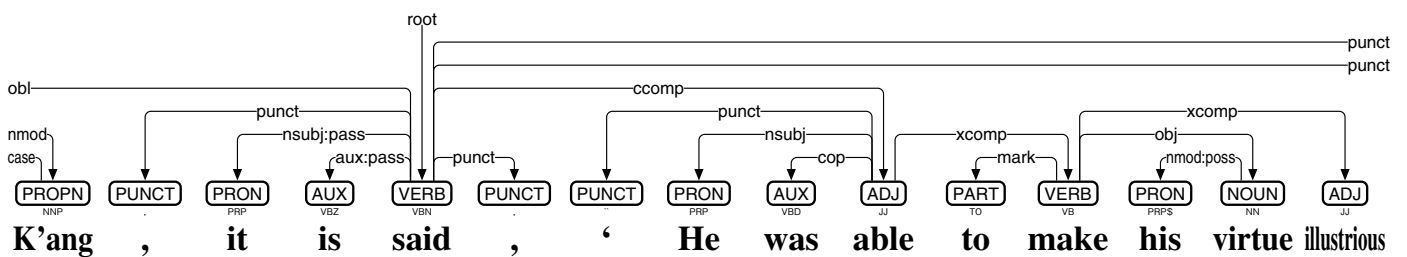
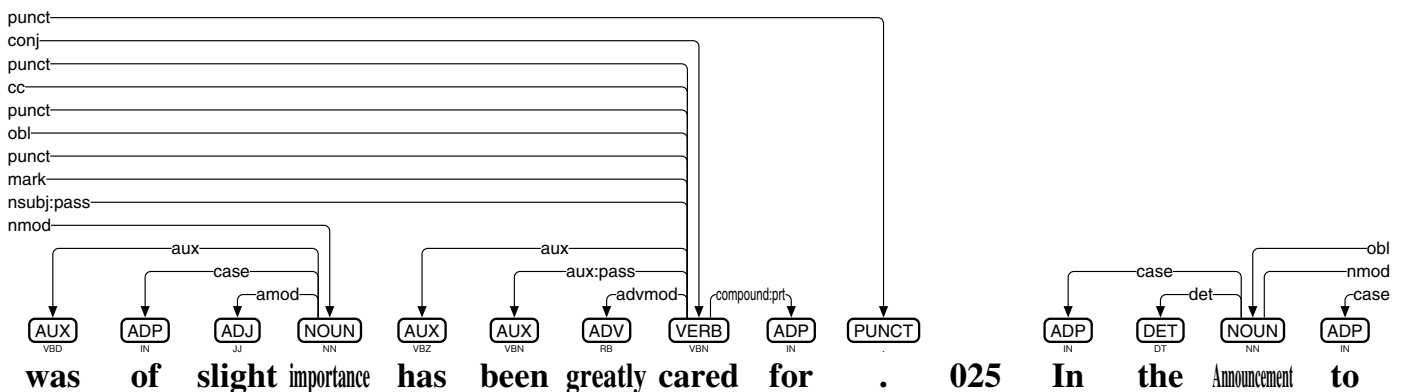
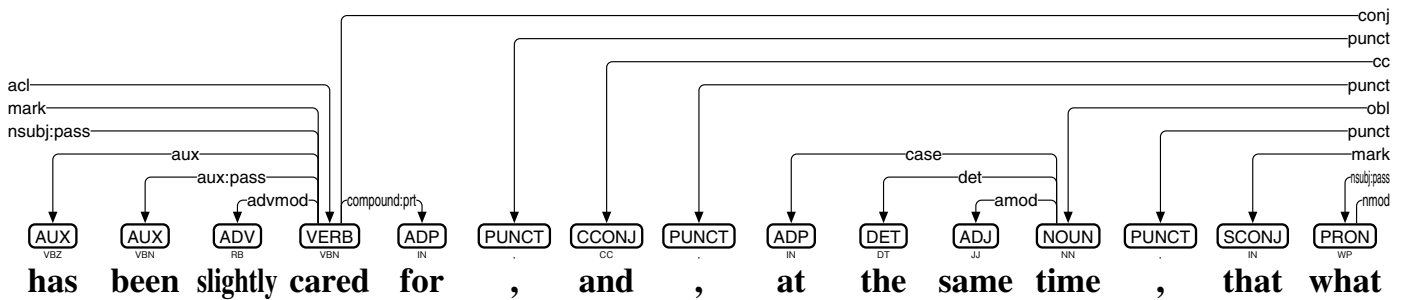
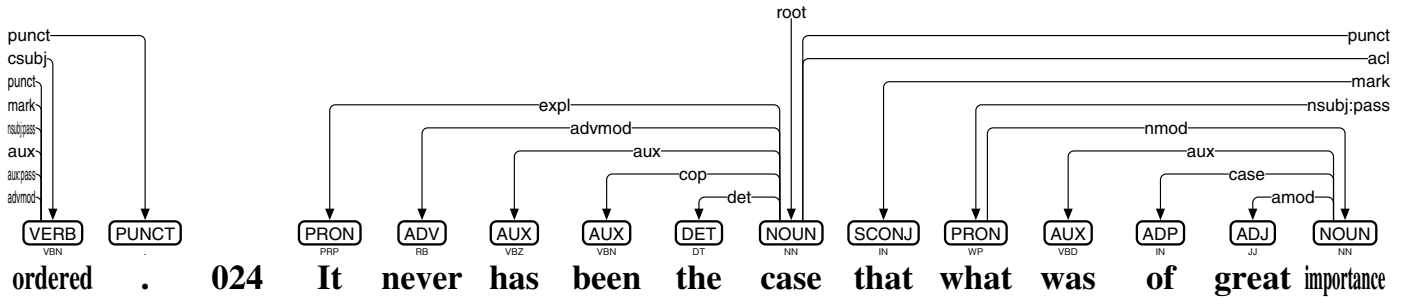
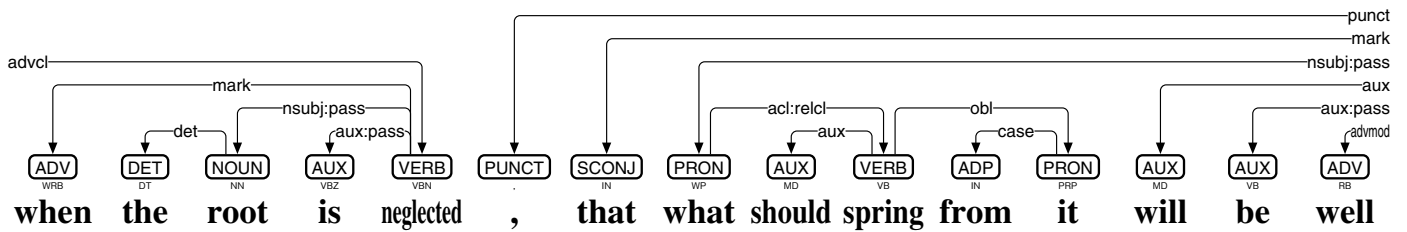

emperor (Yáo) , it is said , ‘ He was able to make

A syntactic tree diagram for the sentence "emperor (Yáo) , it is said , ‘ He was able to make". The root node is "root". It branches into "obl" (emperor), "punct" (comma), "nsubj:pass" (it), "aux:pass" (is), "VERB" (said), "punct" (comma), "ccomp" (‘), "punct" (comma), "nsubj" (He), "aux" (was), "ADJ" (able), "xcomp" (to), "part" (make), and "punct" (period). Further sub-trees show the internal structure of these phrases, such as "emperor" being a noun phrase with "Yáo" as an appositive.

illustrious his lofty virtue . , 028 These passages all show how those sovereigns made

A syntactic tree diagram for the sentence "illustrious his lofty virtue . , 028 These passages all show how those sovereigns made". The root node is "root". It branches into "punct" (period), "xcomp" (illustrious), "nmod:poss" (his), "amod" (lofty), "NOUN" (virtue), "punct" (period), "punct" (comma), "DET" (028), "NOUN" (These), "punct" (comma), "DET" (all), "VERB" (show), "ADV" (how), "DET" (those), "NOUN" (sovereigns), and "VERB" (made). Sub-trees show the structure of "illustrious his lofty virtue" as a noun phrase and "These passages" as a noun phrase.

themselves illustrious . 029 On the bathing - tub of T'ang , the following words

A syntactic tree diagram for the sentence "themselves illustrious . 029 On the bathing - tub of T'ang , the following words". The root node is "root". It branches into "punct" (period), "xcomp" (themselves), "ADJ" (illustrious), "punct" (period), "ADP" (On), "DET" (the), "NOUN" (bathing), "punct" (hyphen), "NOUN" (tub), "ADP" (of), "PROPN" (T'ang), "punct" (comma), "DET" (the), "VERB" (following), and "NOUN" (words). Sub-trees show the structure of "On the bathing - tub of T'ang" as a prepositional phrase and "the following words" as a noun phrase.

were engraved : — 030 ‘ If you can one day renovate yourself , do

A syntactic tree diagram for the sentence "were engraved : — 030 ‘ If you can one day renovate yourself , do". The root node is "root". It branches into "obl" (were), "punct" (colon), "aux:pass" (engraved), "punct" (dash), "punct" (030), "punct" (comma), "mark" (‘), "nsubj" (If), "aux" (you), "nummod" (can), "NOUN" (one), "NOUN" (day), "VERB" (renovate), "obl" (yourself), "punct" (comma), "advcl" (do), and "punct" (period). Sub-trees show the structure of "If you can one day renovate yourself" as a conditional clause and "do" as an imperative.

so from day to day . 031 Yea , let there be daily renovation .

A syntactic tree diagram for the sentence "so from day to day . 031 Yea , let there be daily renovation .". The root node is "root". It branches into "punct" (period), "adv" (so), "ADP" (from), "NOUN" (day), "ADP" (to), "NOUN" (day), "punct" (period), "punct" (031), "punct" (comma), "INTJ" (Yea), "punct" (comma), "VERB" (let), "discourse" (there), "punct" (comma), "PRON" (be), "ADJ" (daily), "NOUN" (renovation), and "punct" (period). Sub-trees show the structure of "so from day to day" as an adverbial phrase and "let there be daily renovation" as a clause.

, 032 In the Announcement to K'ang , it is said , ‘ To stir

A syntactic tree diagram for the sentence ", 032 In the Announcement to K'ang , it is said , ‘ To stir". The root node is "root". It branches into "punct" (comma), "ADP" (In), "DET" (the), "NOUN" (Announcement), "ADP" (to), "PROPN" (K'ang), "punct" (comma), "PRON" (it), "aux:pass" (is), "VERB" (said), "punct" (comma), "punct" (‘), "PART" (To), "mark" (stir), and "punct" (period). Sub-trees show the structure of "In the Announcement to K'ang" as a prepositional phrase and "it is said" as a clause.

up the new people . , 033 In the Book of Poetry , it is

A syntactic tree diagram for the sentence "up the new people . , 033 In the Book of Poetry , it is". The root node is "root". It branches into "punct" (period), "punct" (comma), "ADP" (up), "DET" (the), "ADJ" (new), "NOUN" (people), "punct" (period), "punct" (comma), "punct" (033), "ADP" (In), "DET" (the), "PROPN" (Book), "ADP" (of), "PROPN" (Poetry), "punct" (comma), "PRON" (it), "aux:pass" (is), and "punct" (period). Sub-trees show the structure of "up the new people" as a noun phrase and "In the Book of Poetry" as a prepositional phrase.

said , ‘ Although Cháu was an ancient State , the ordinance which lighted on

A syntactic tree diagram for the sentence "said , ‘ Although Cháu was an ancient State , the ordinance which lighted on". The root node is "root". It branches into "obl" (said), "punct" (comma), "punct" (‘), "mark" (Although), "nsubj" (Cháu), "cop" (was), "det" (an), "amod" (ancient), "NOUN" (State), "punct" (comma), "punct" (‘), "DET" (the), "NOUN" (ordinance), "punct" (comma), "acl:relcl" (which), "nsubj" (lighted), and "ADP" (on). Sub-trees show the structure of "Although Cháu was an ancient State" as a clause and "the ordinance which lighted on" as a noun phrase.

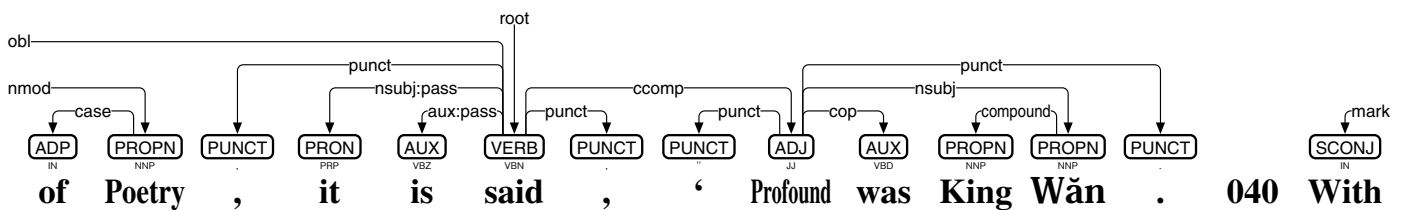
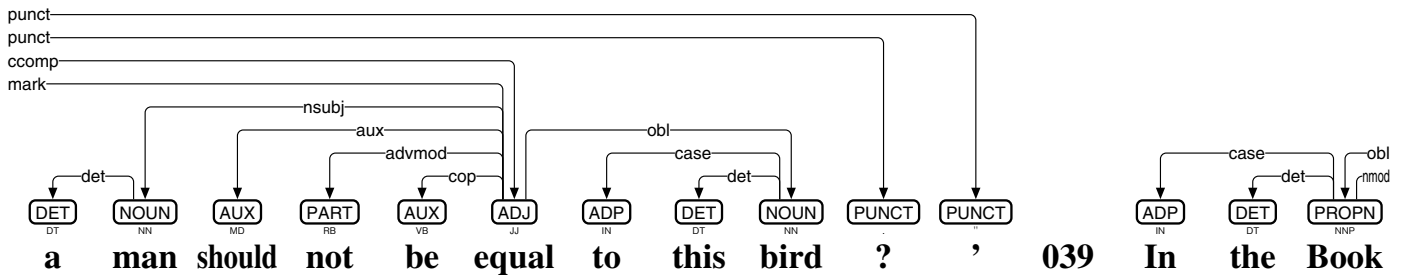
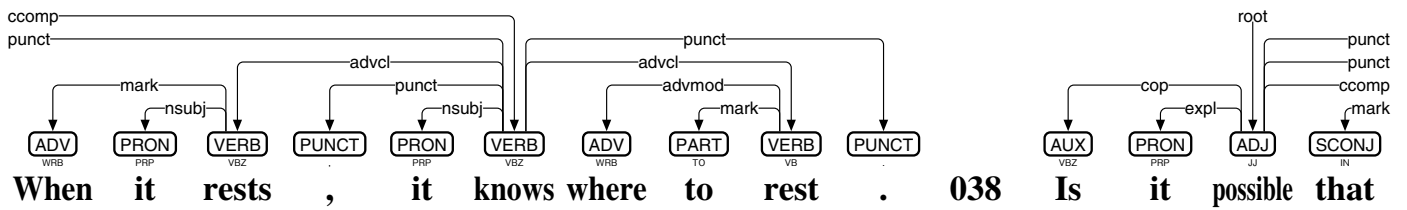
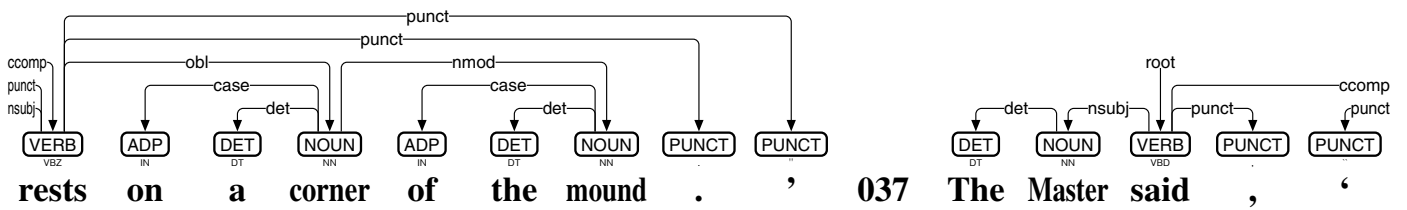
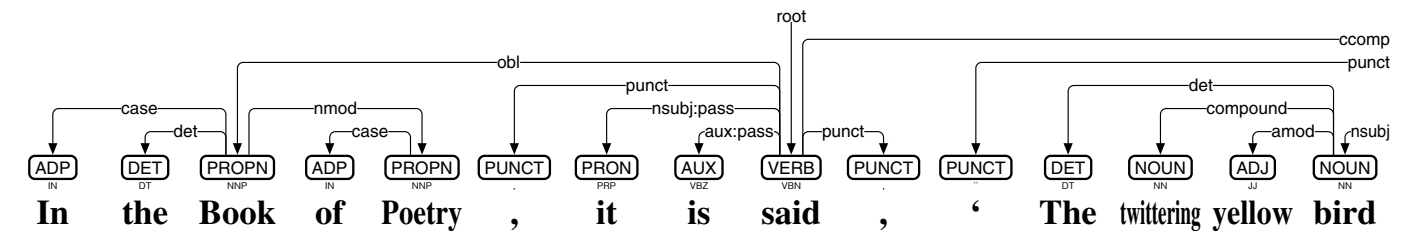
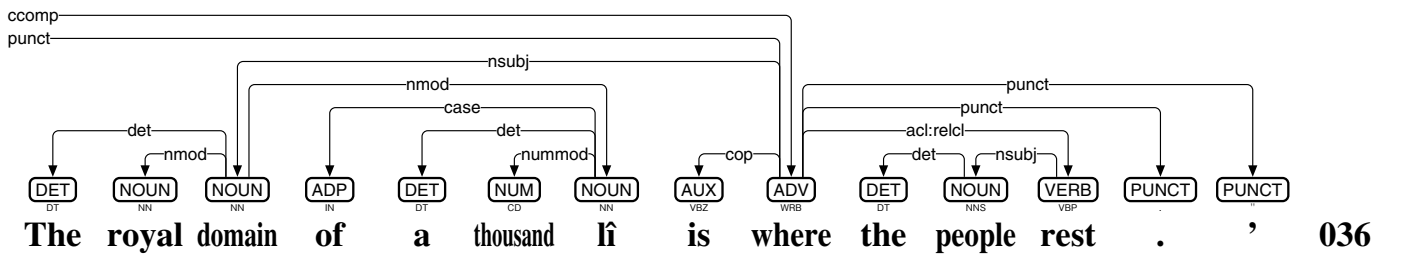
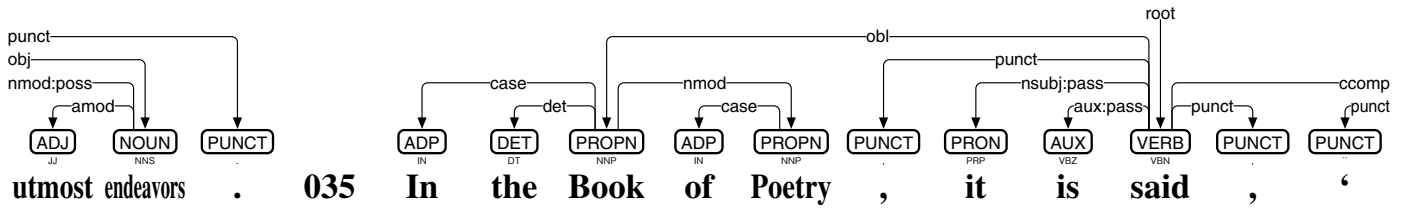
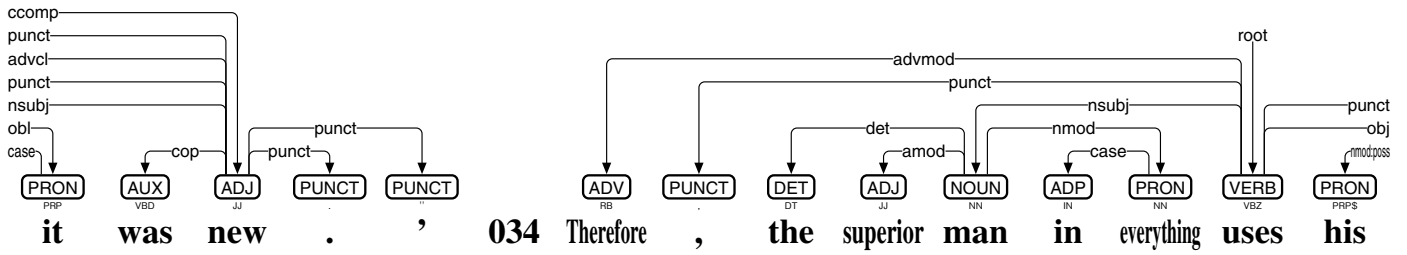

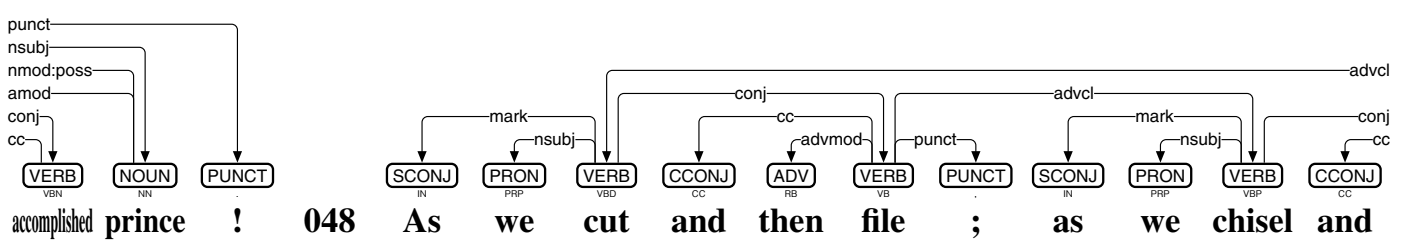
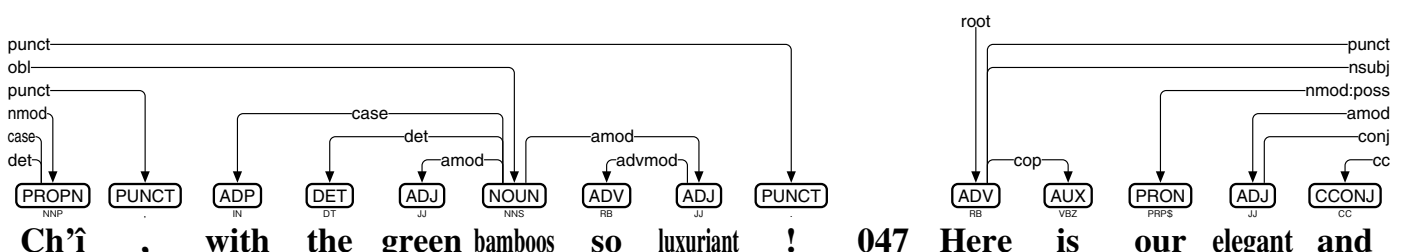
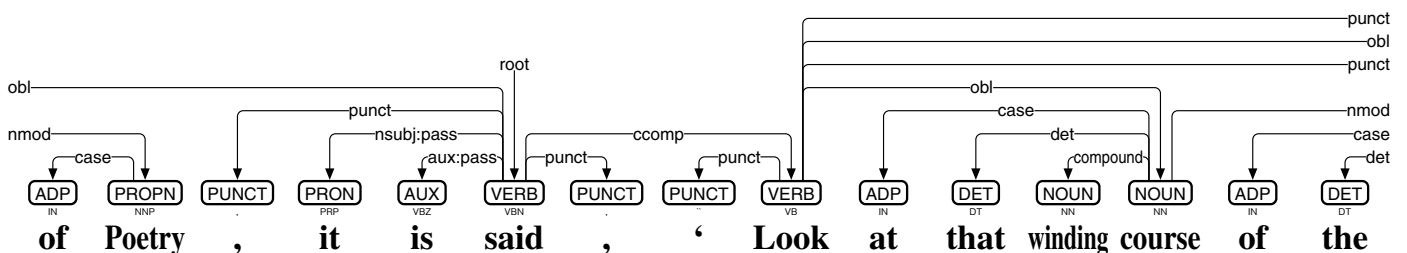
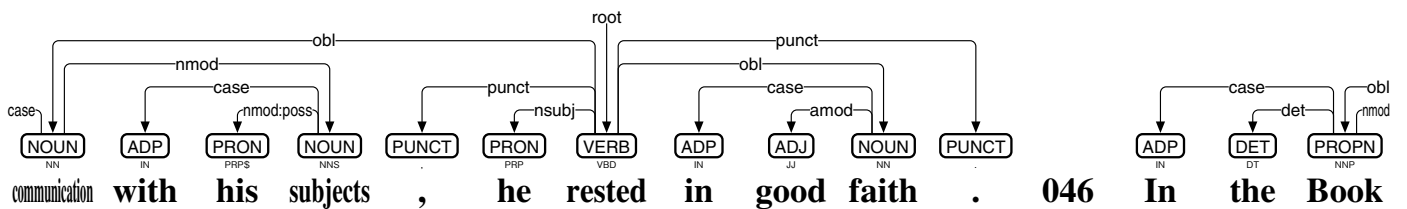
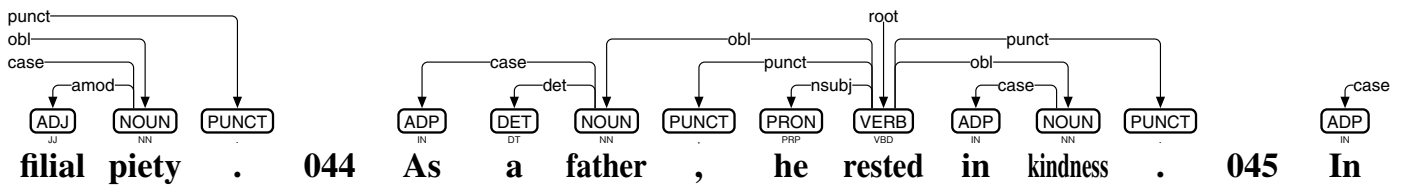
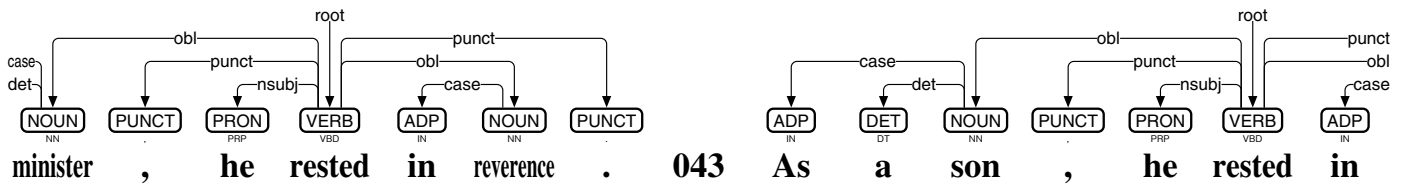
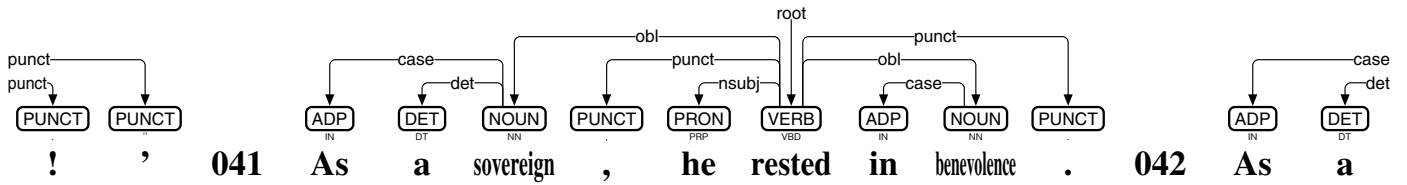
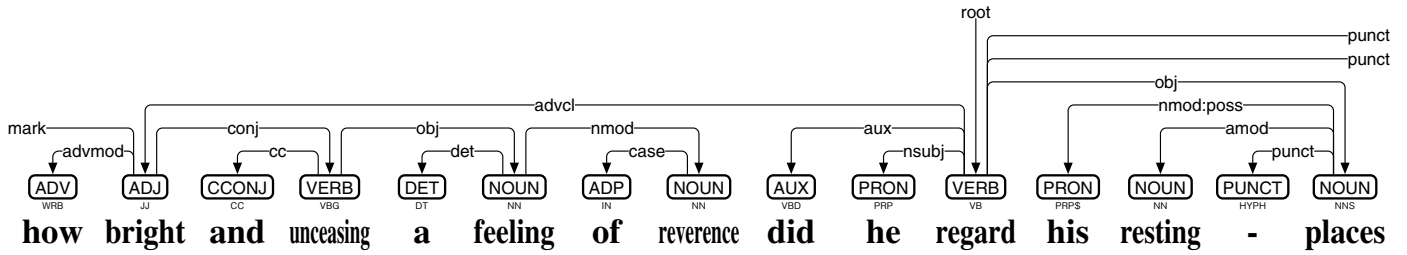

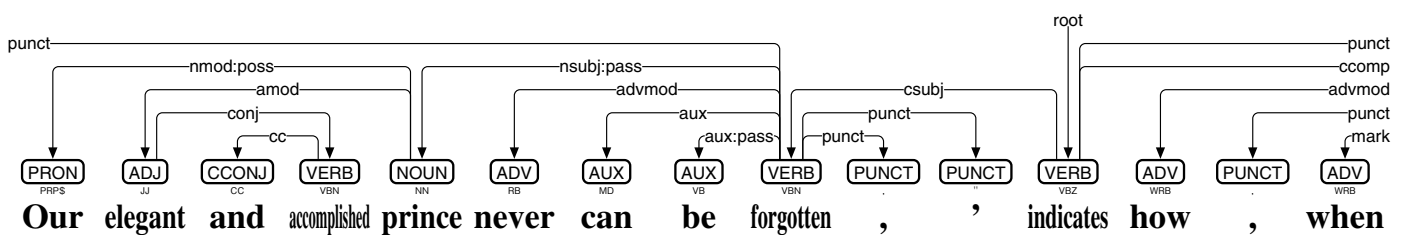
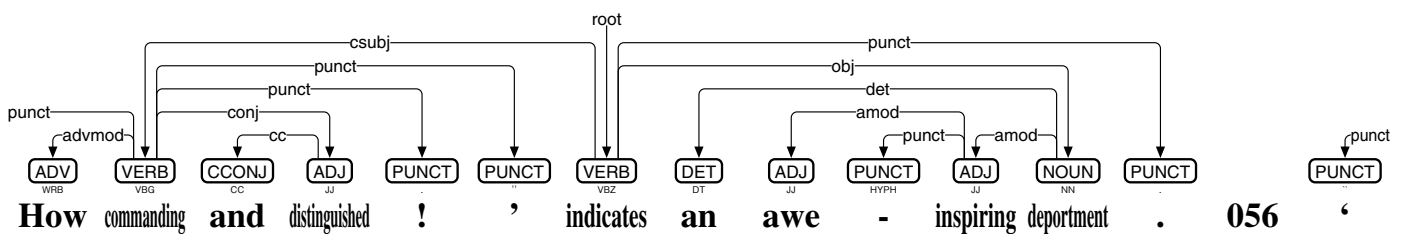
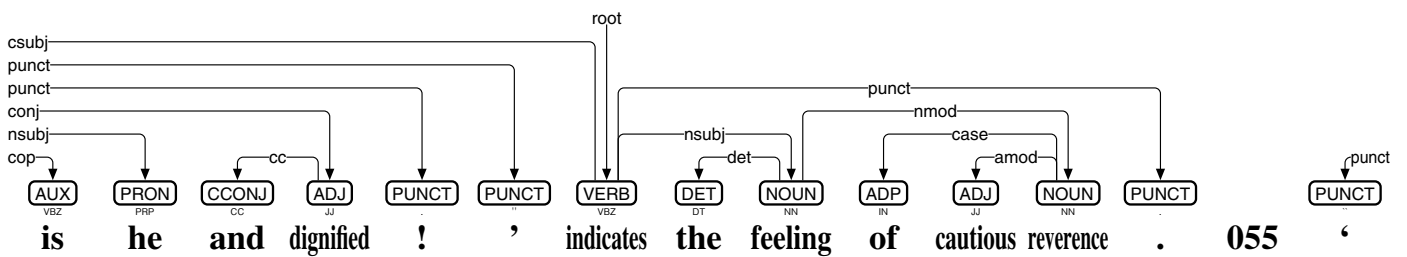
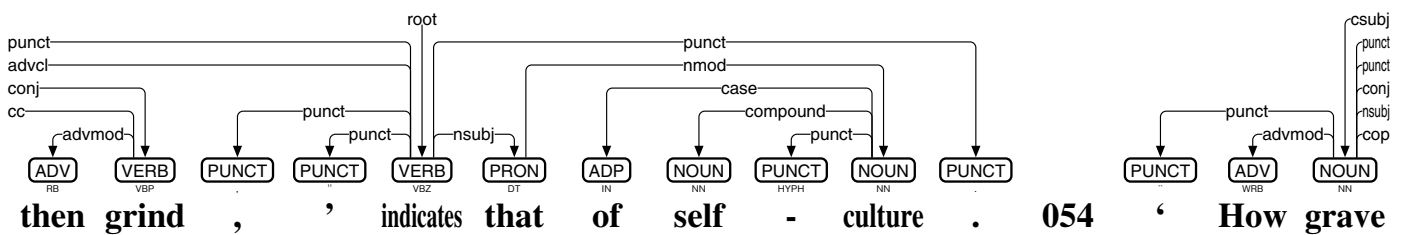
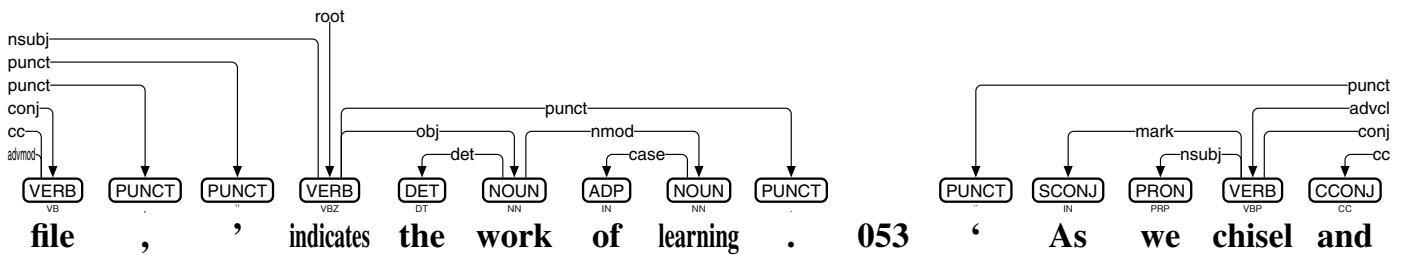
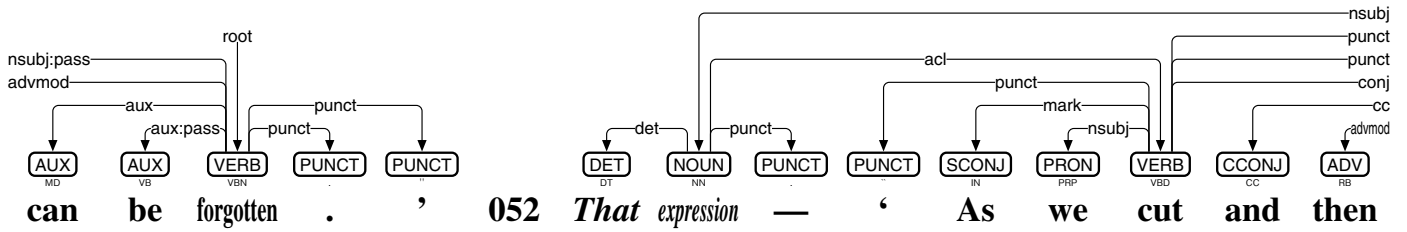
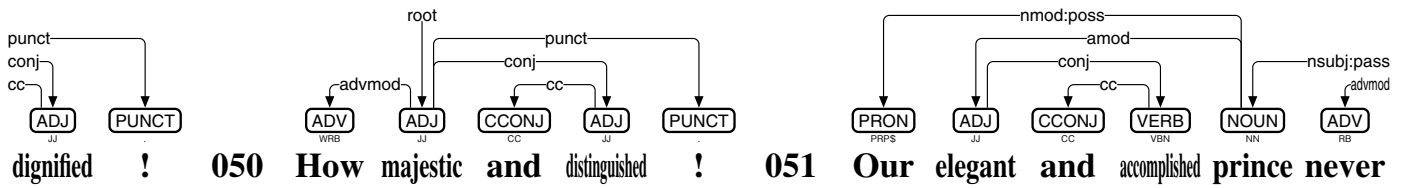
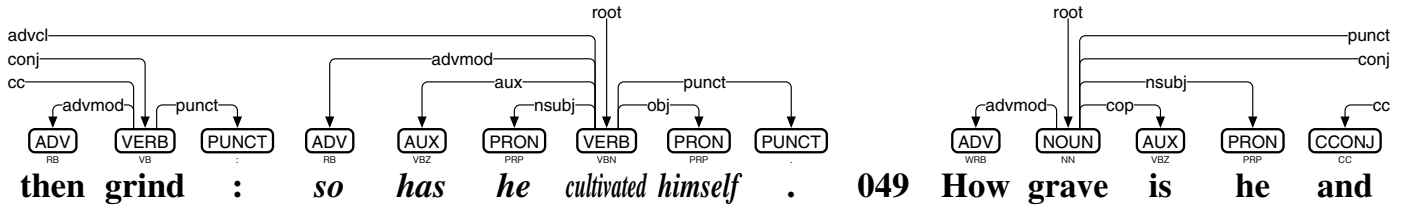

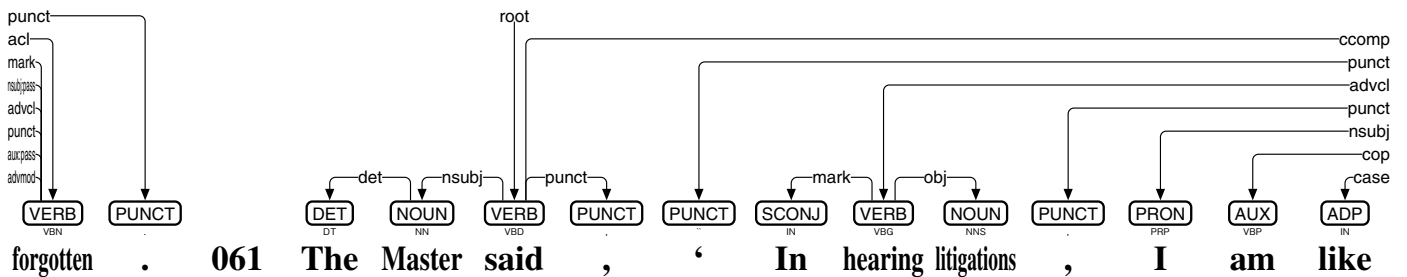
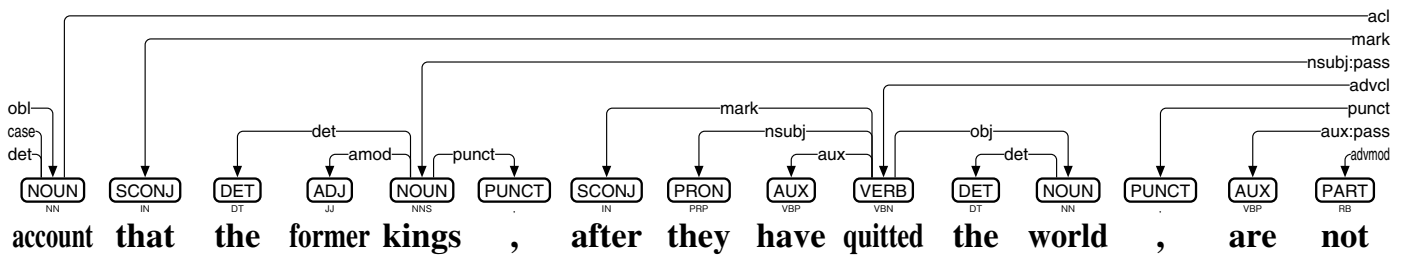
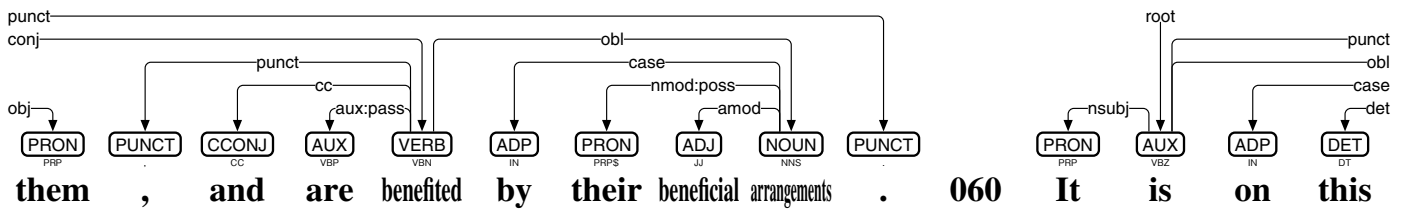
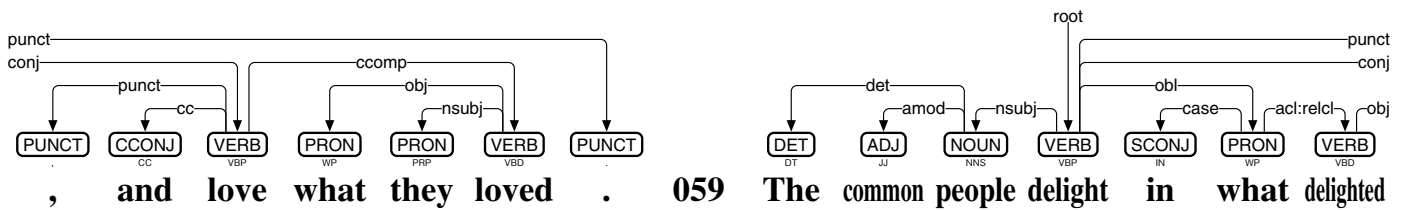
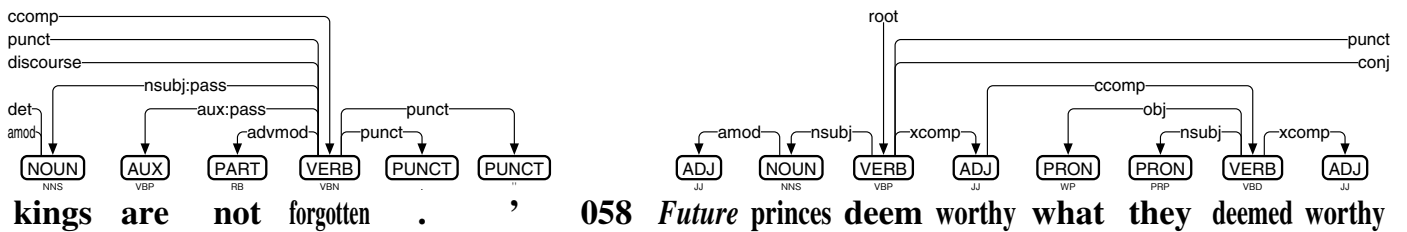
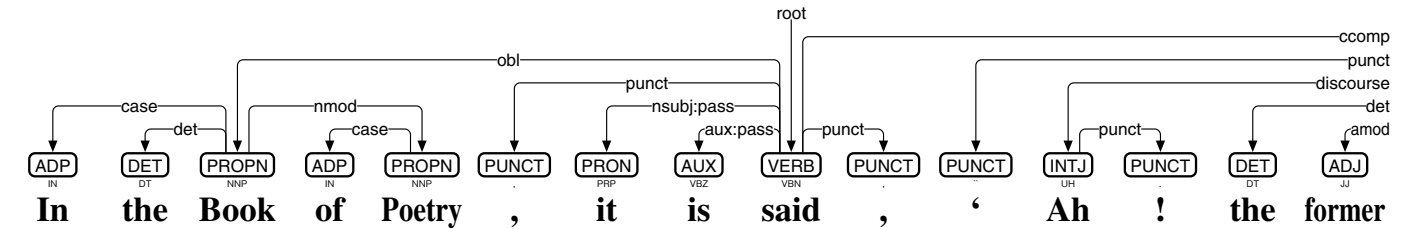
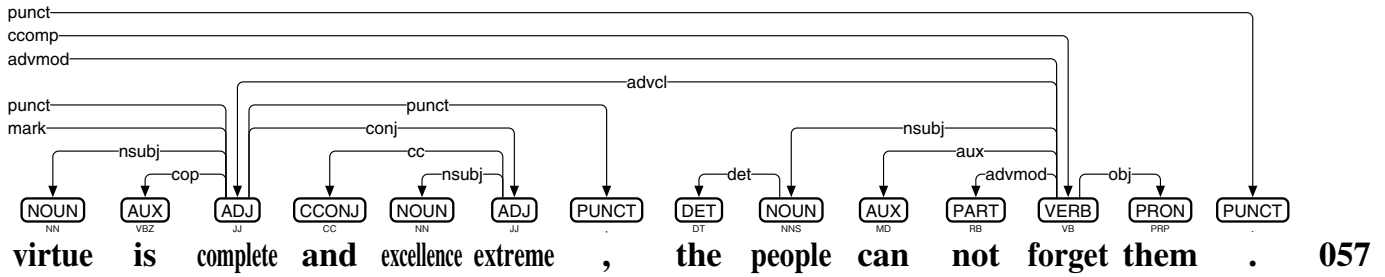

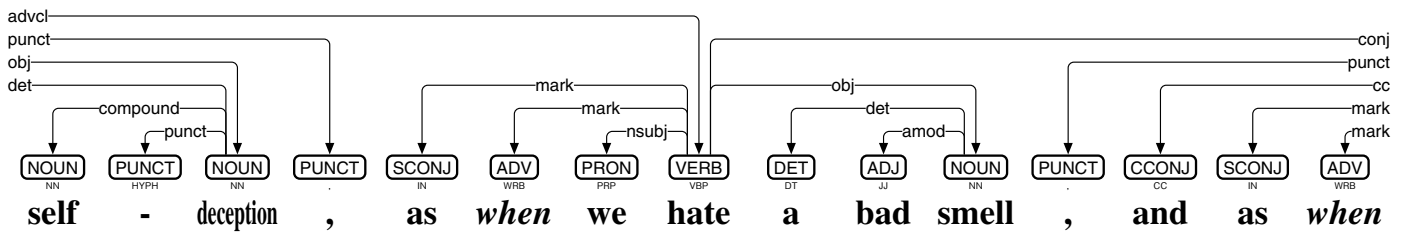
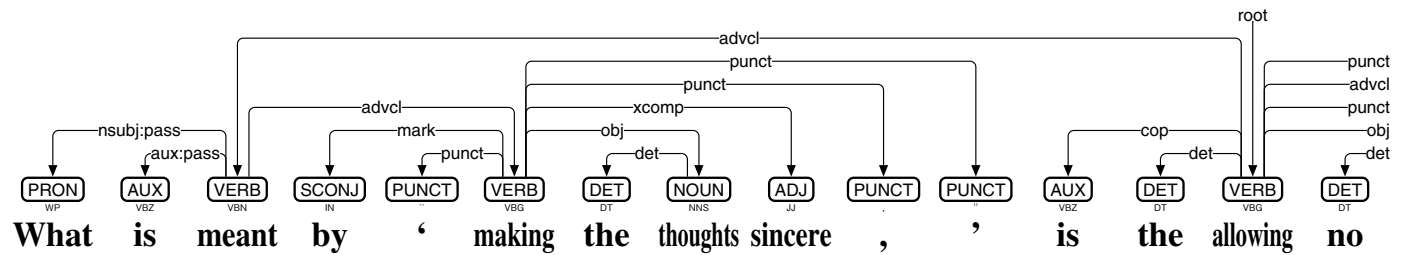
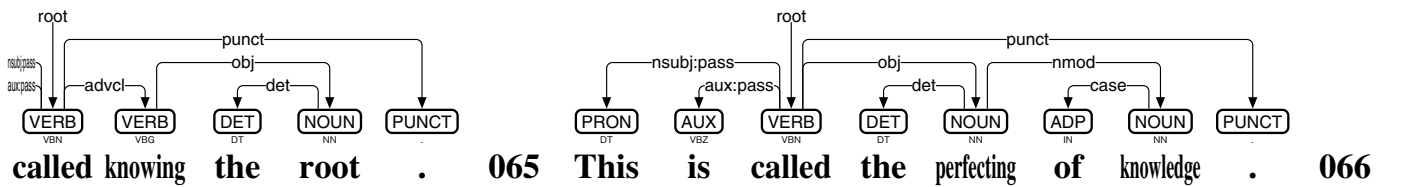
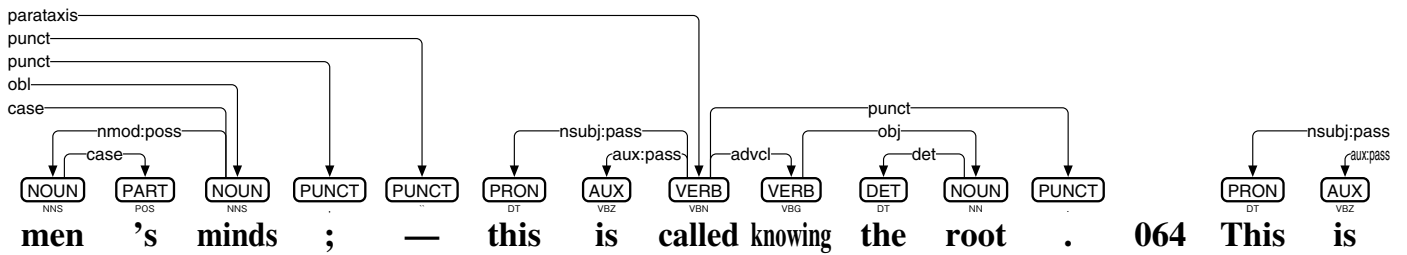
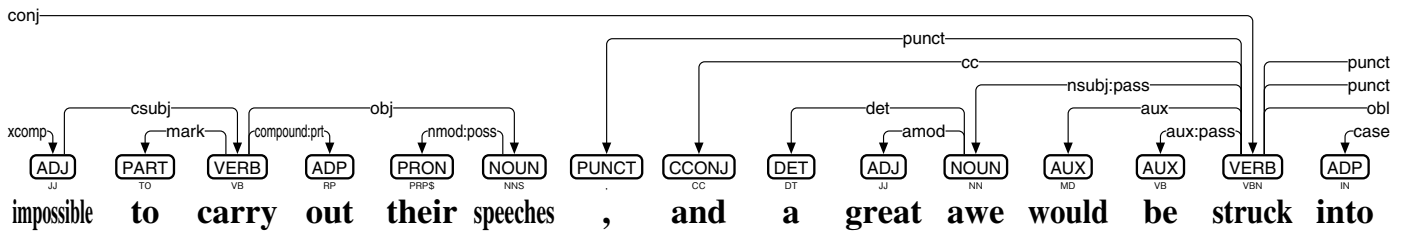
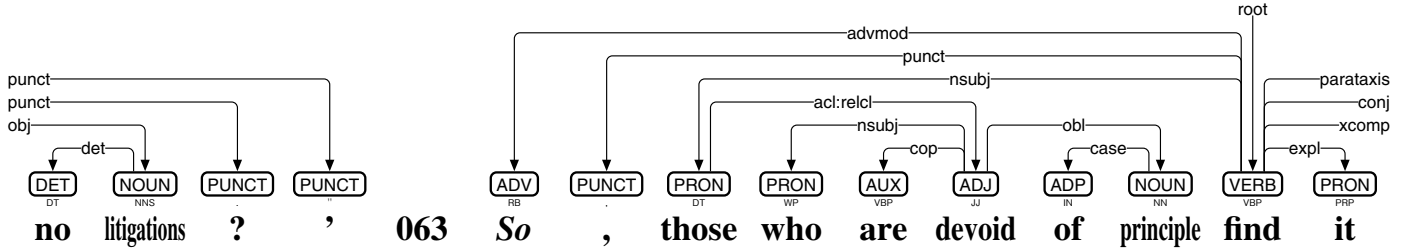
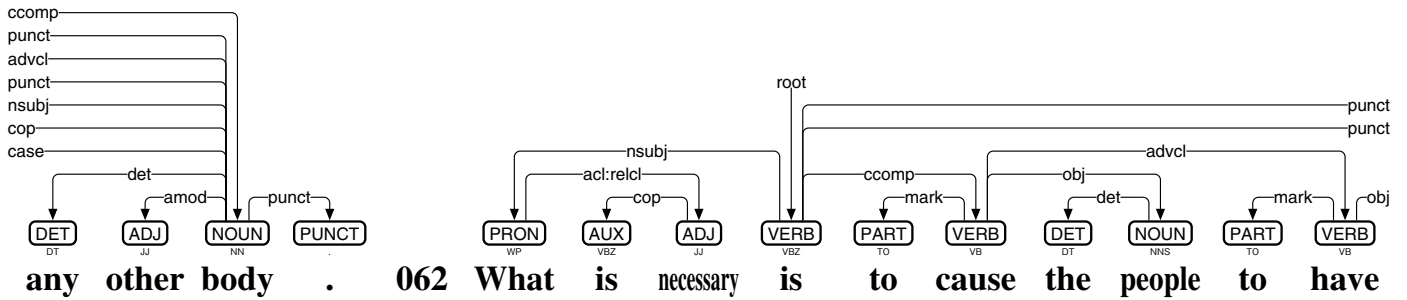

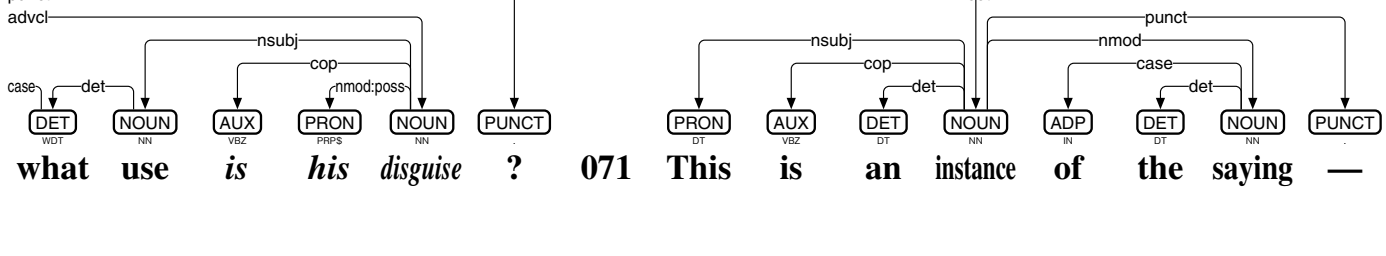
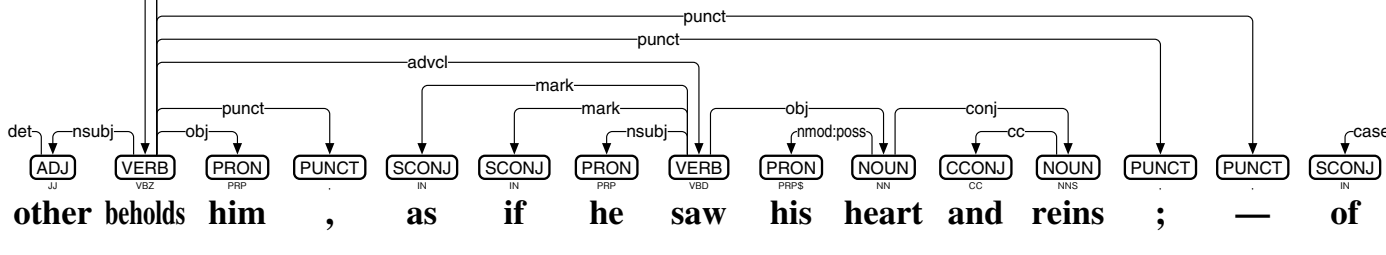
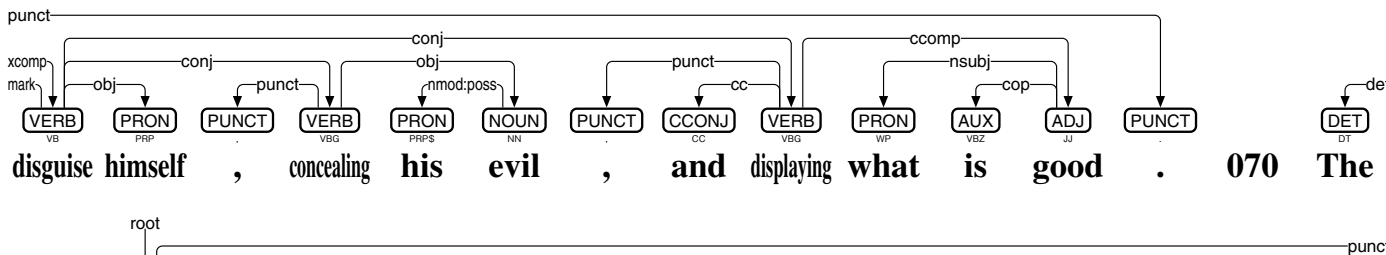
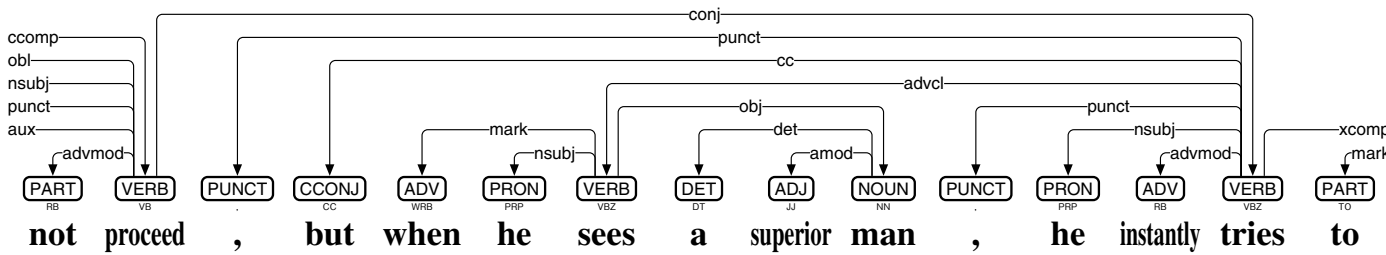
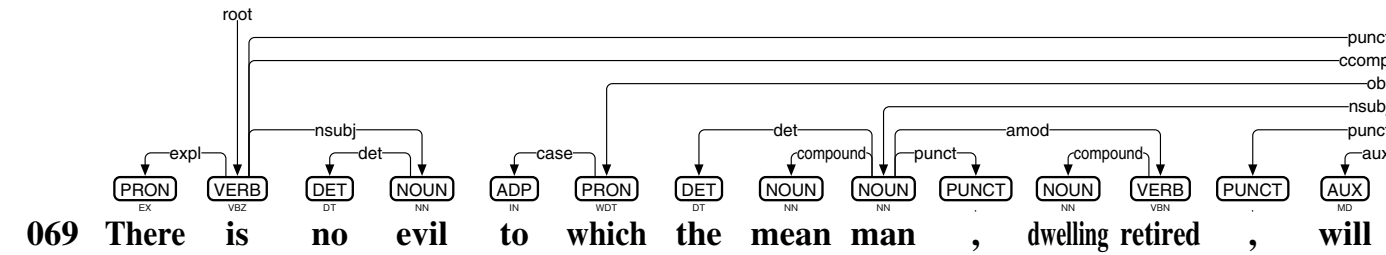
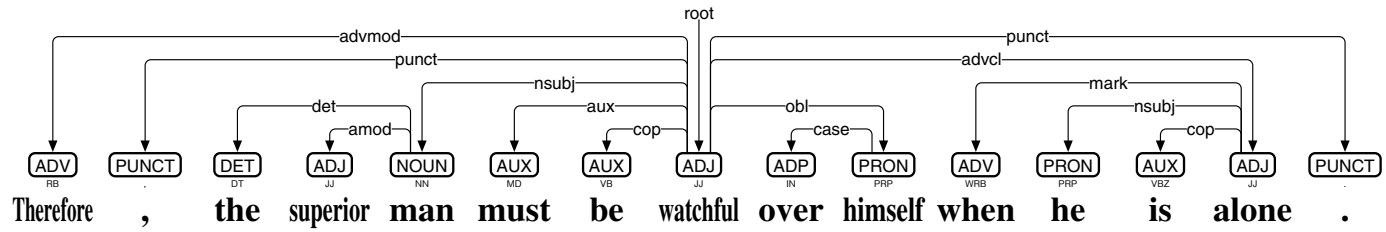
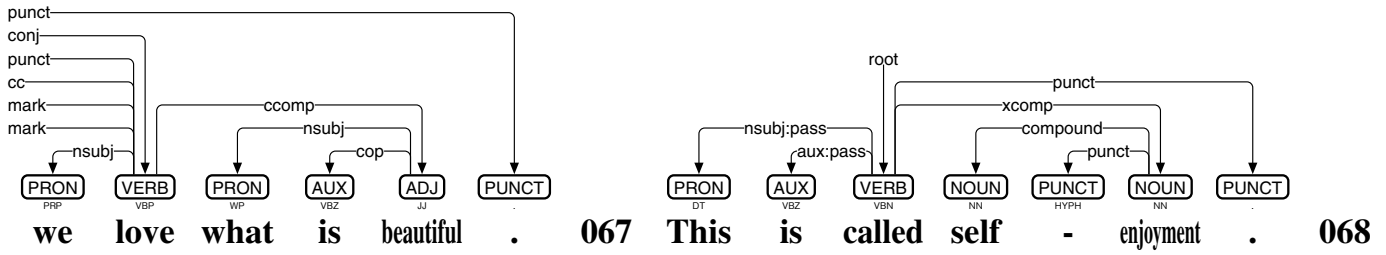

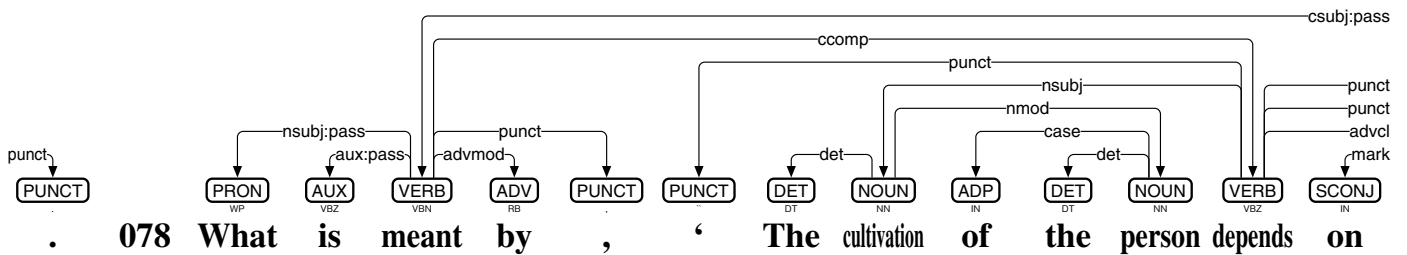
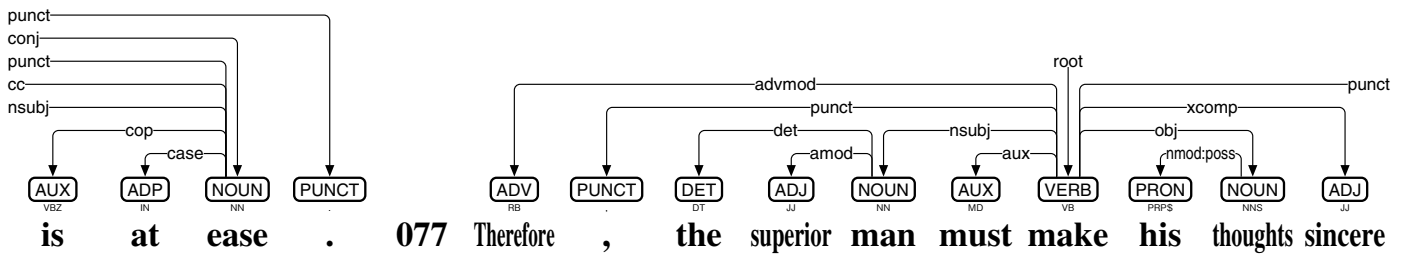
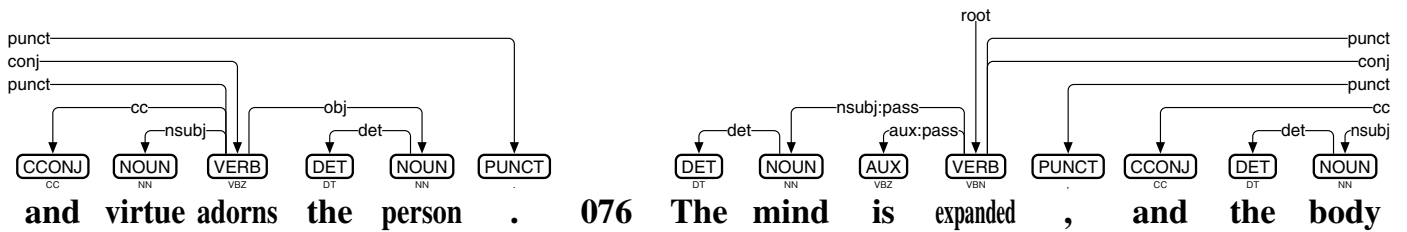
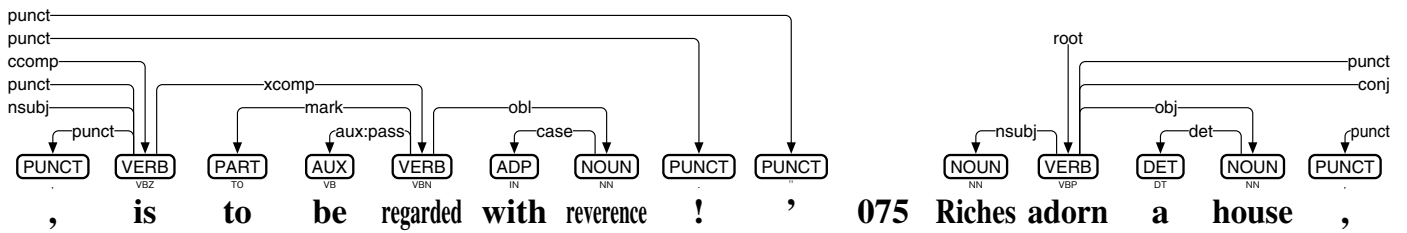
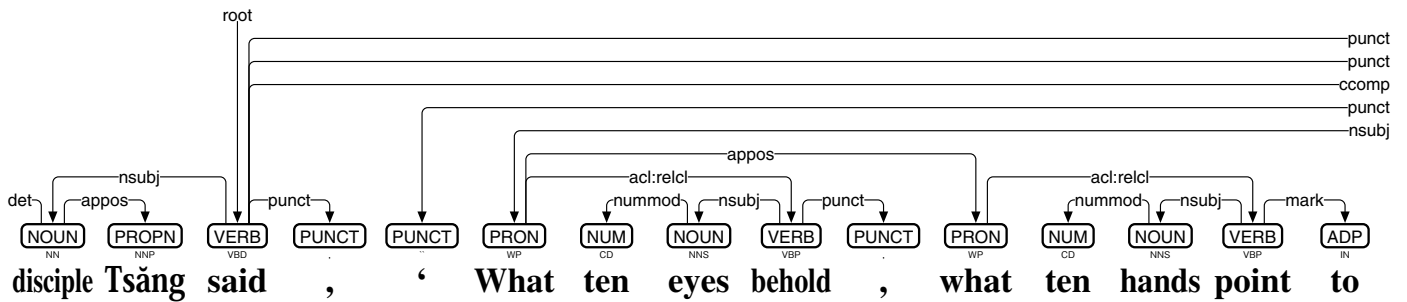
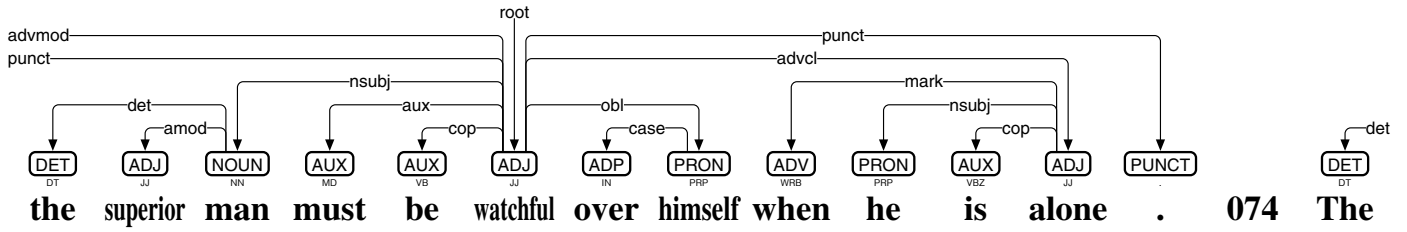
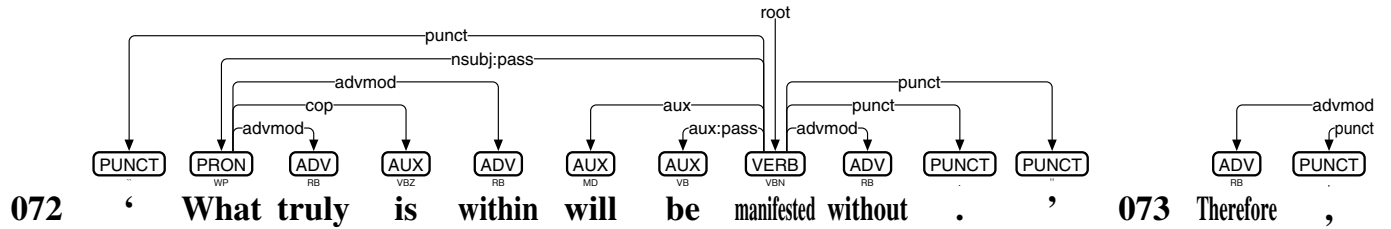

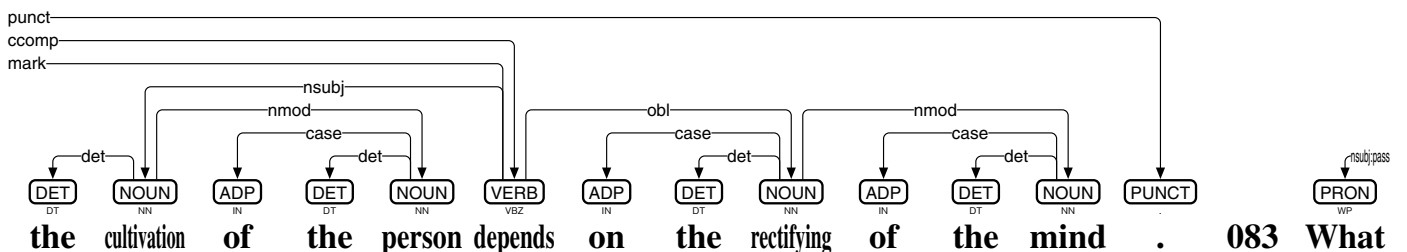
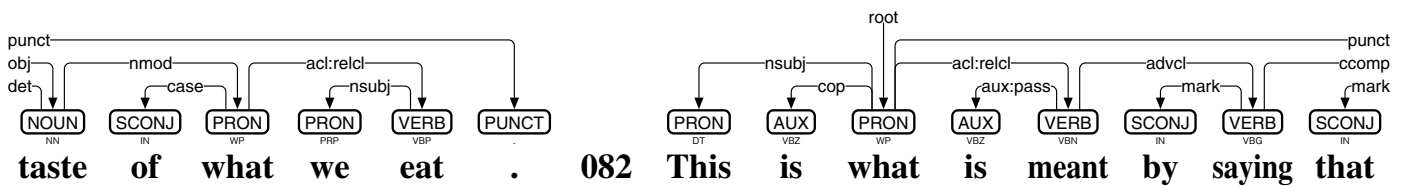
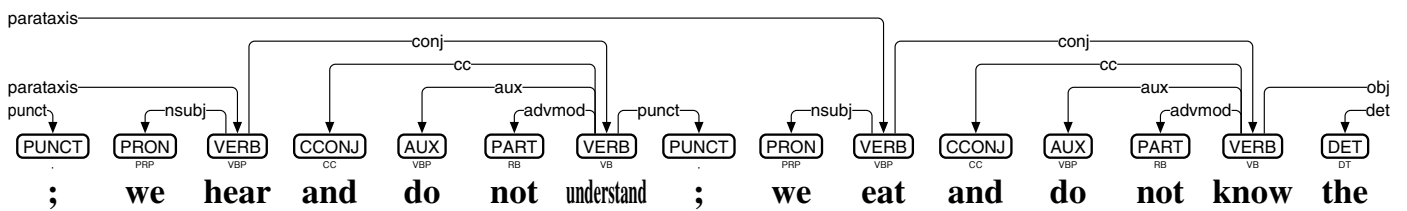
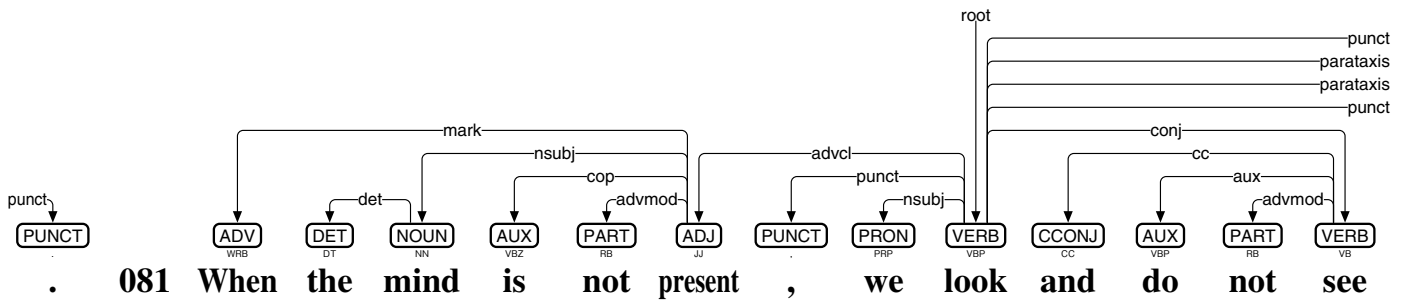
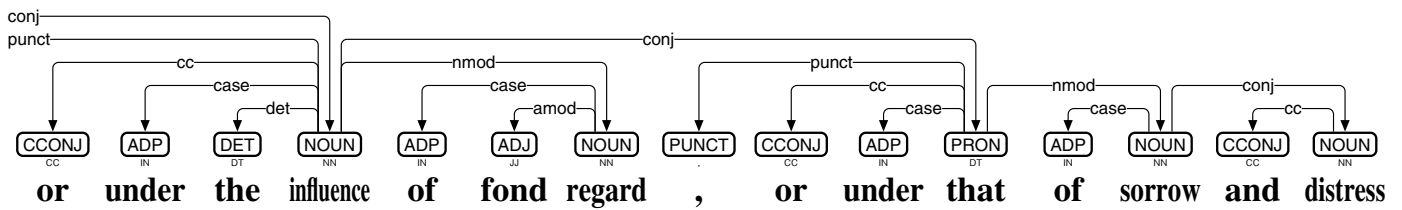
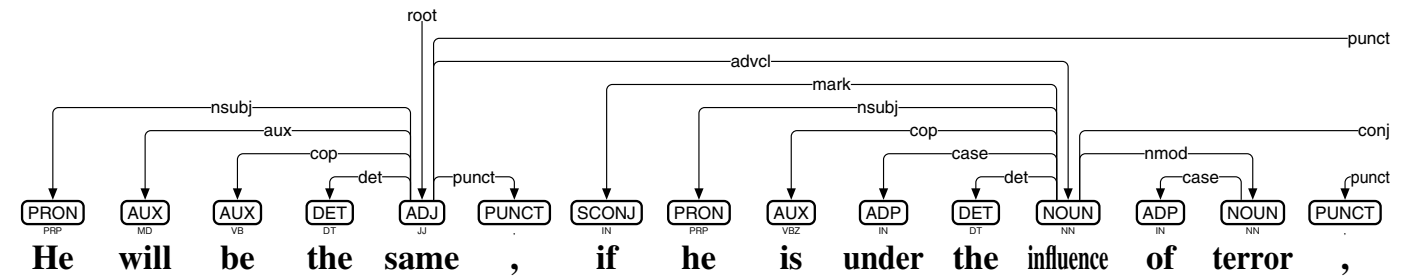
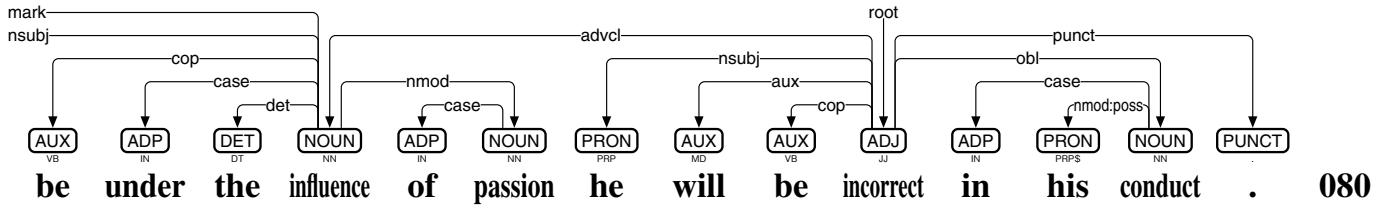
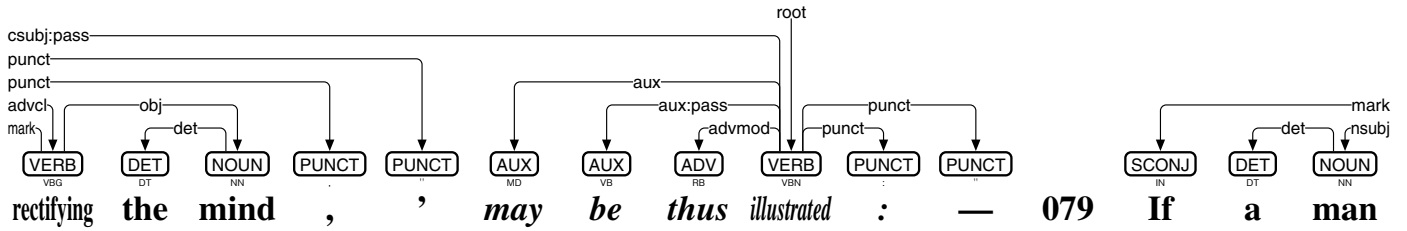

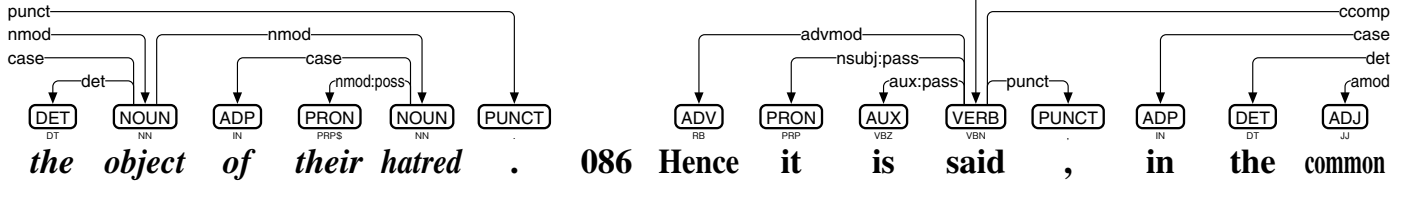
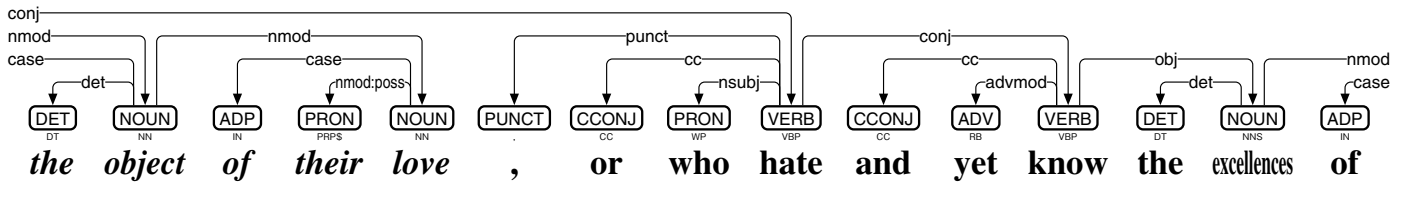
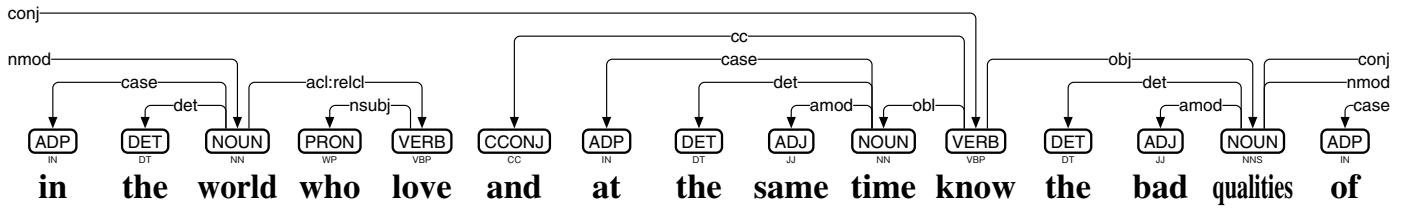
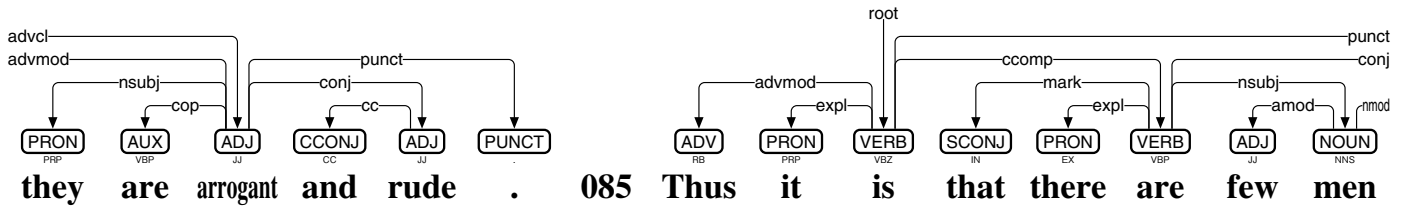
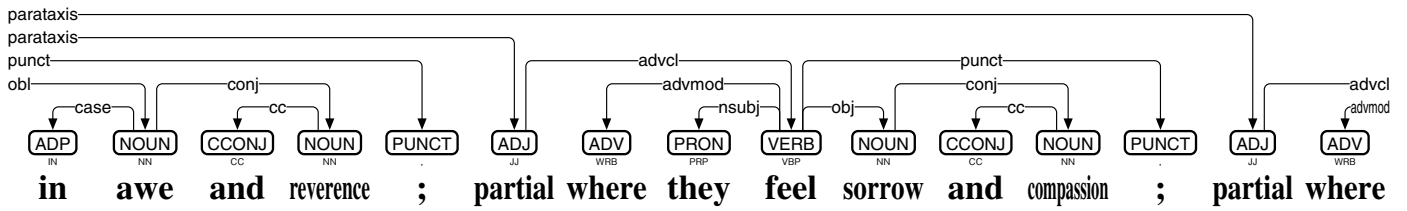
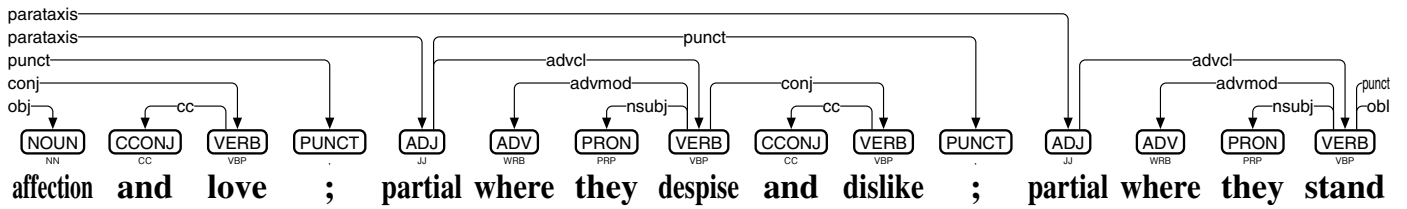
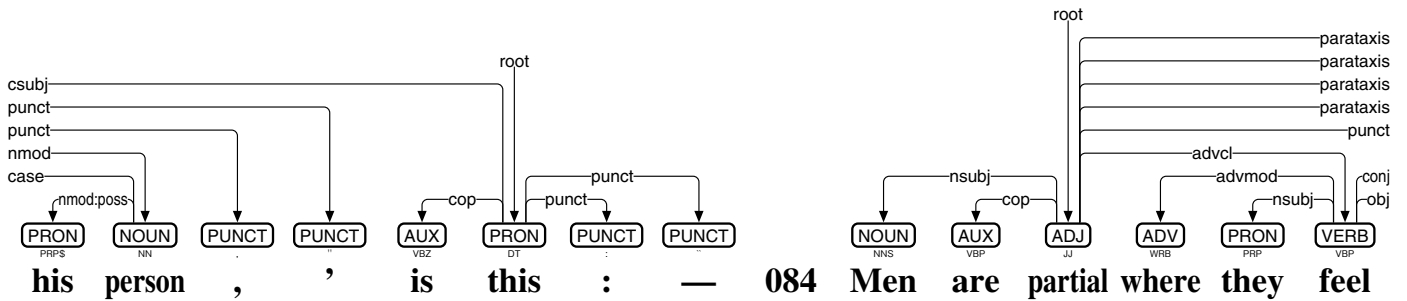
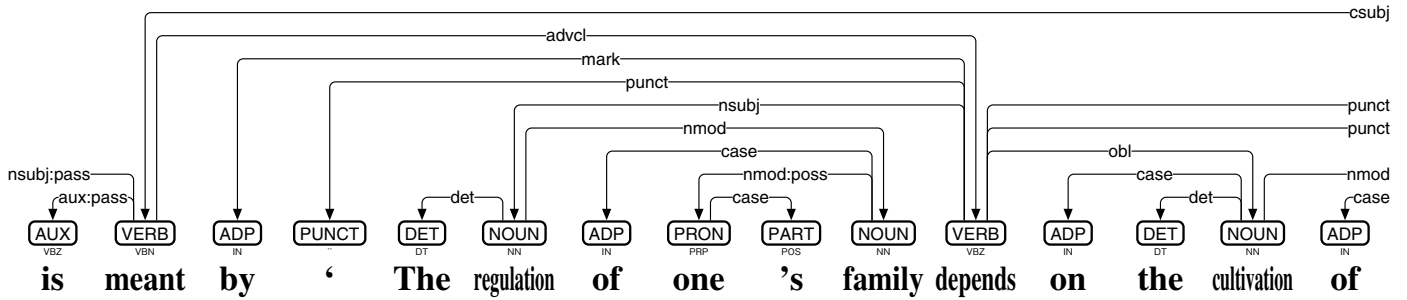

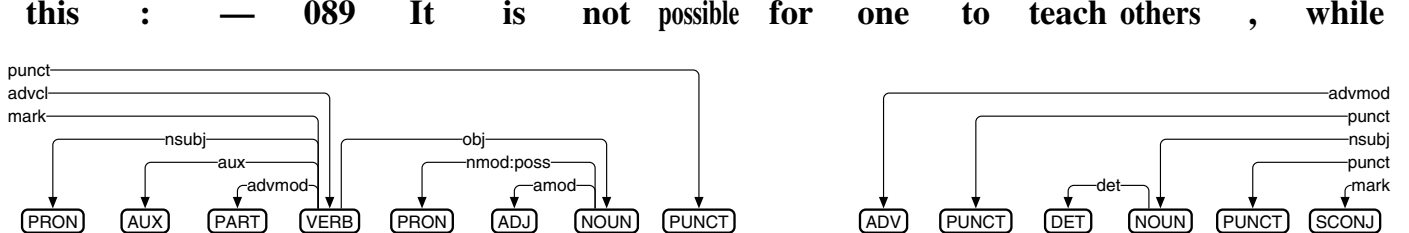
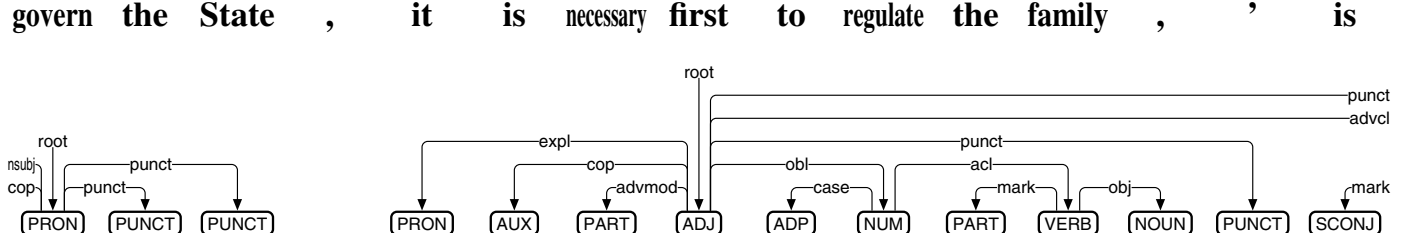
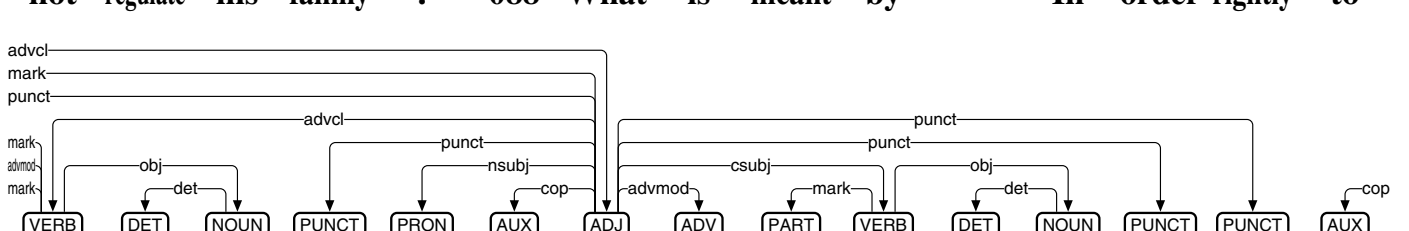
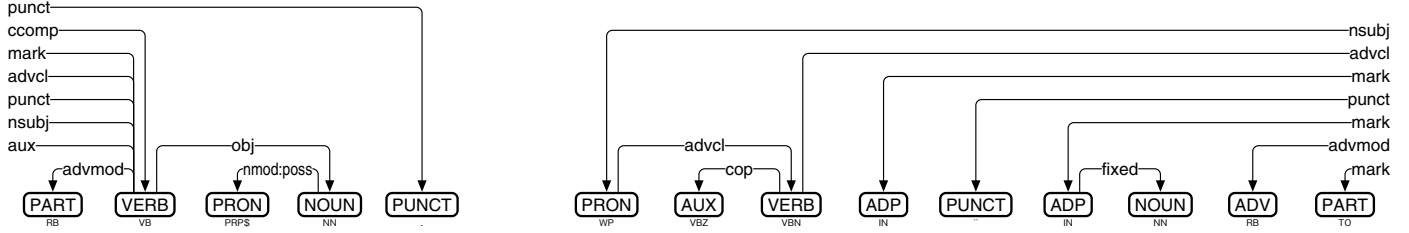
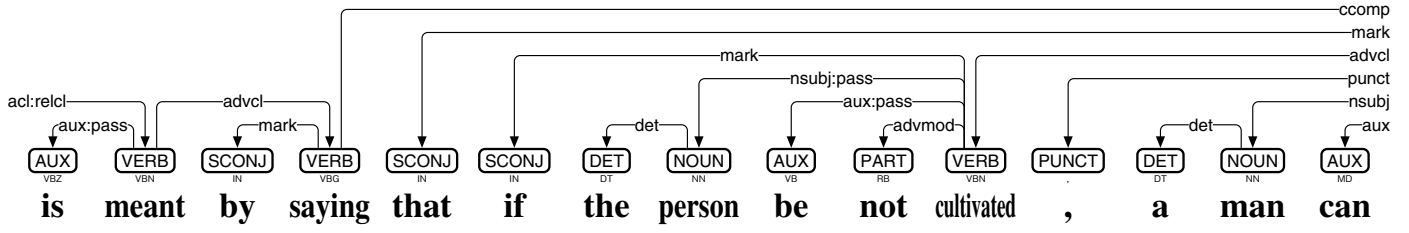
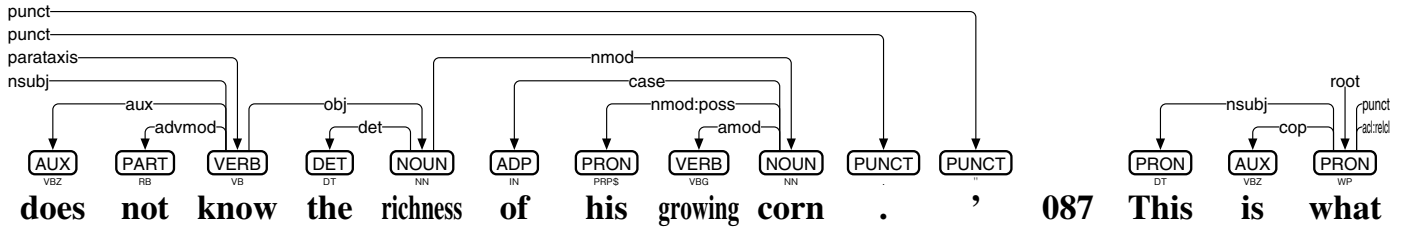
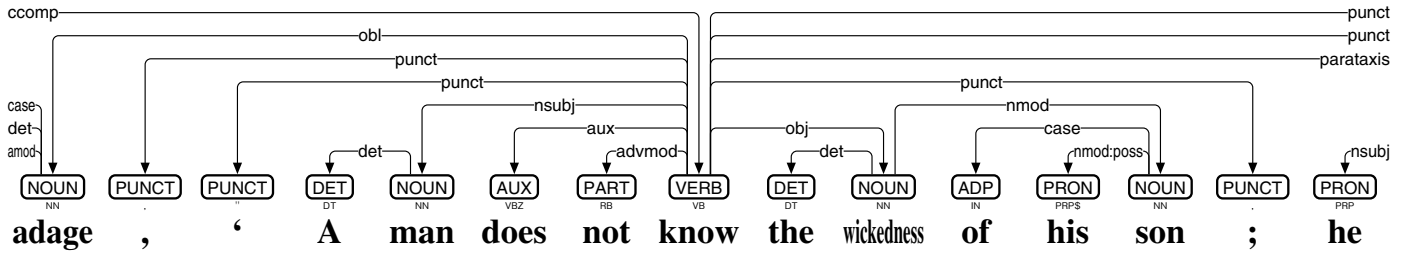

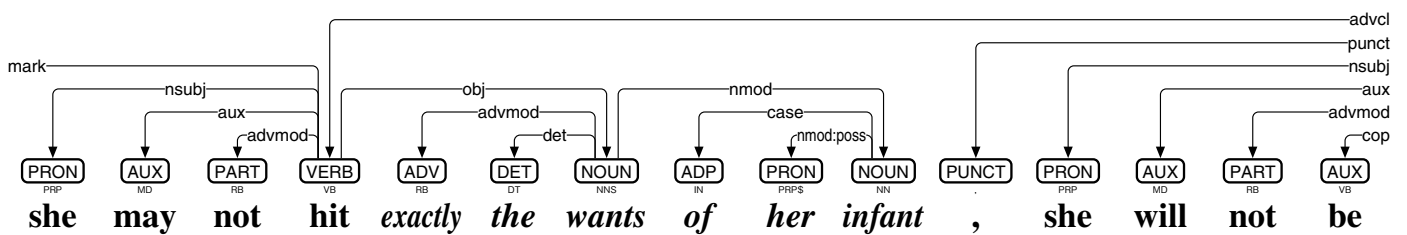
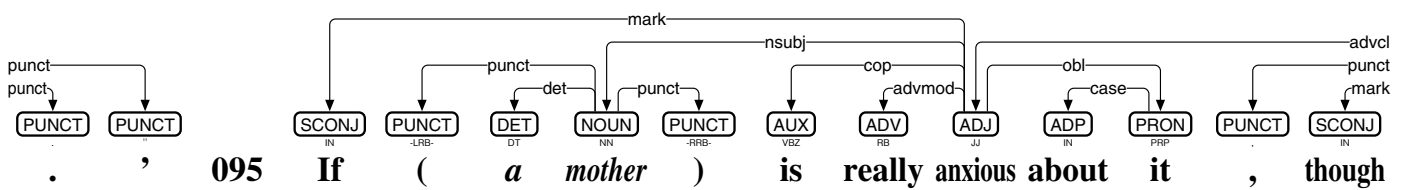
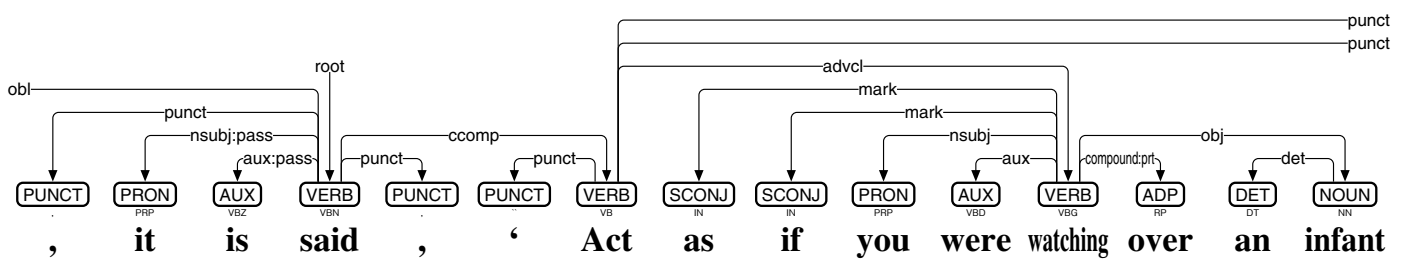
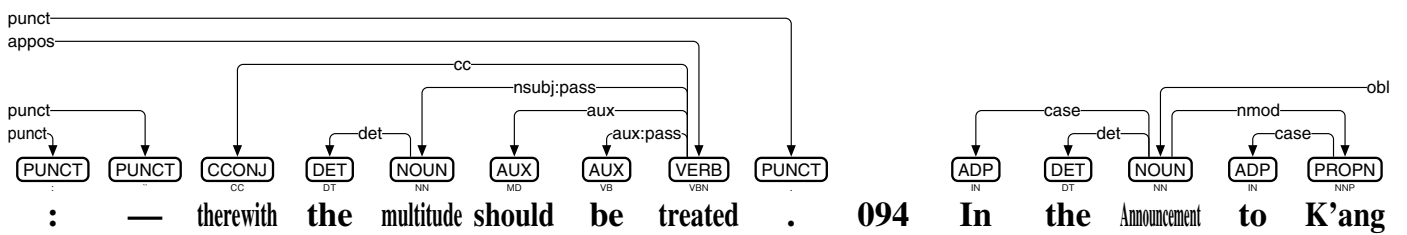
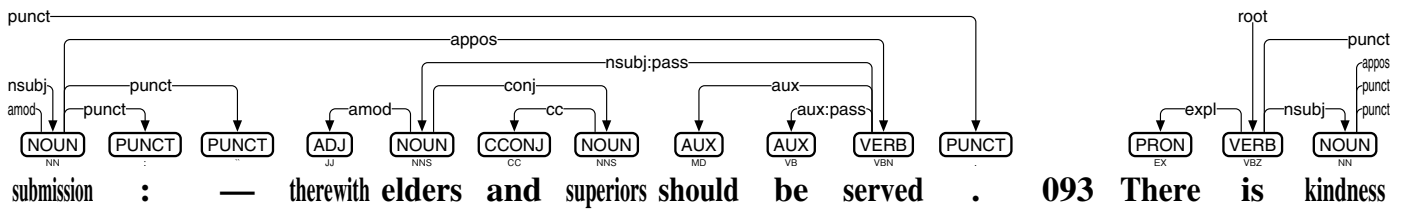
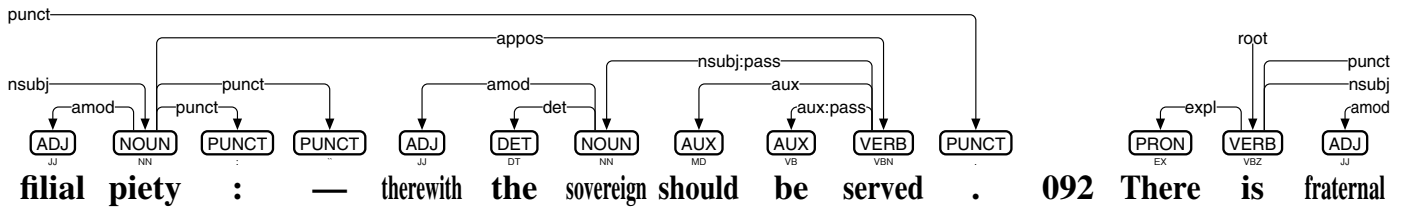
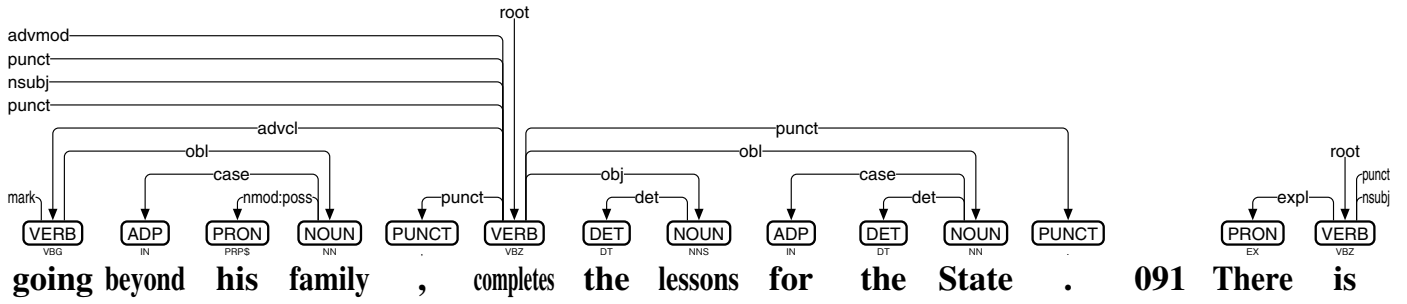

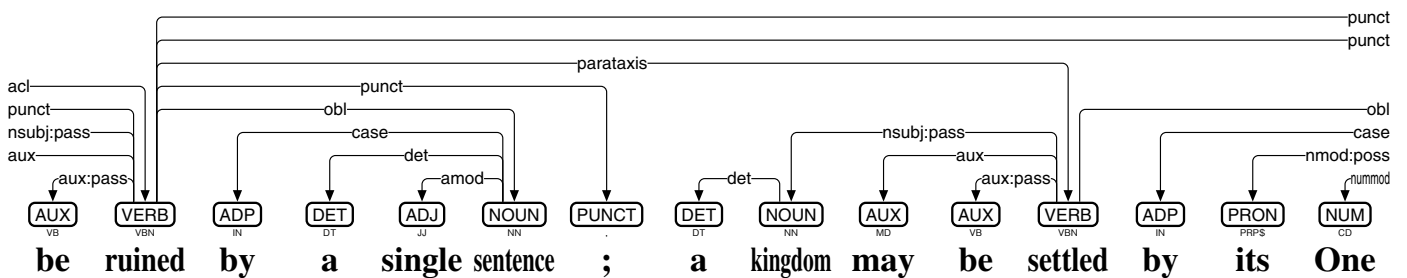
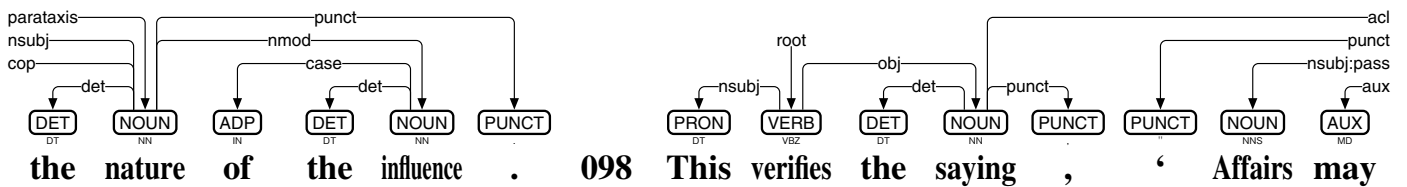
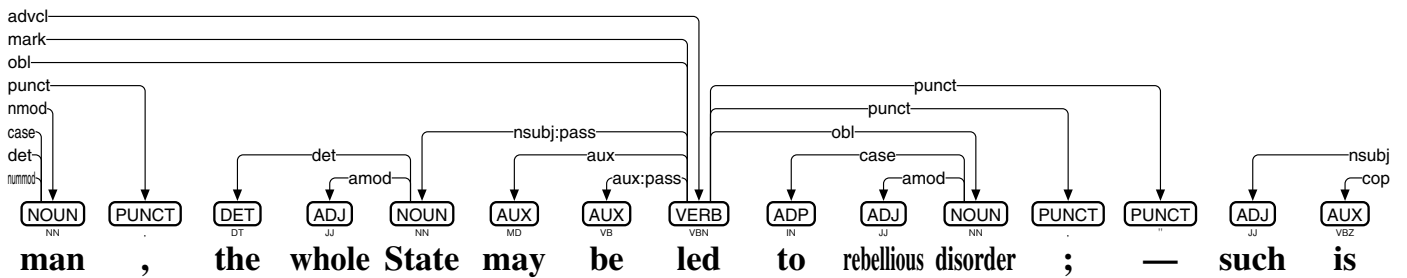
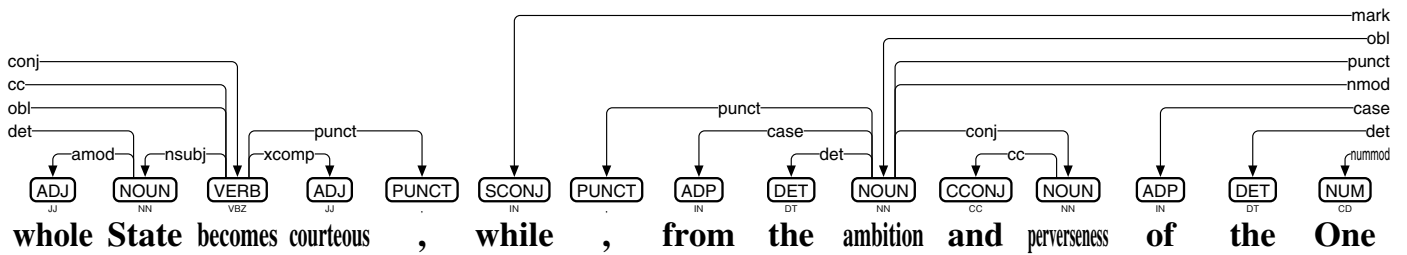
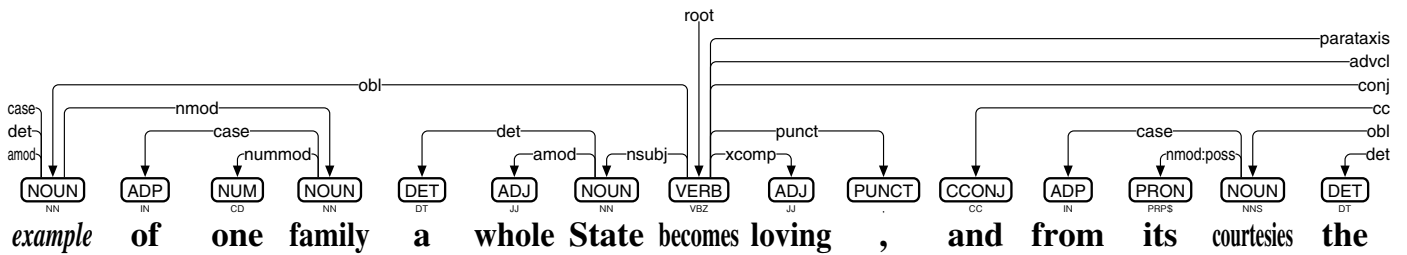
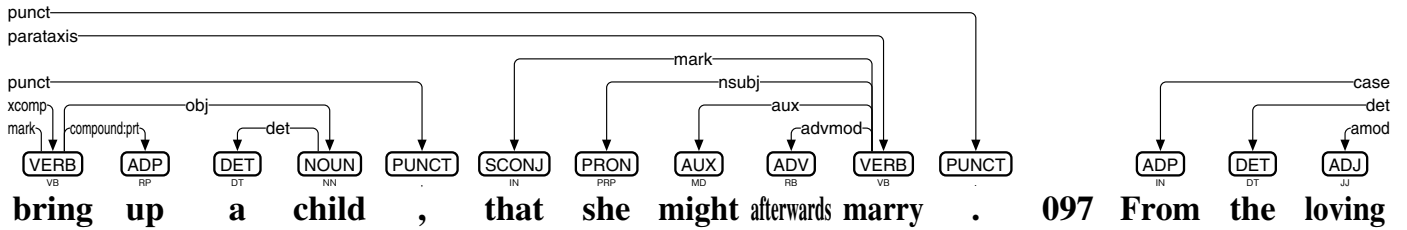
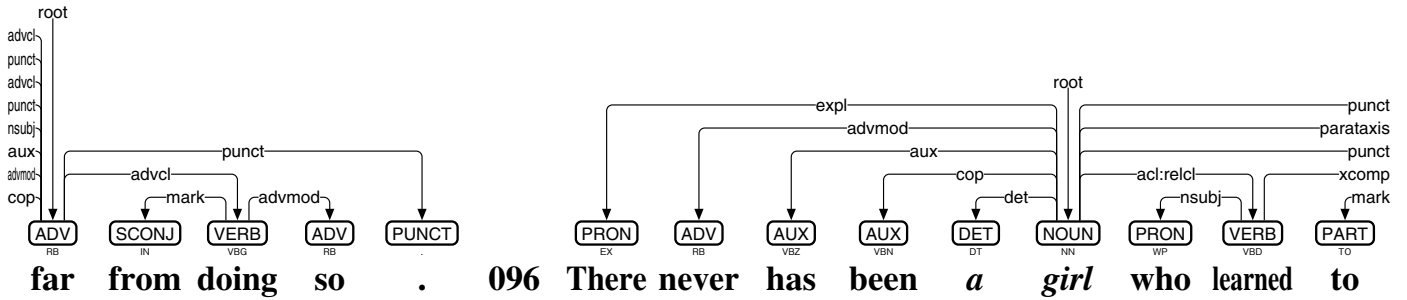

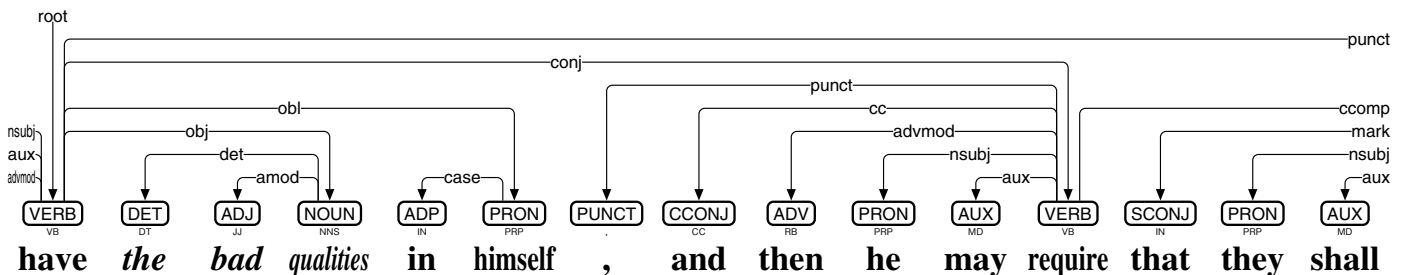
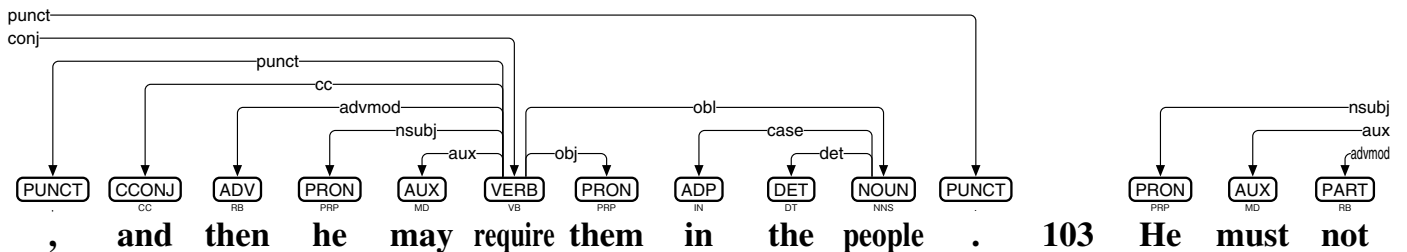
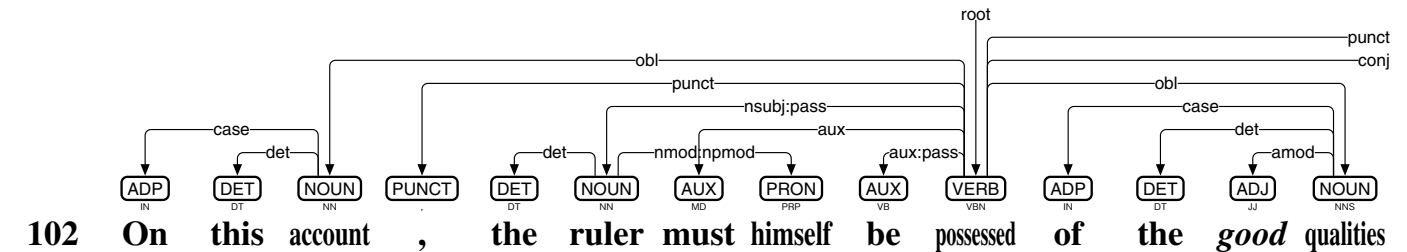
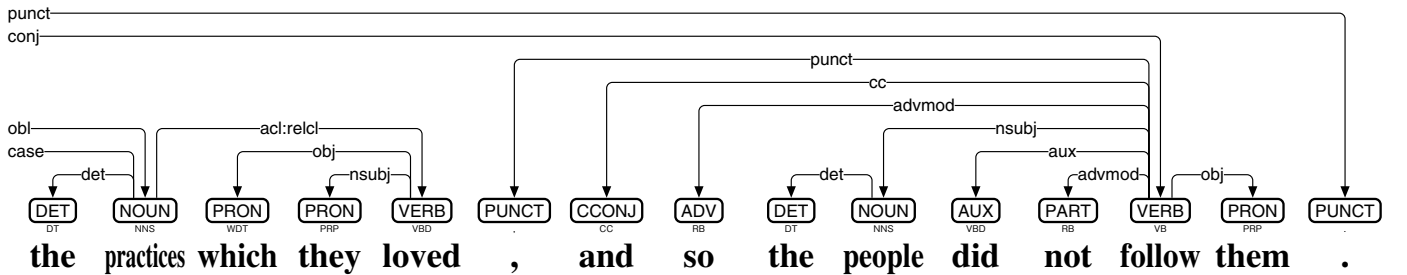
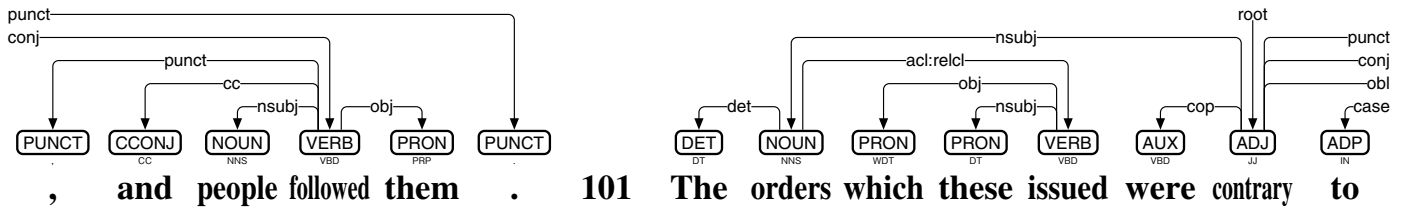
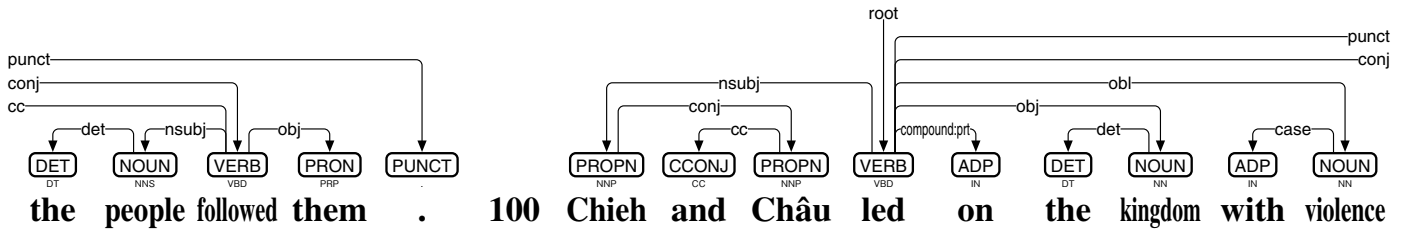
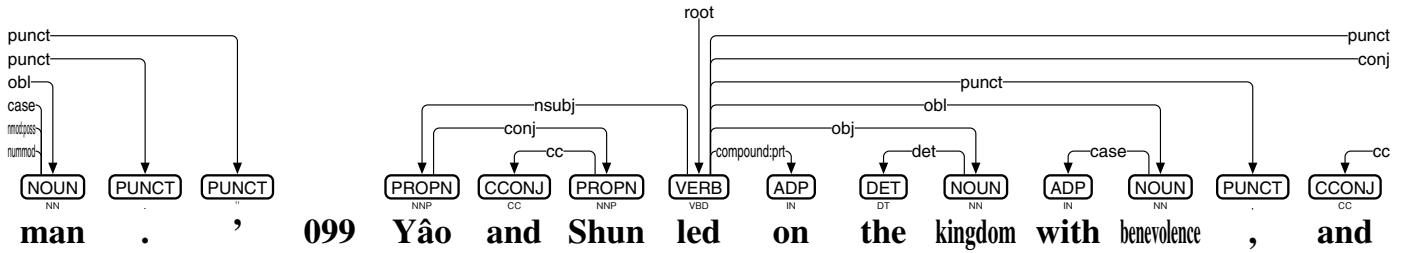

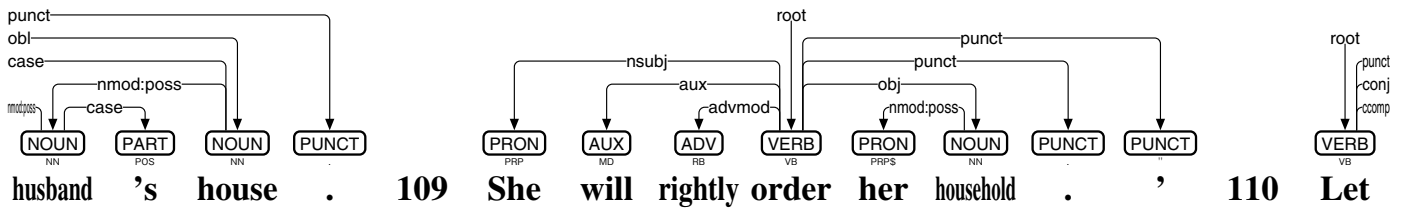
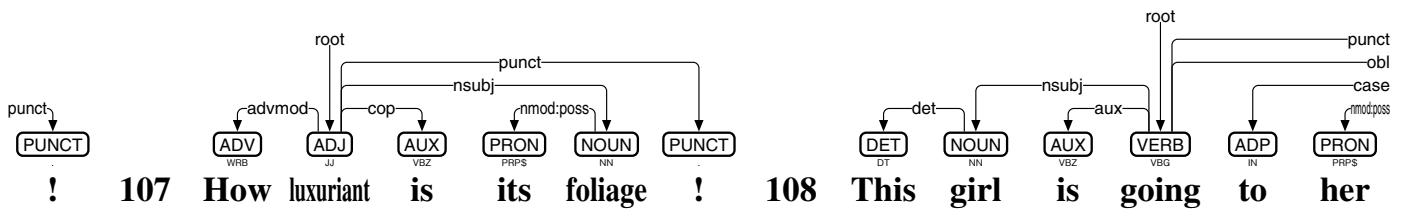
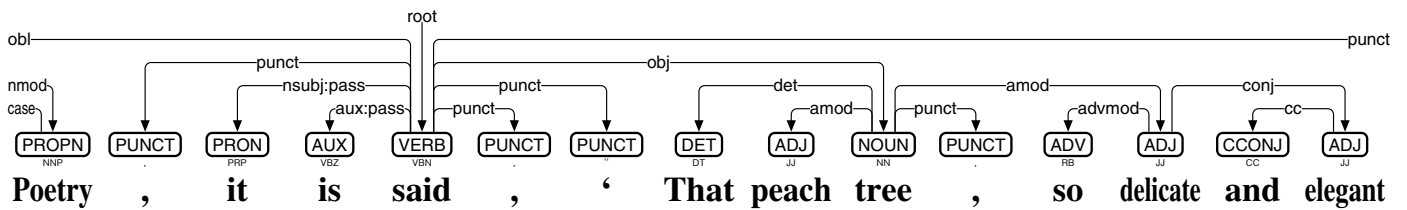
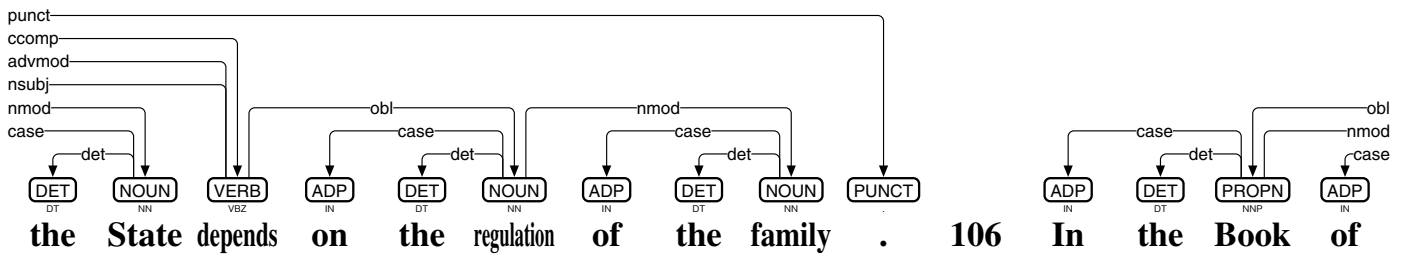
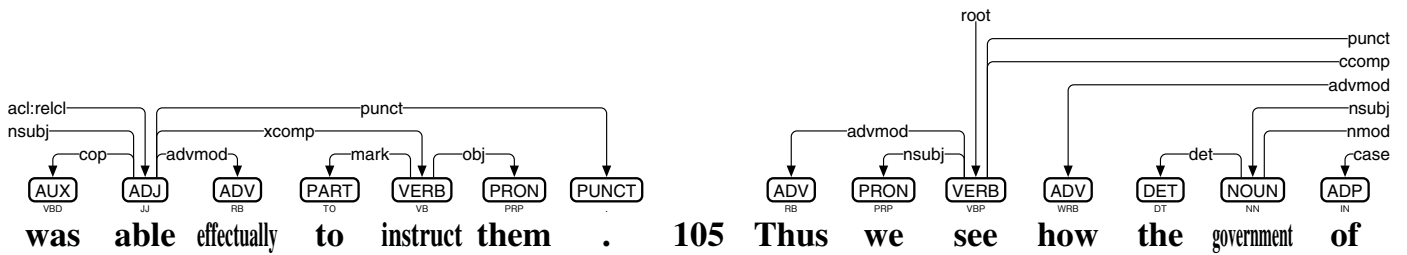
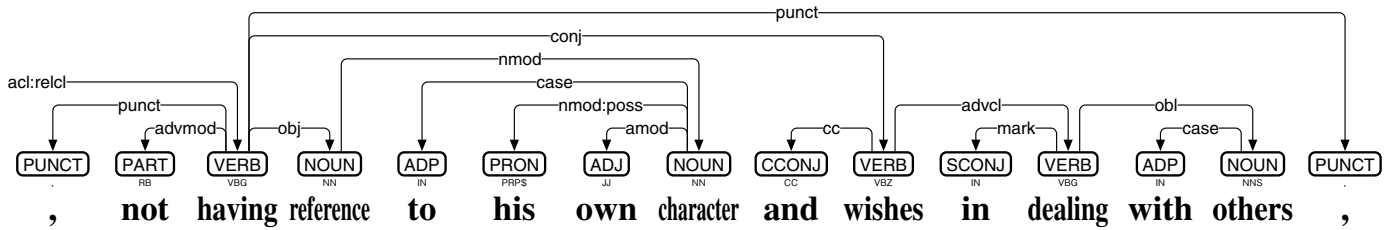
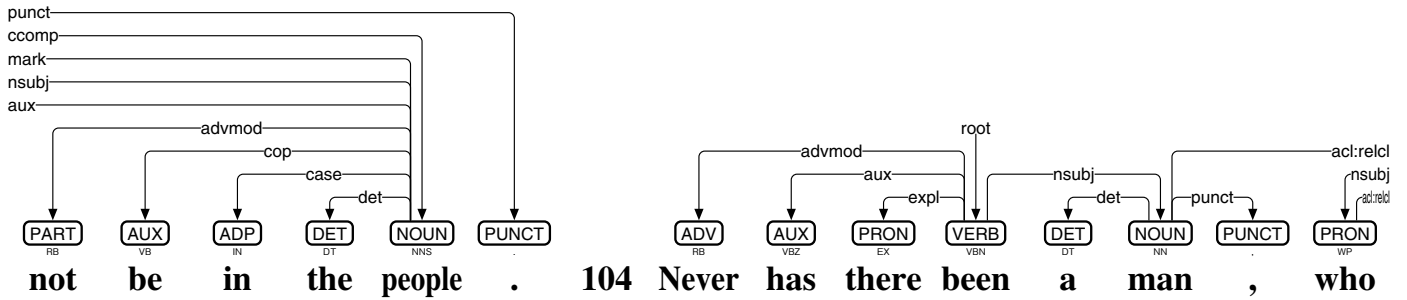

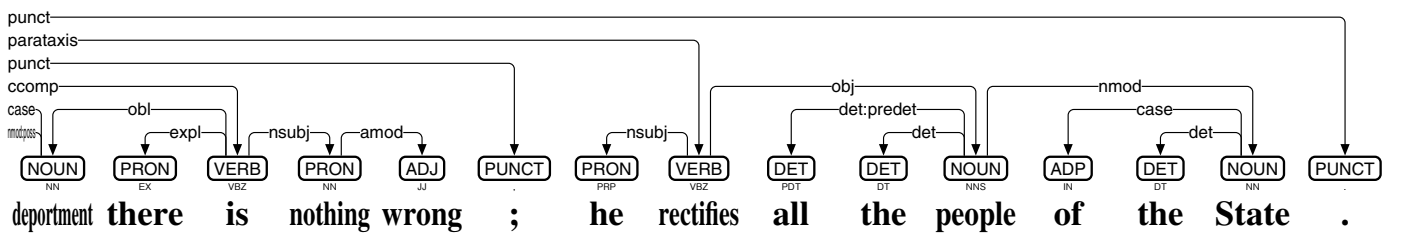
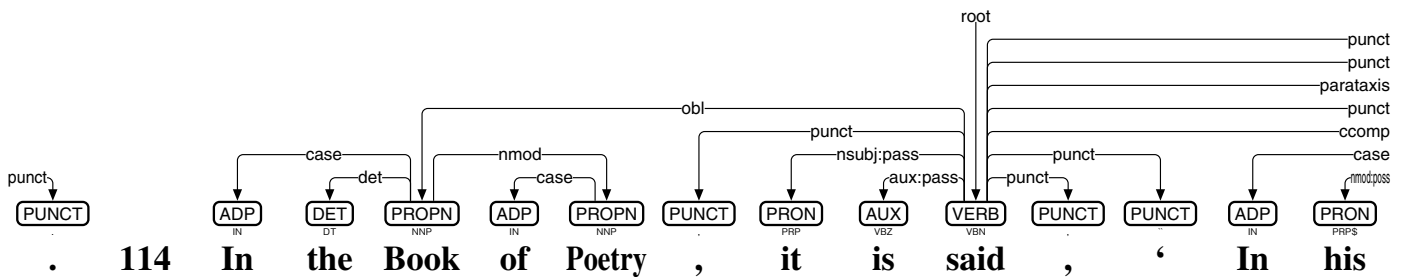
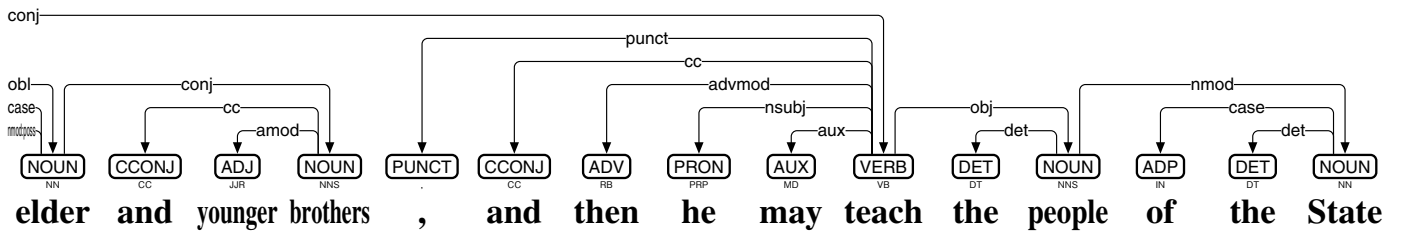
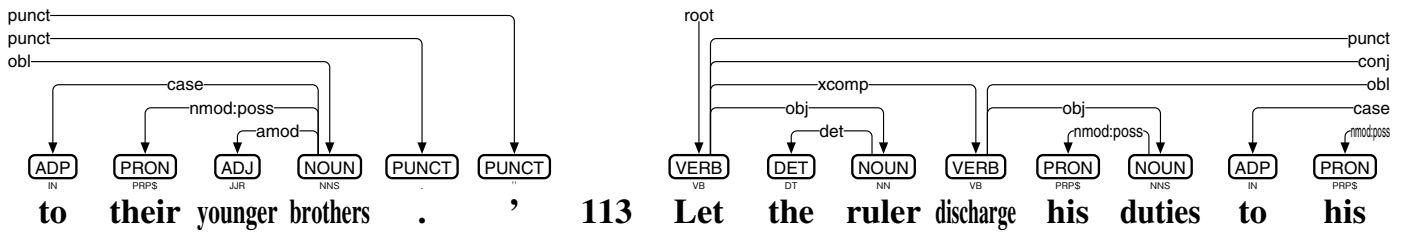
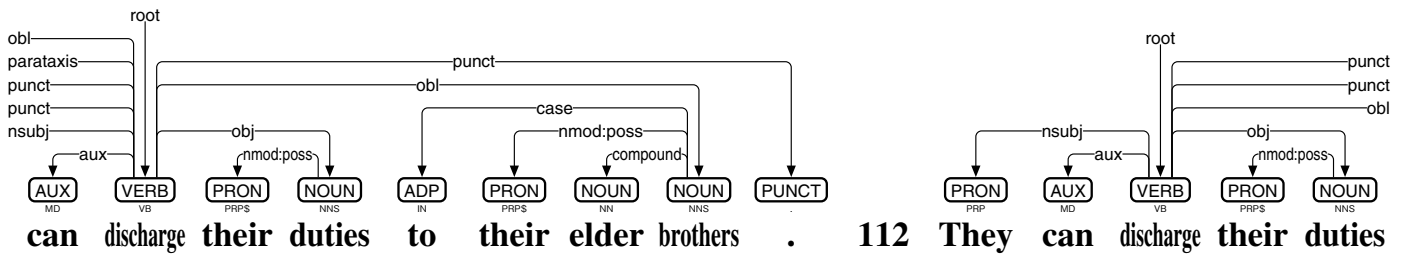
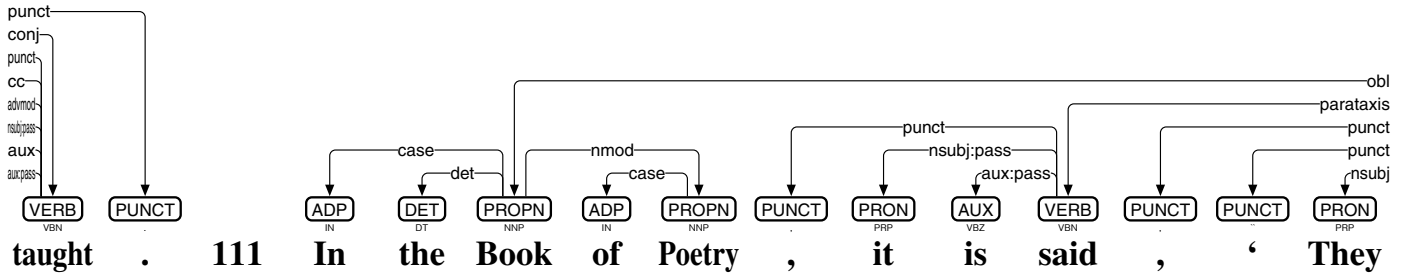
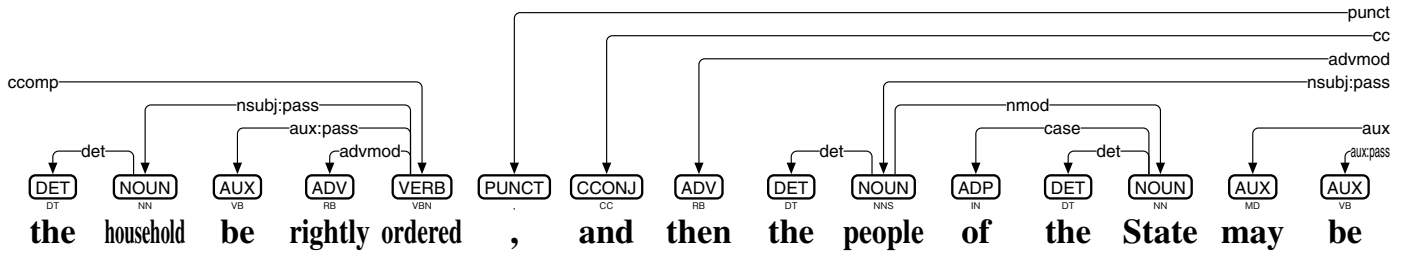

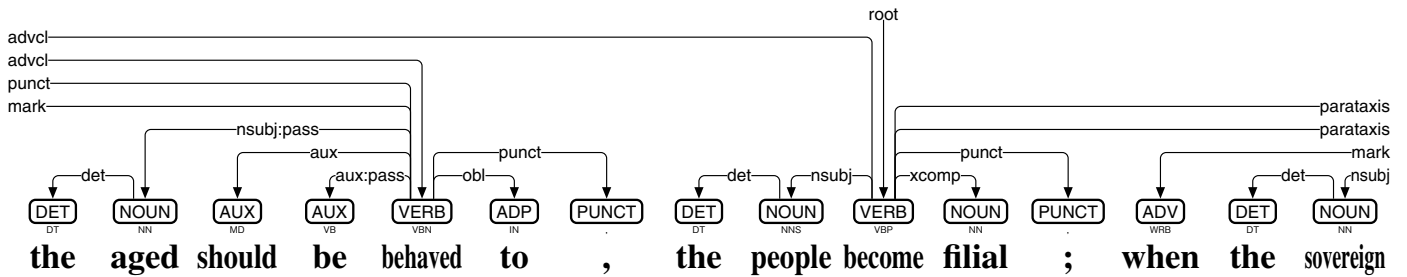
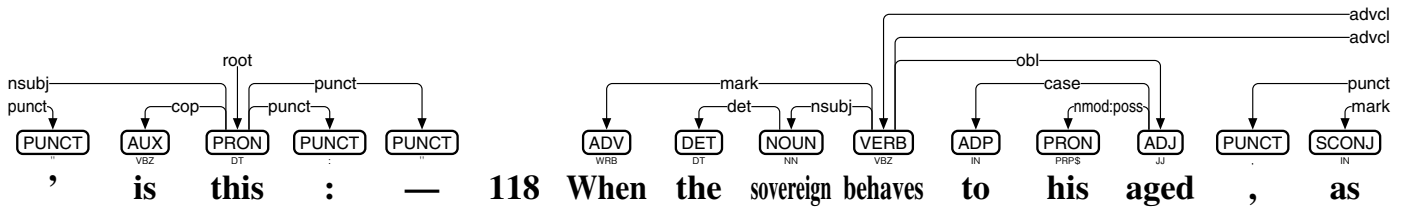
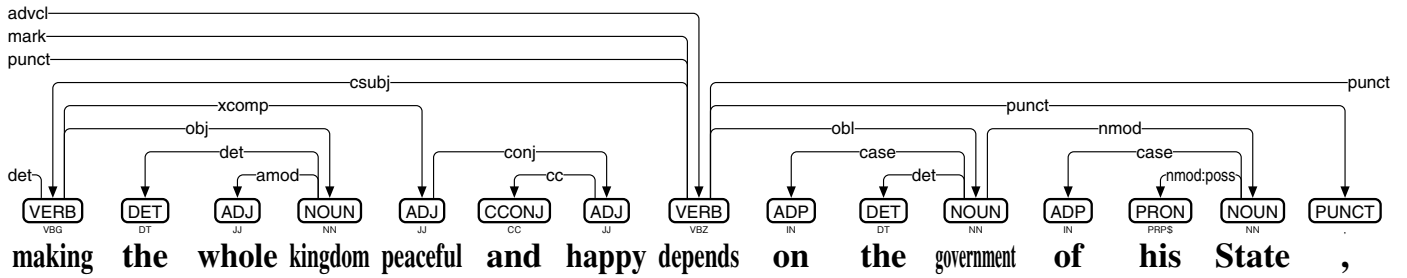
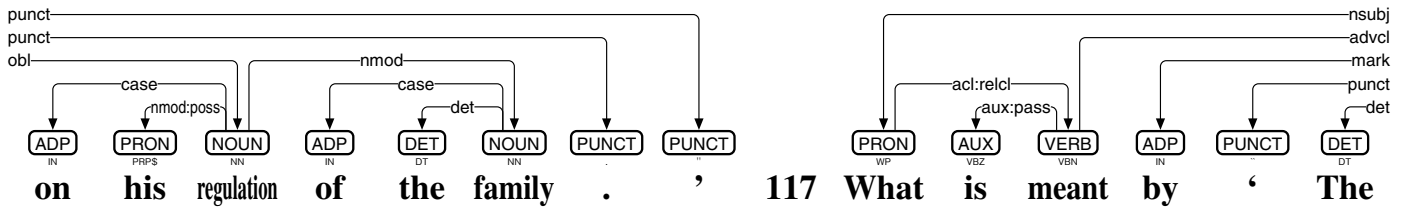
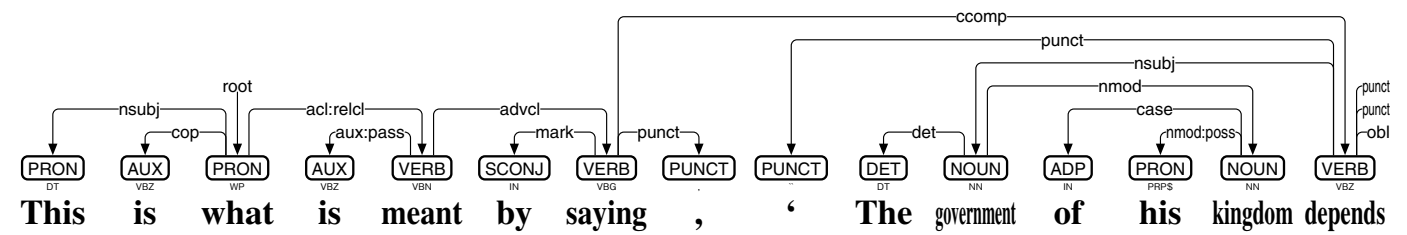
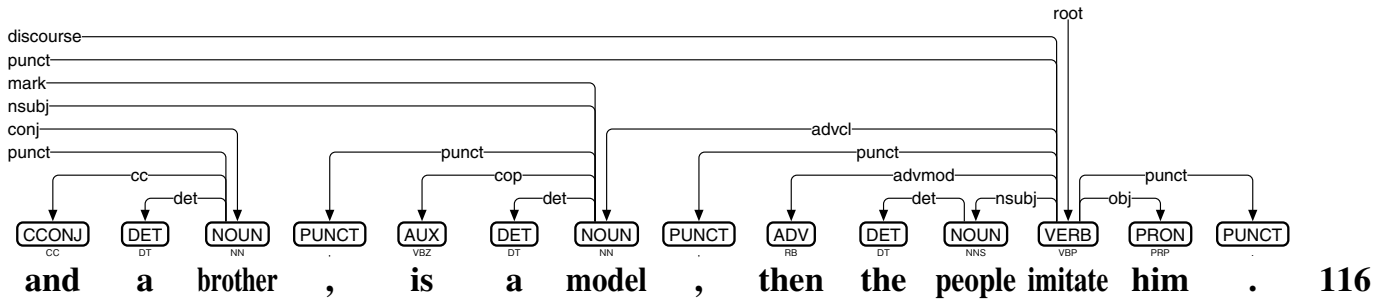
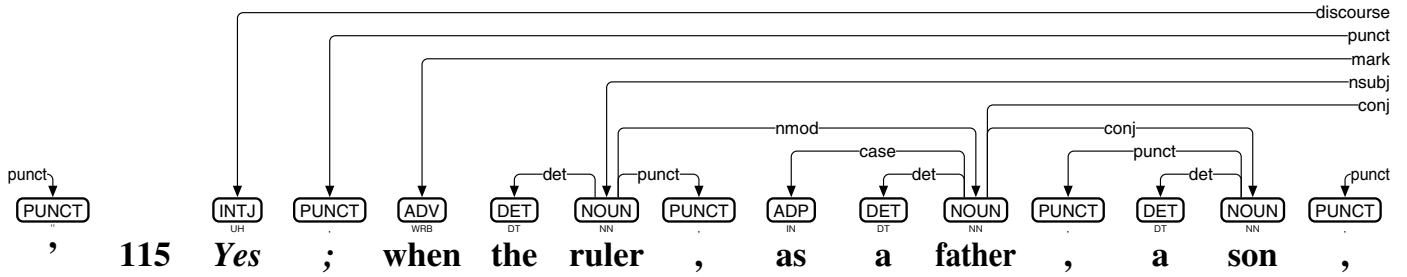

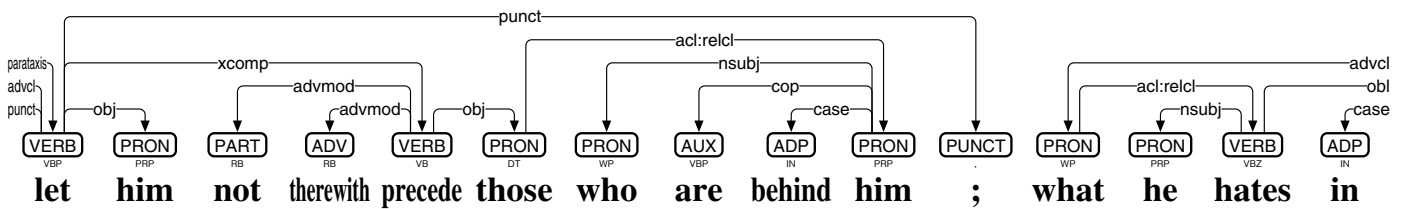
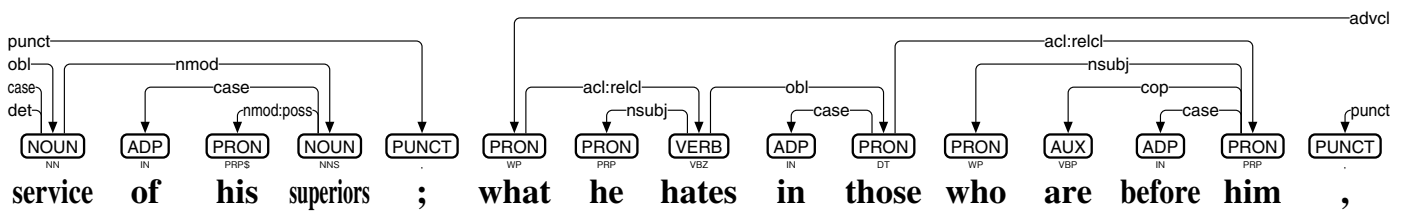
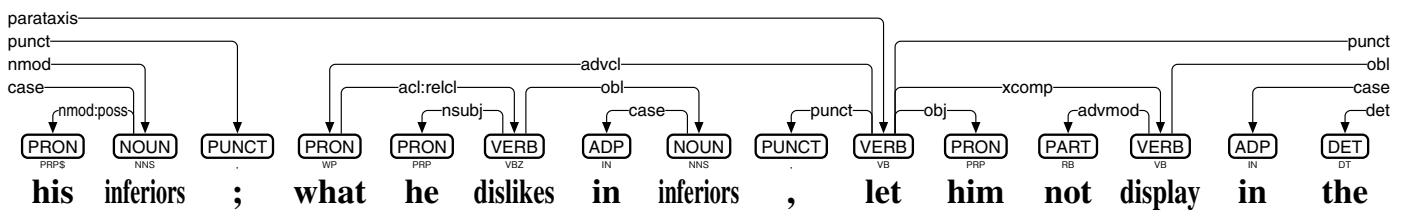
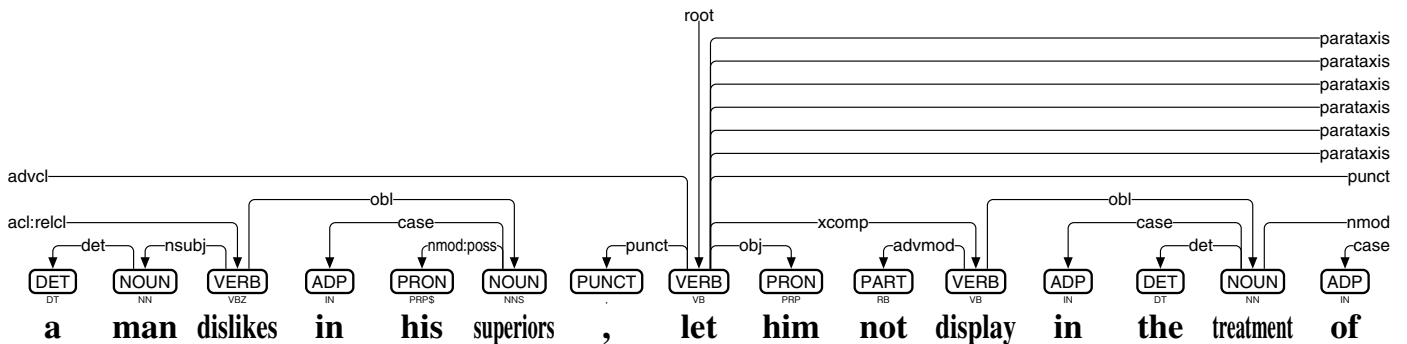
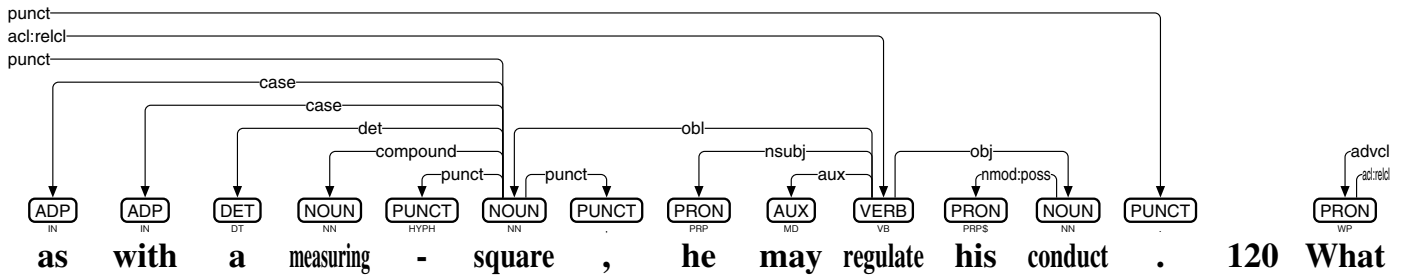
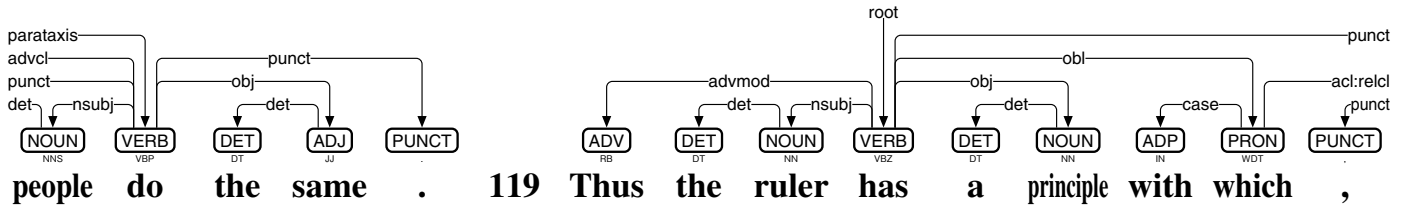
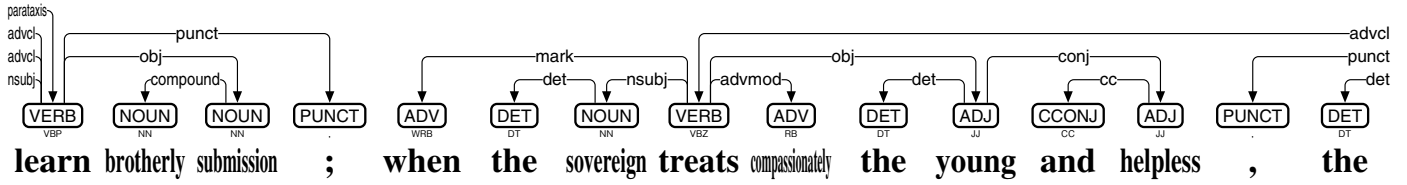
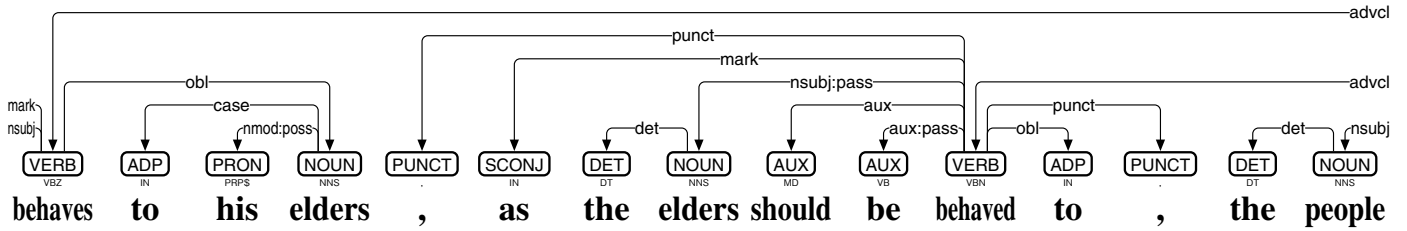

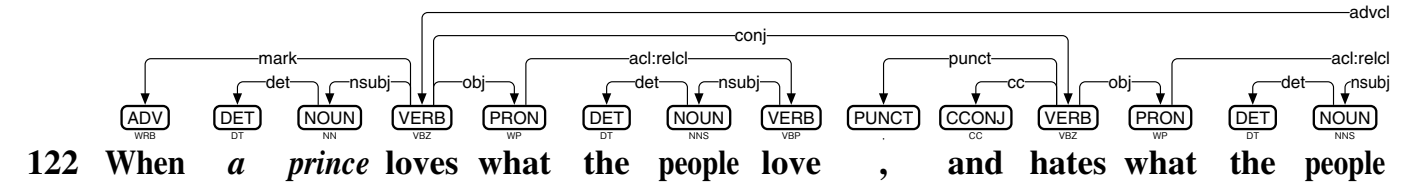
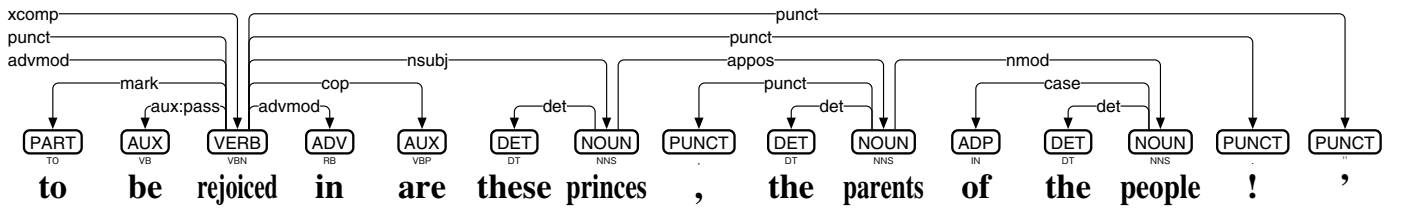
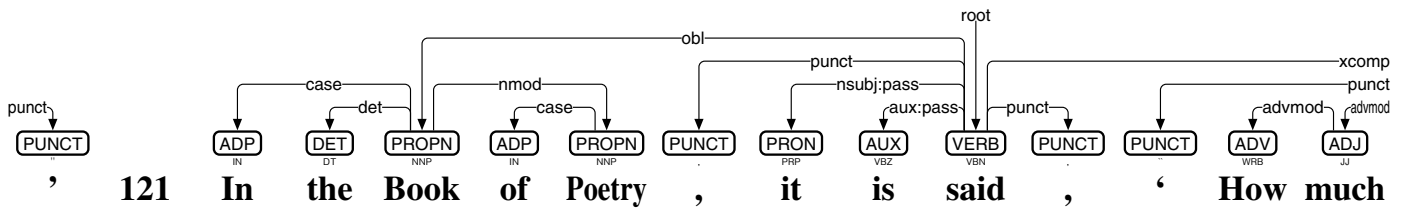
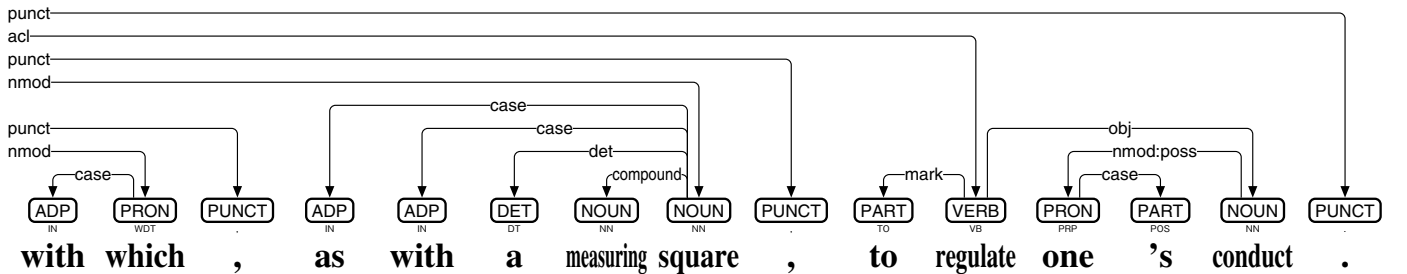
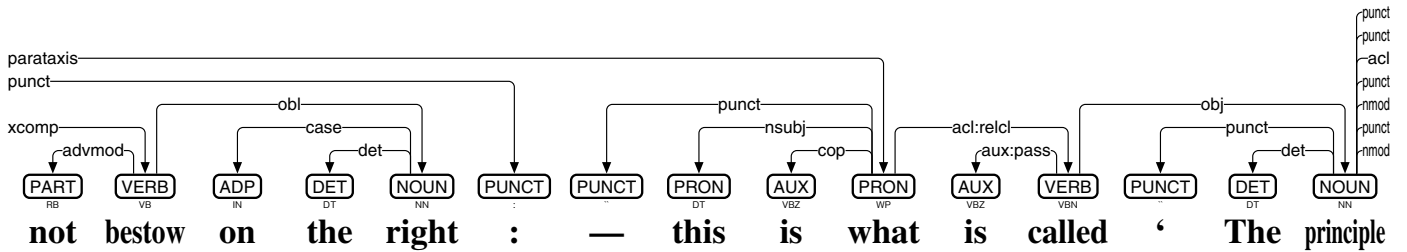
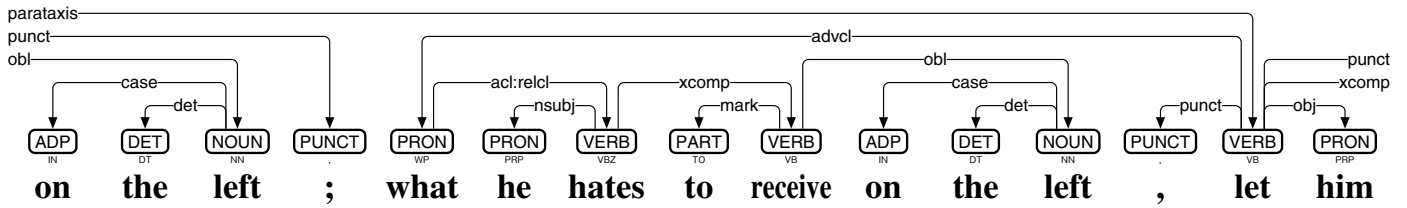
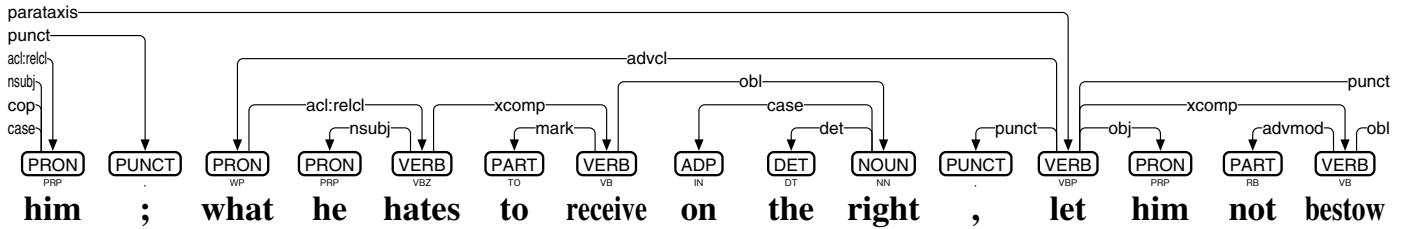
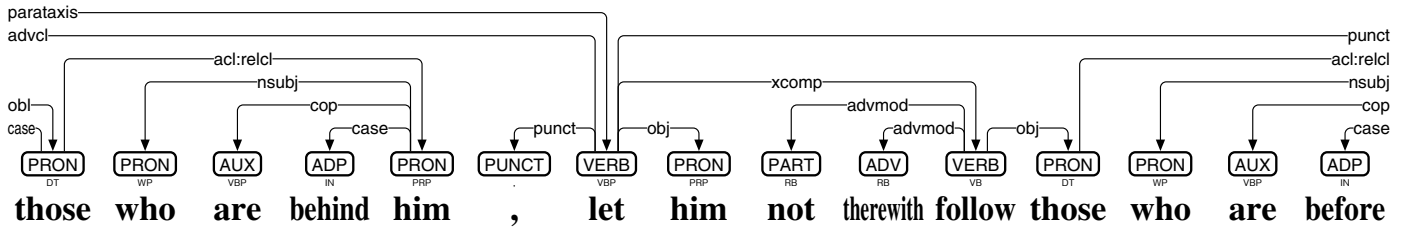

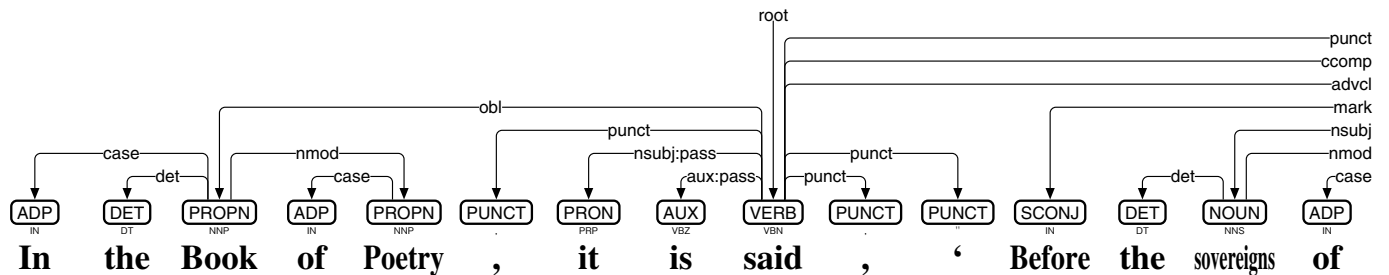
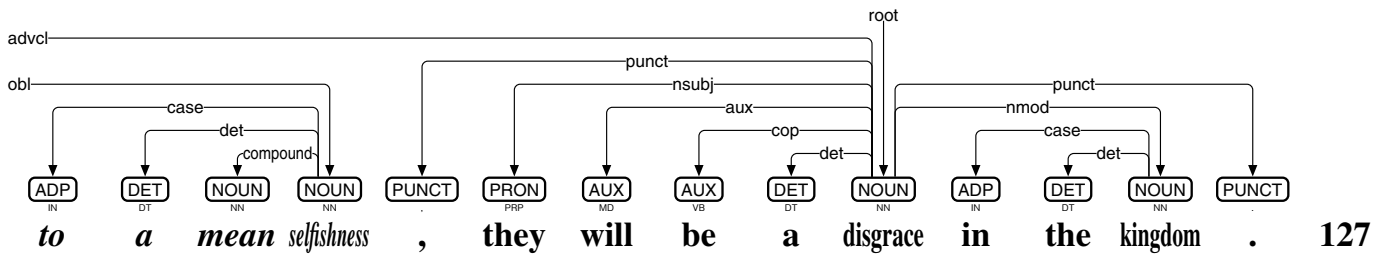
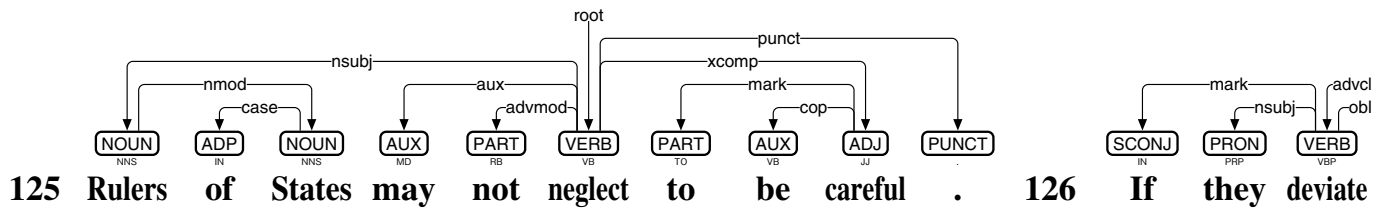
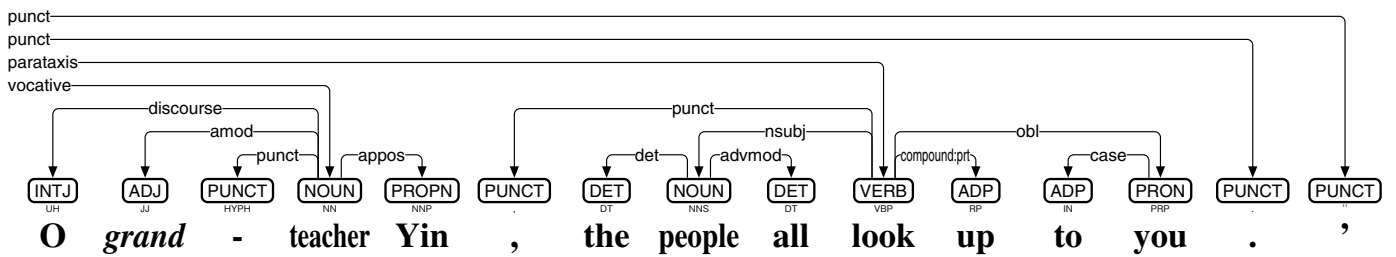
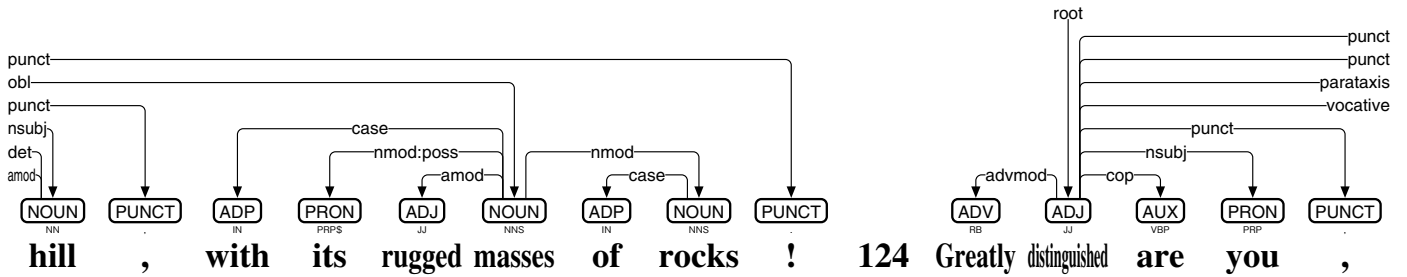
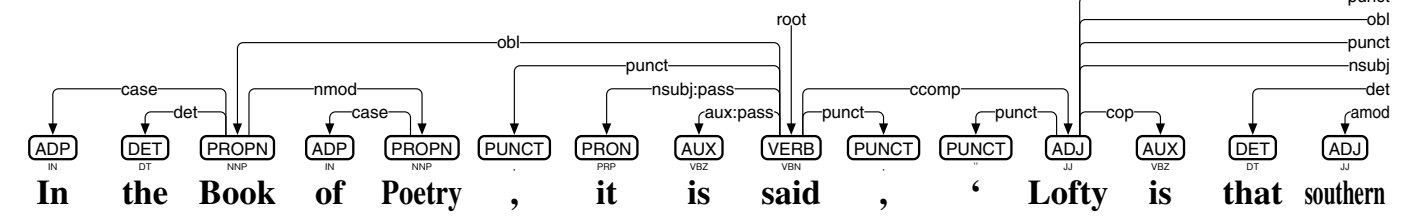
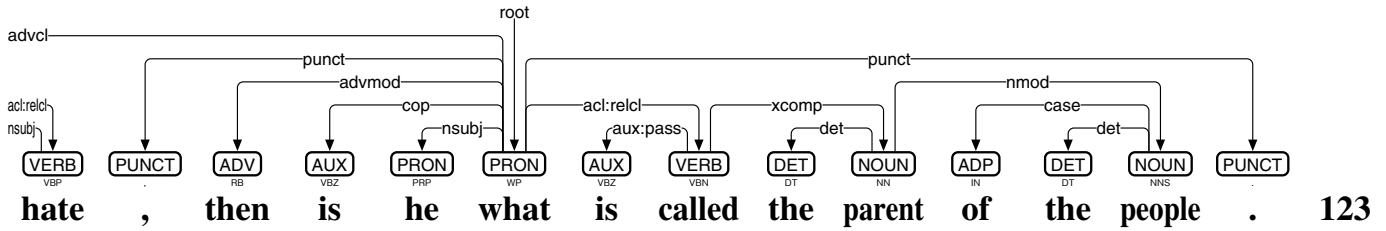

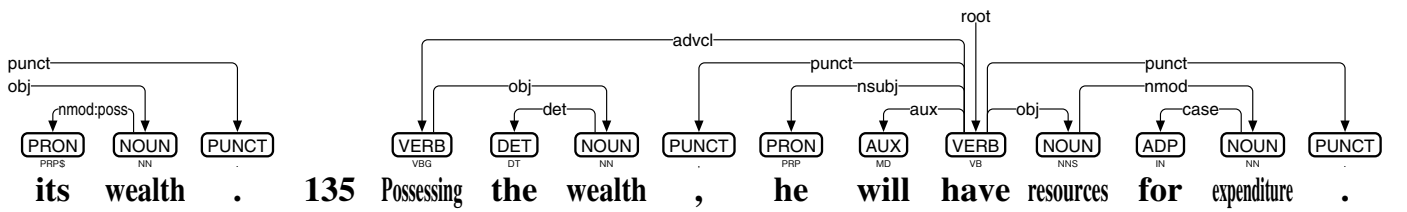
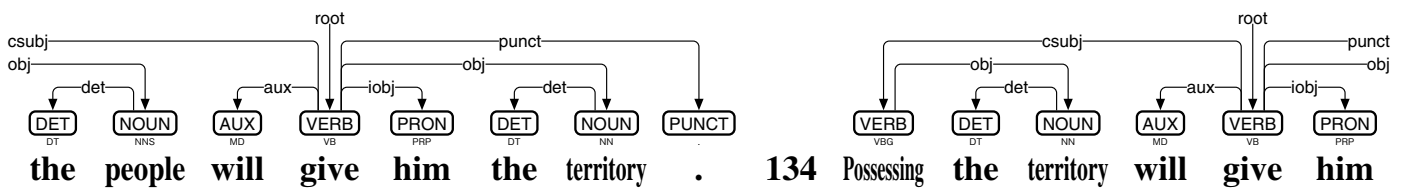
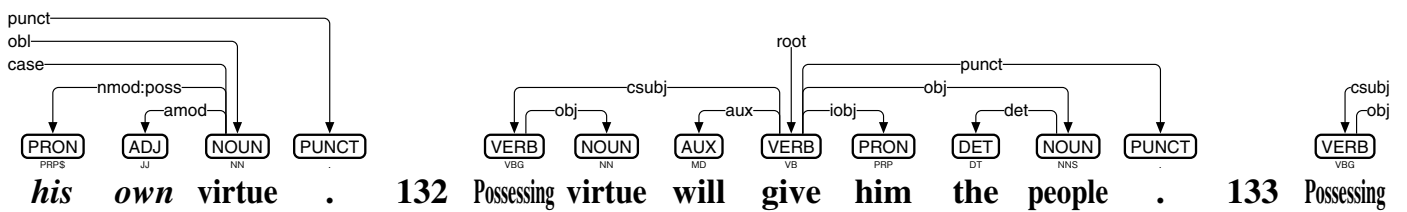
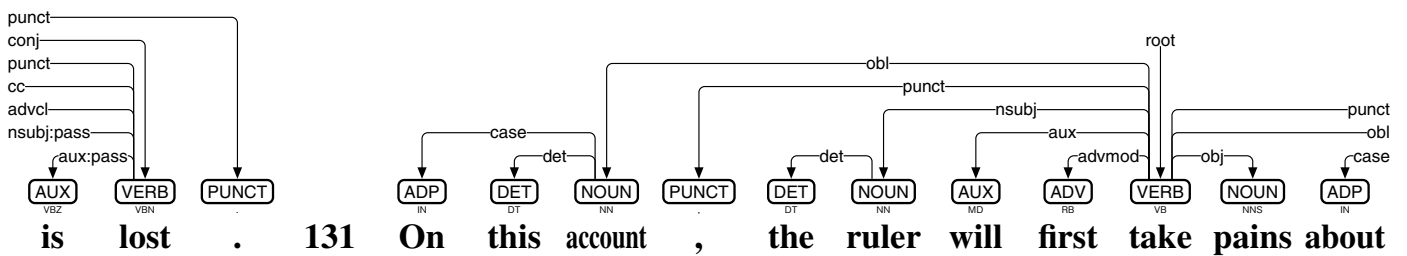
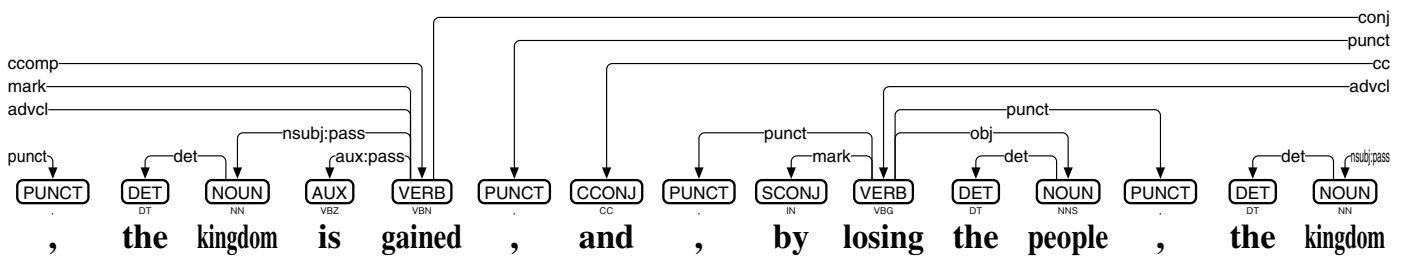
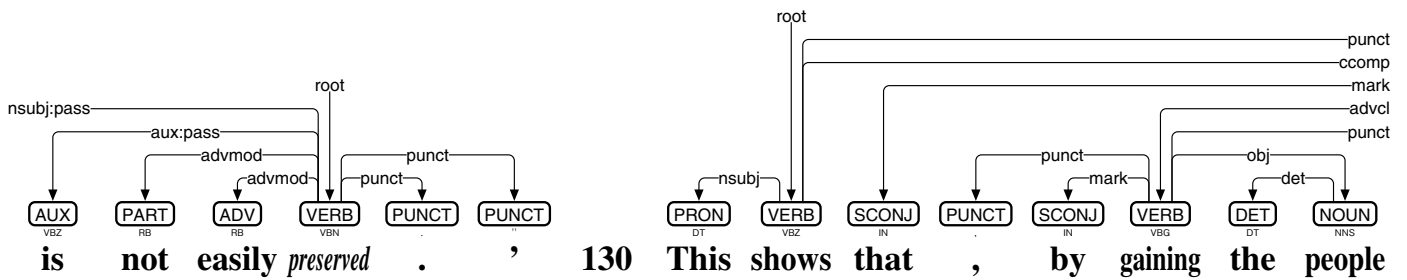
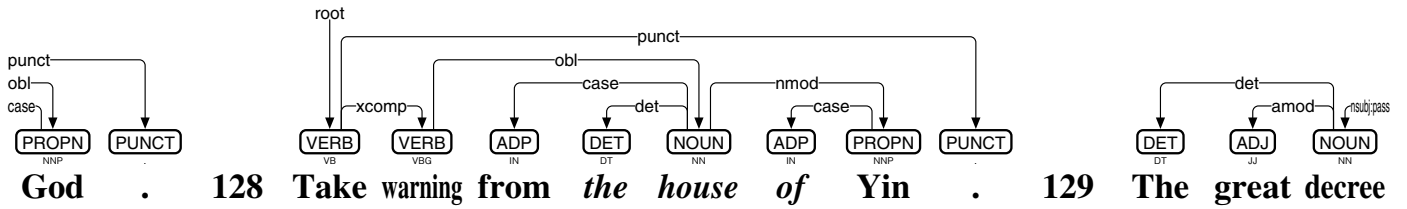
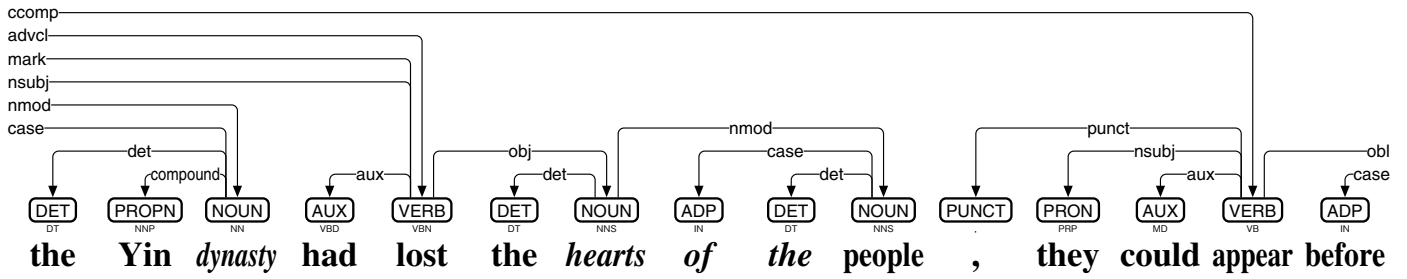

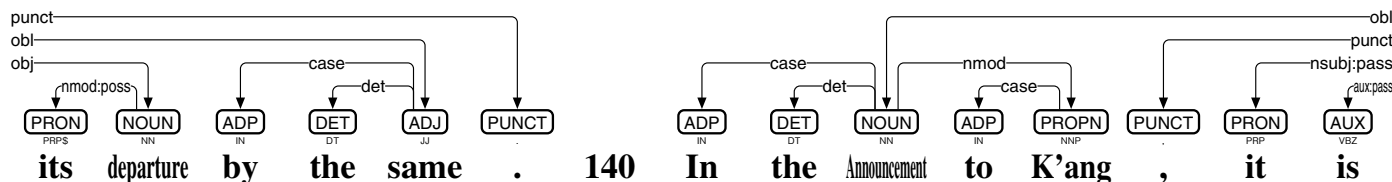
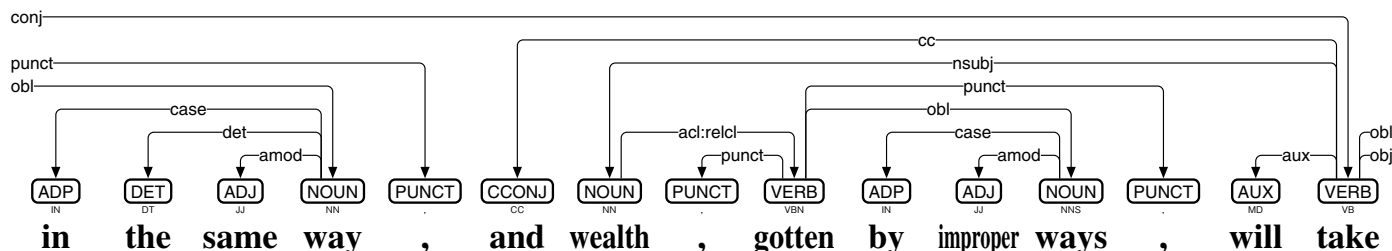
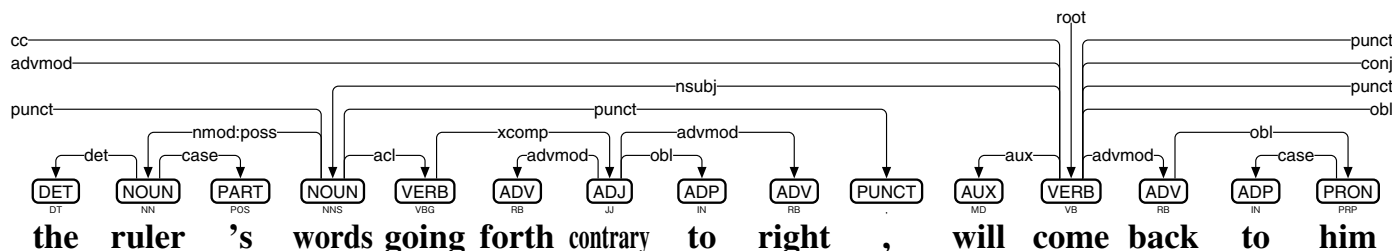
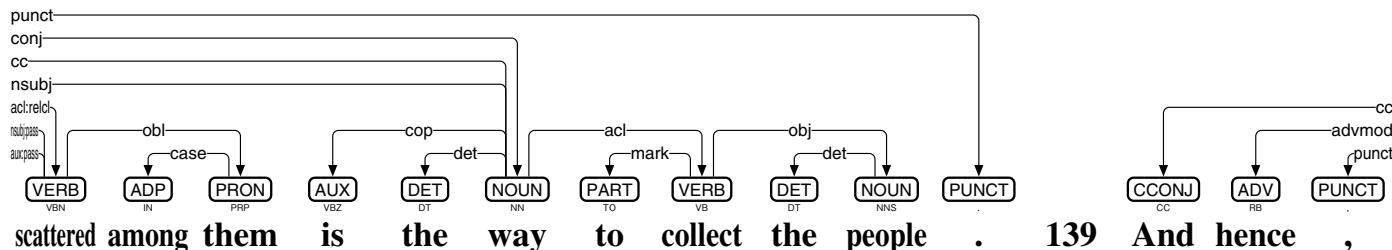
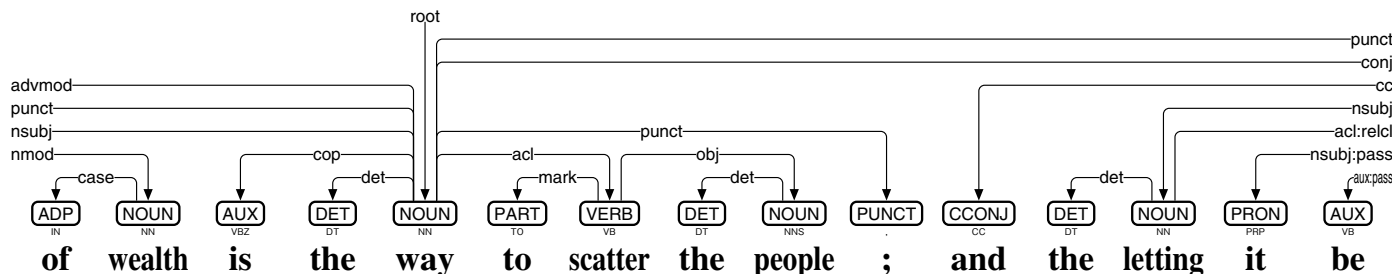
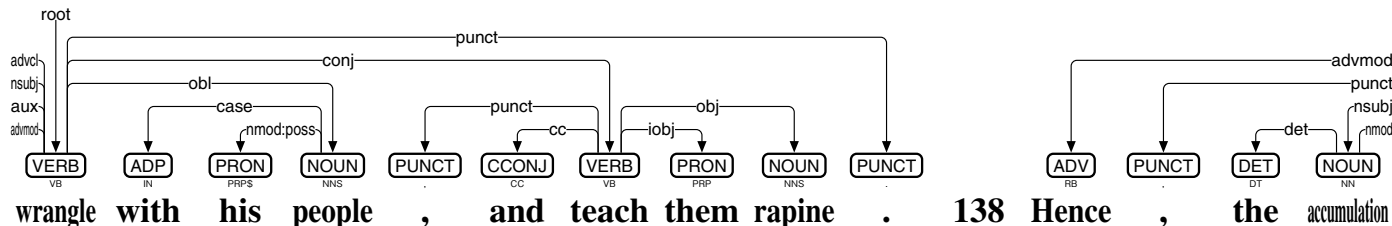
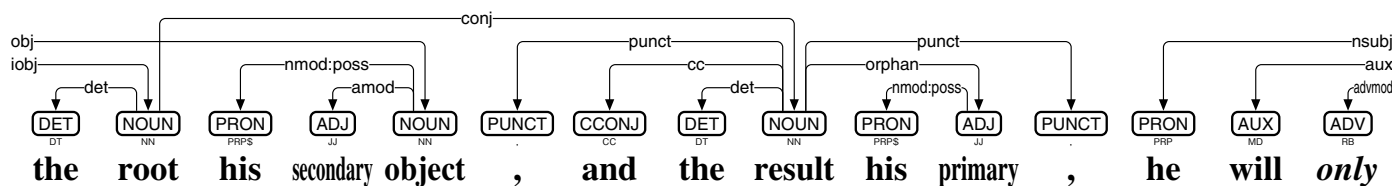
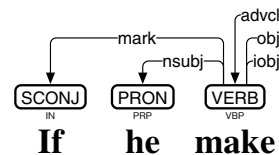
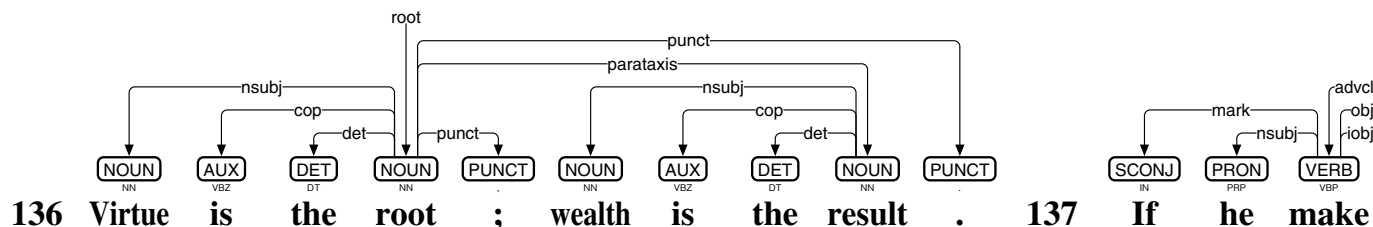

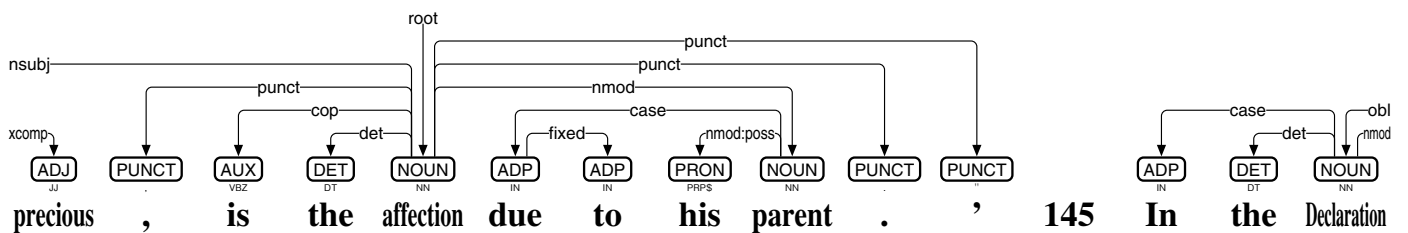
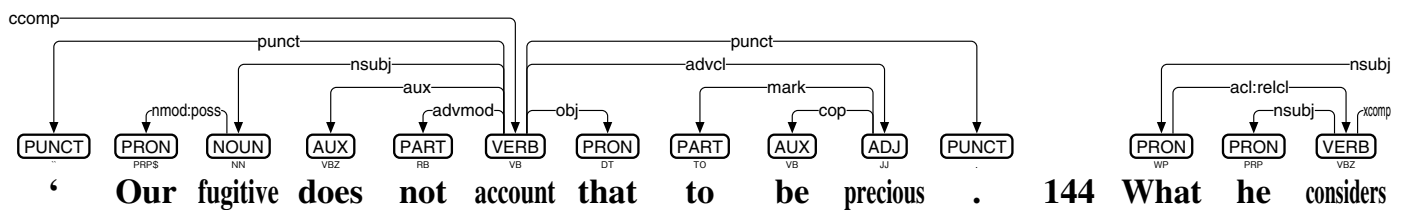
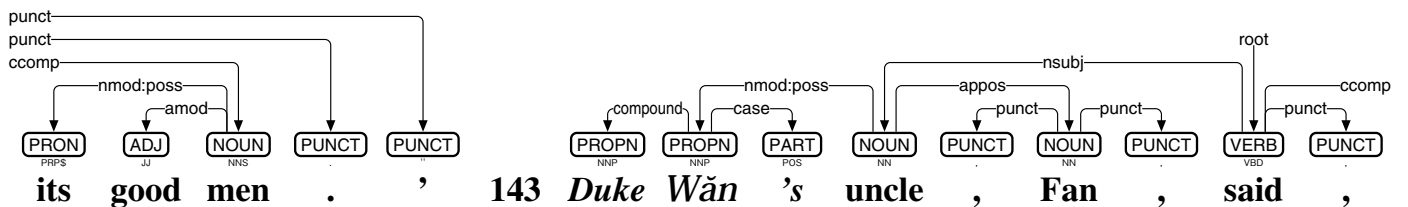
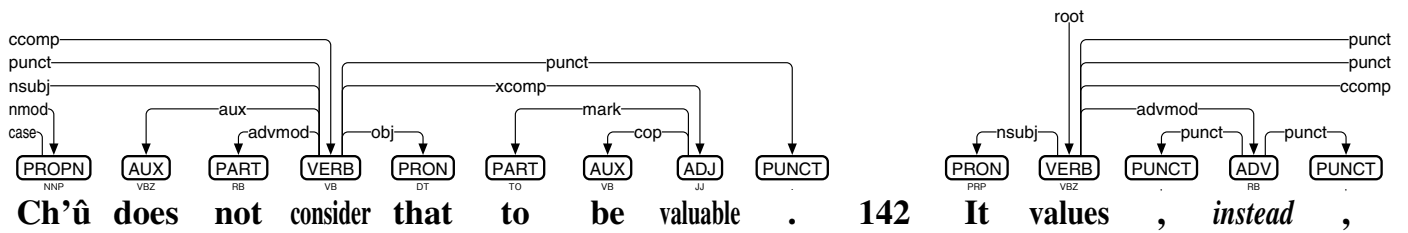
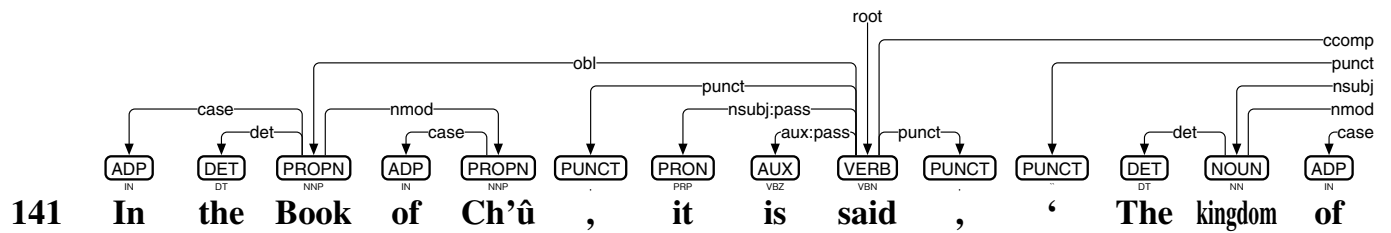
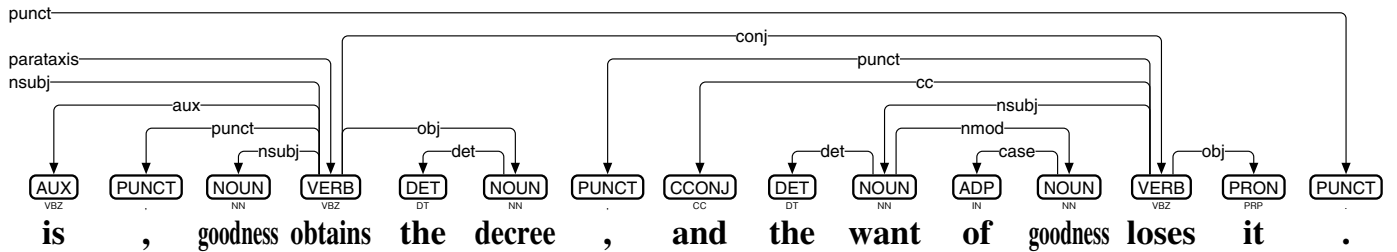
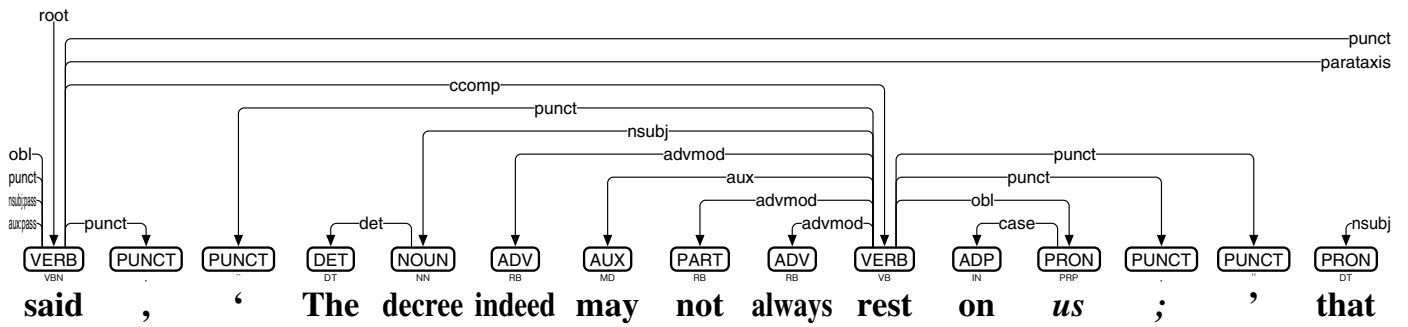

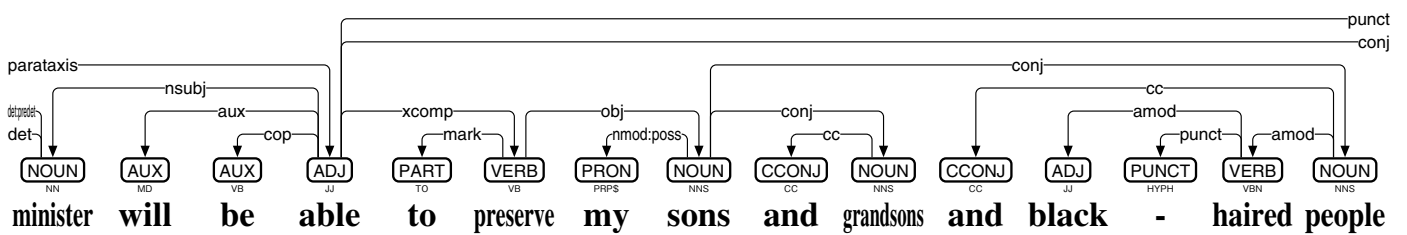
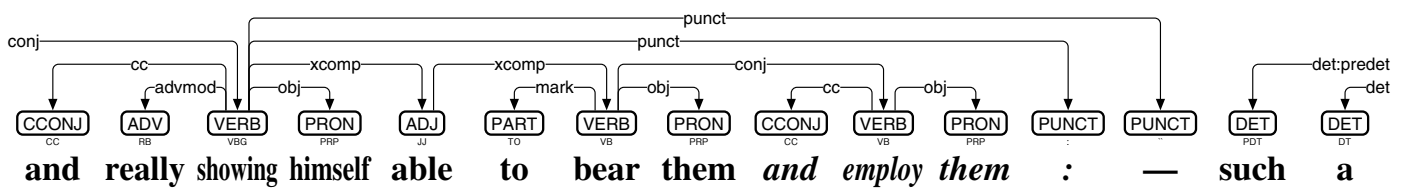
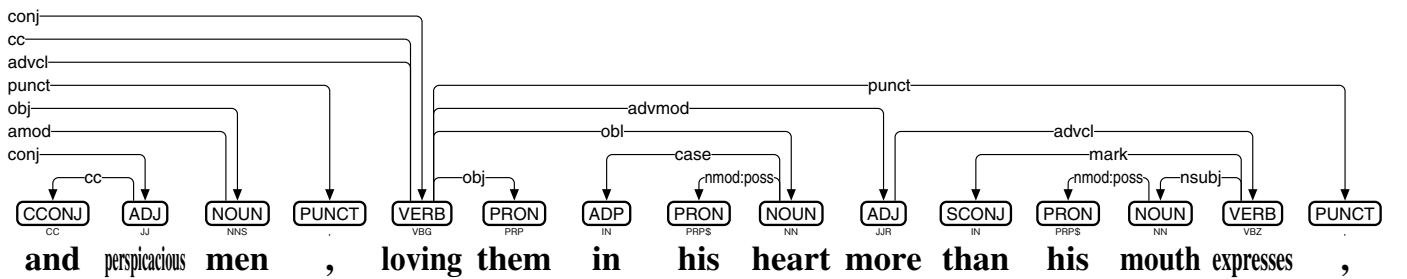
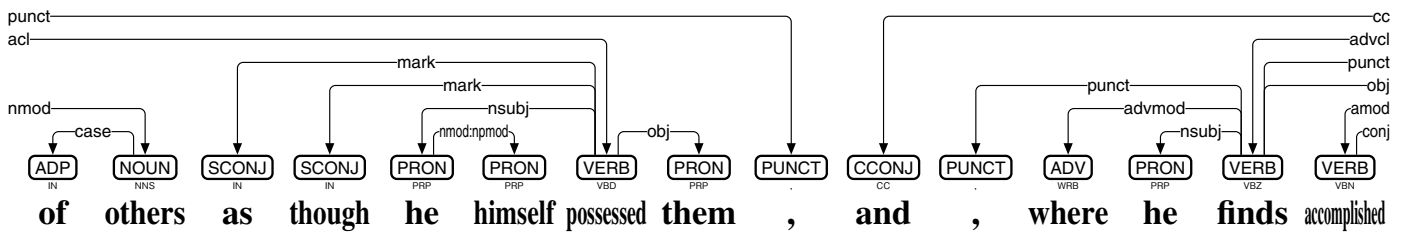
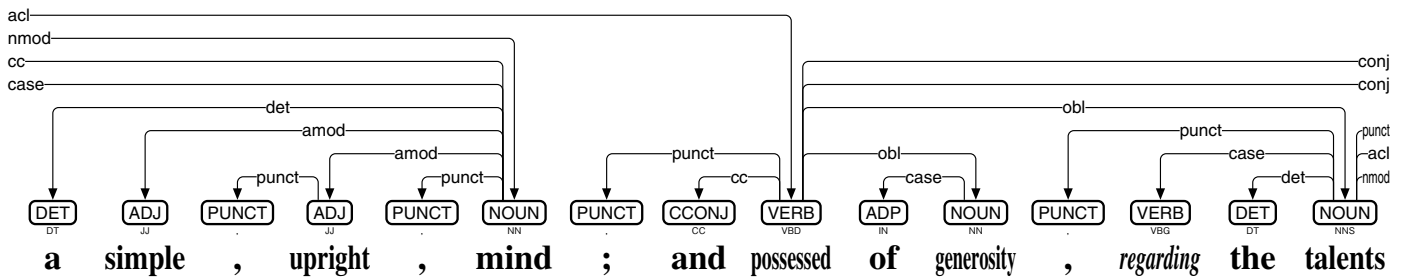
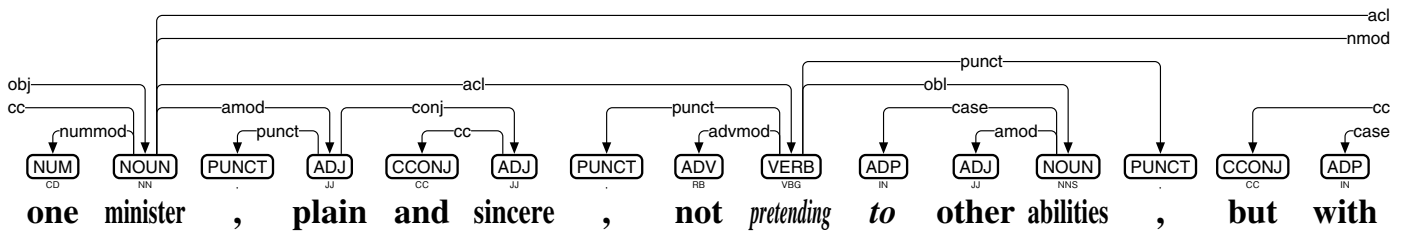
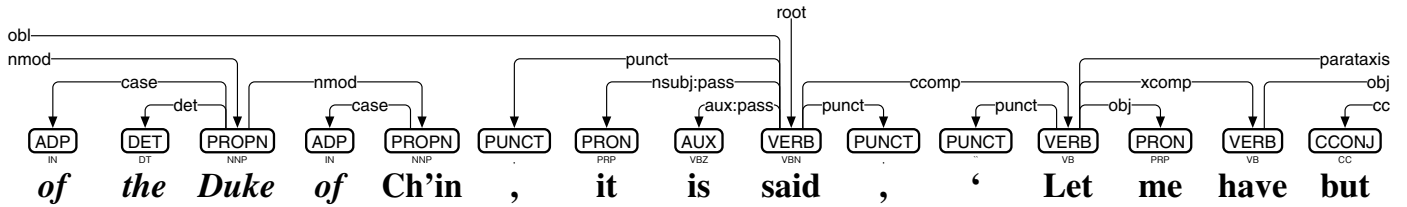

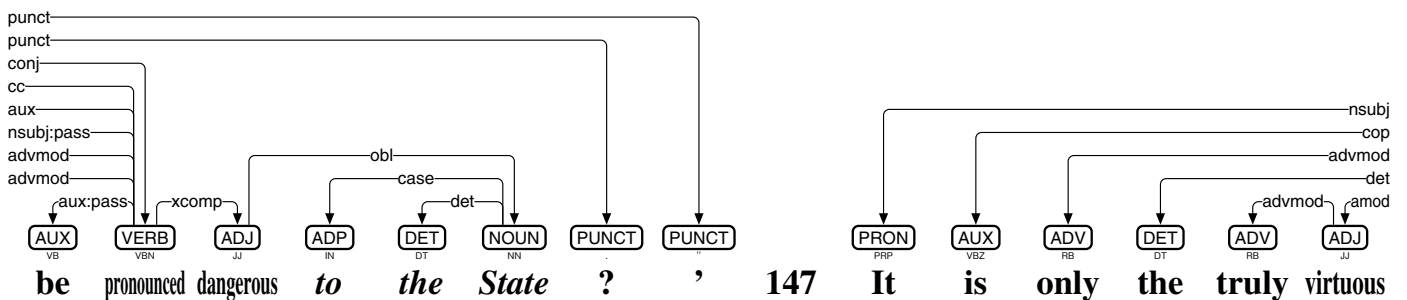
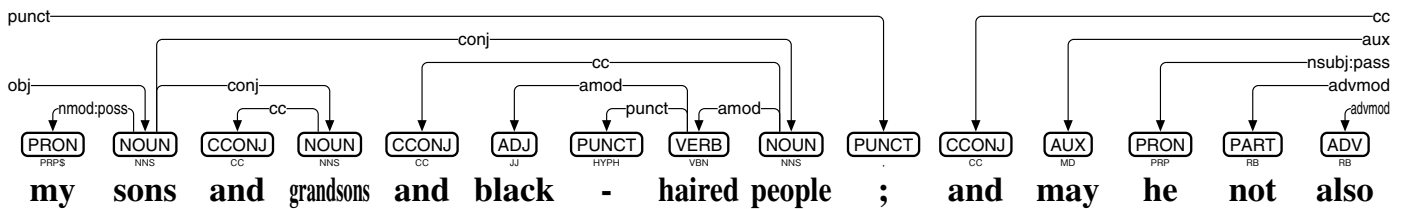
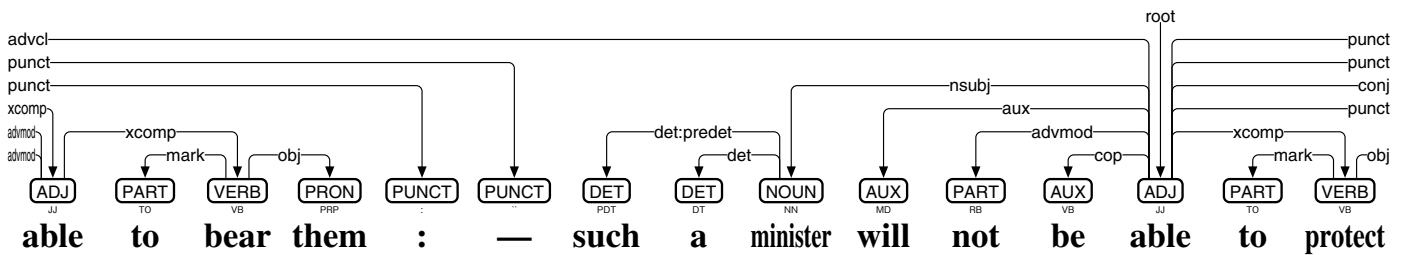
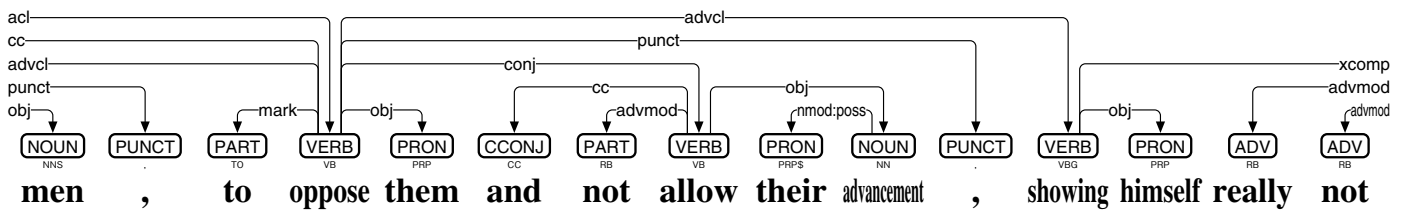
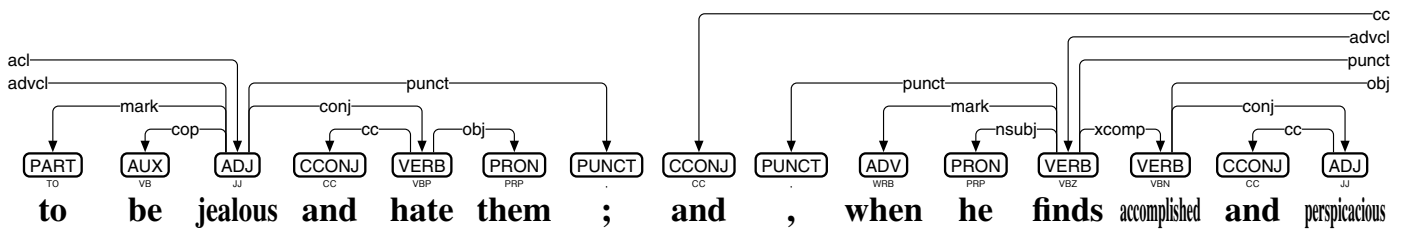
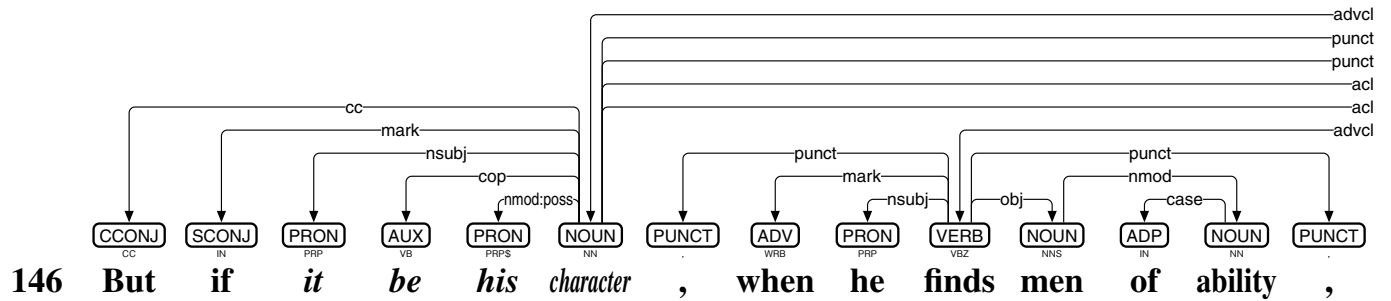
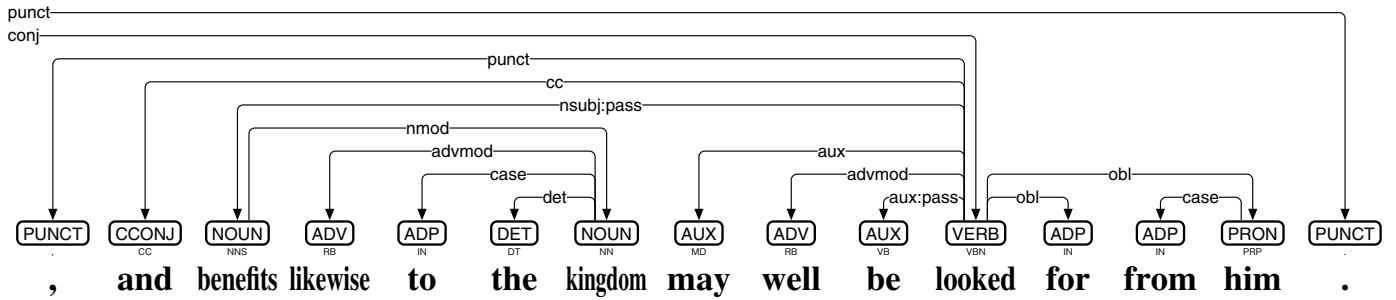

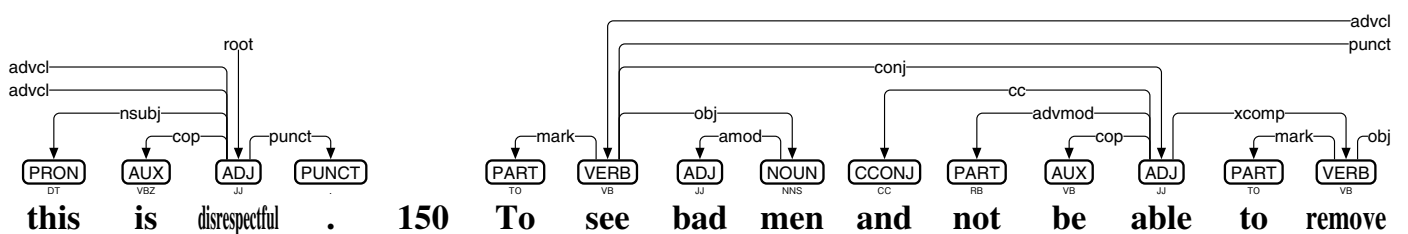
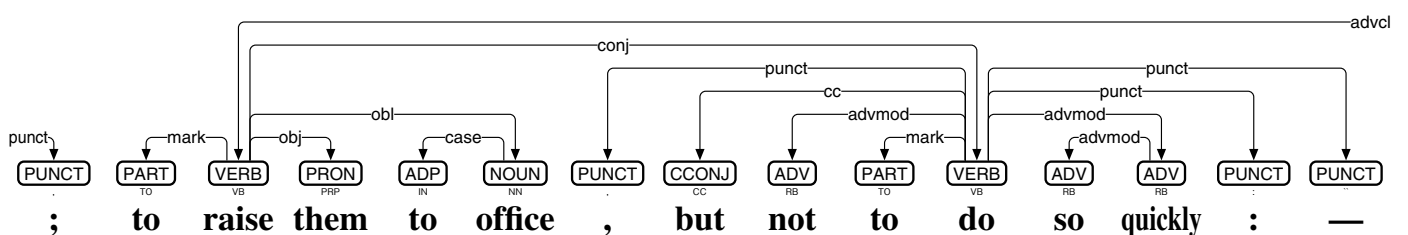
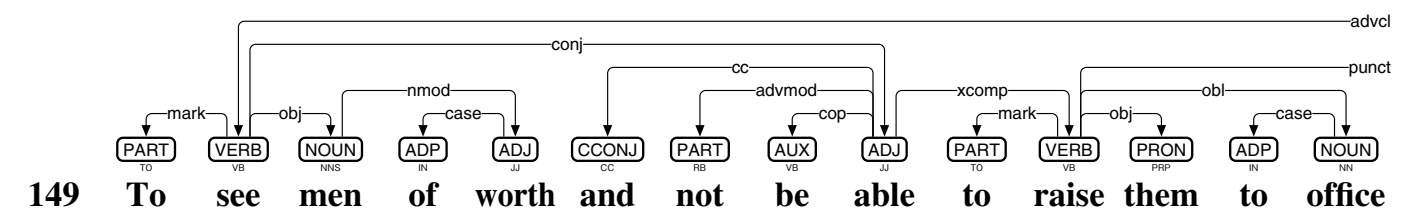
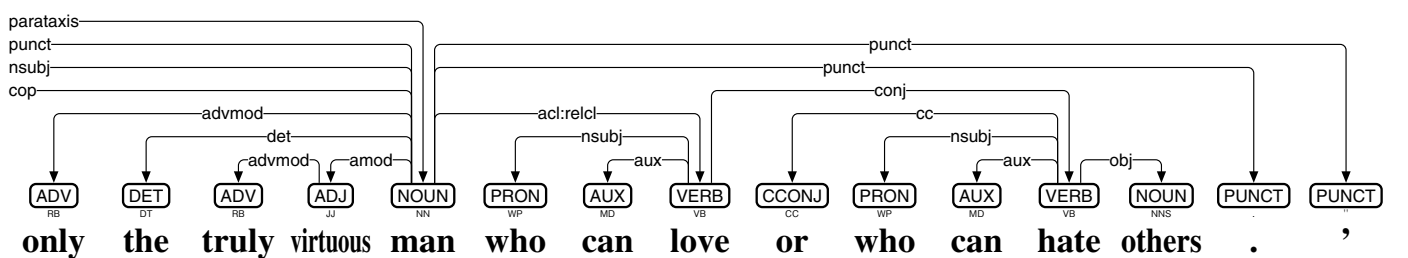
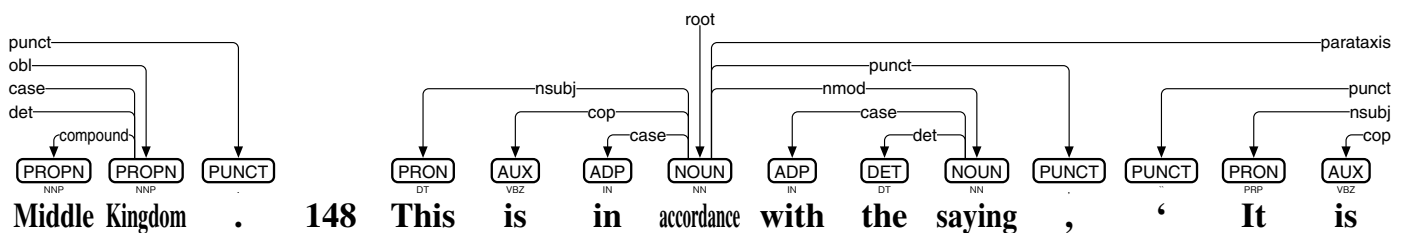
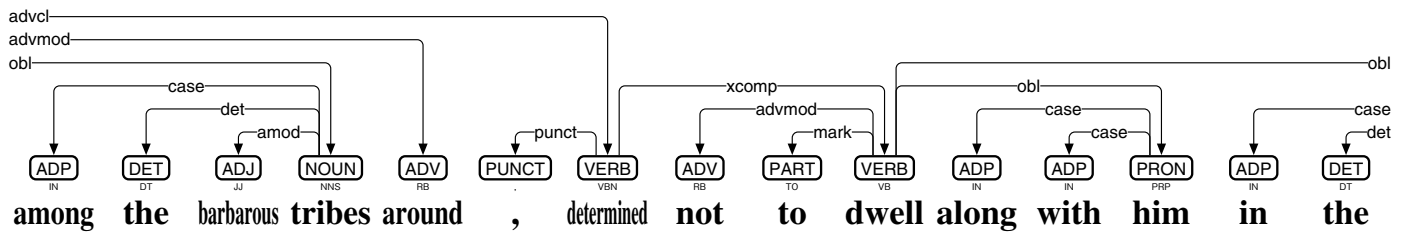
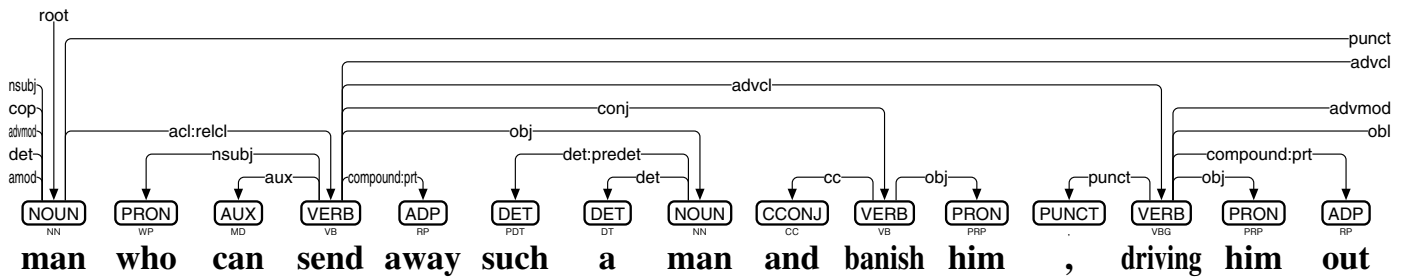

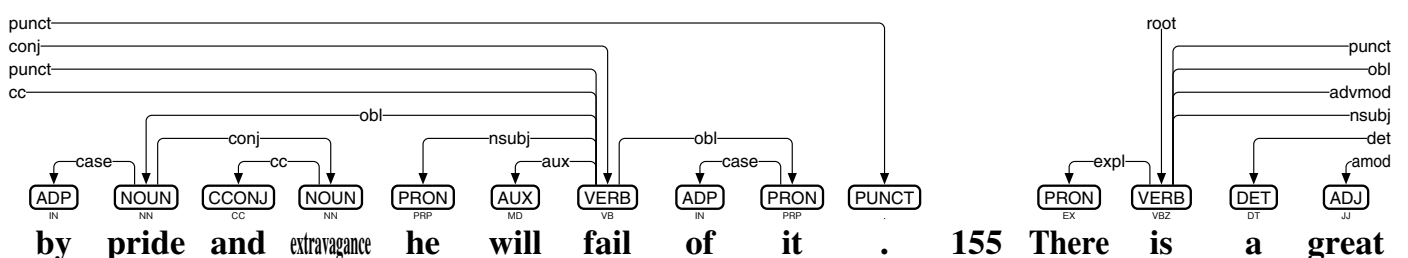
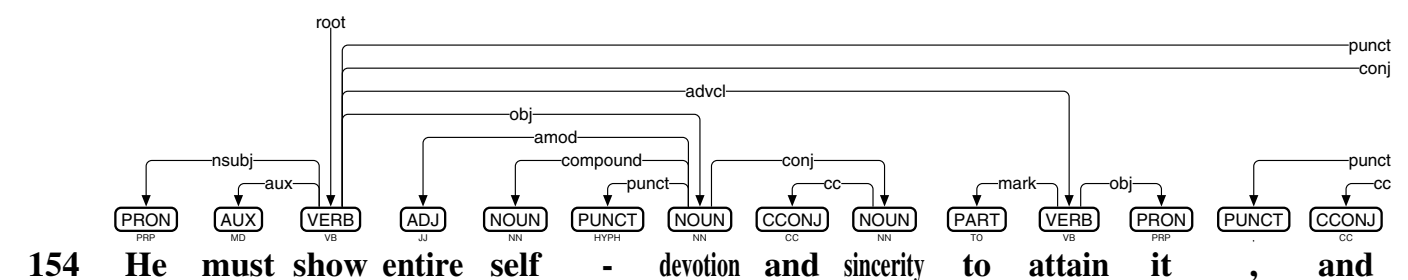
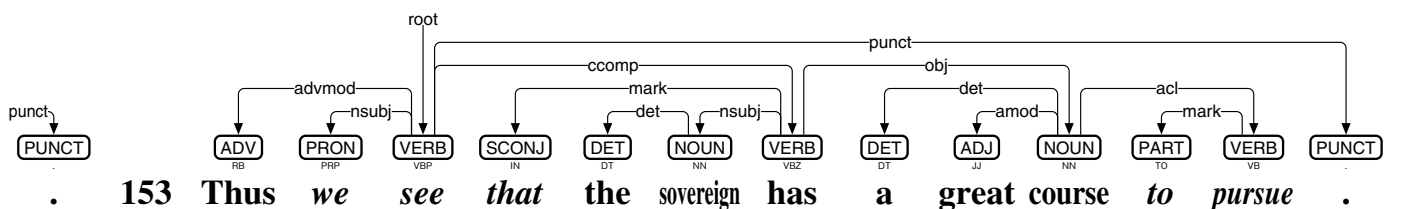
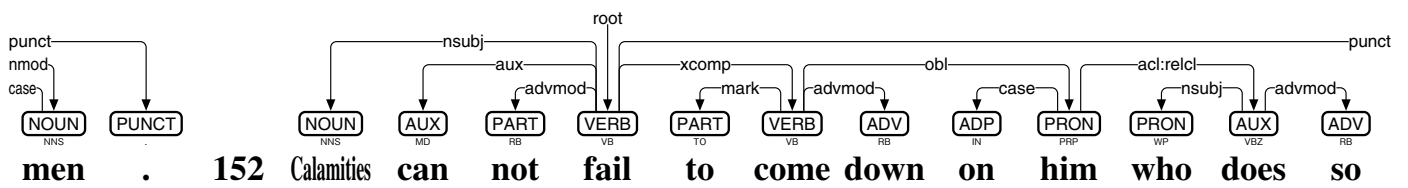
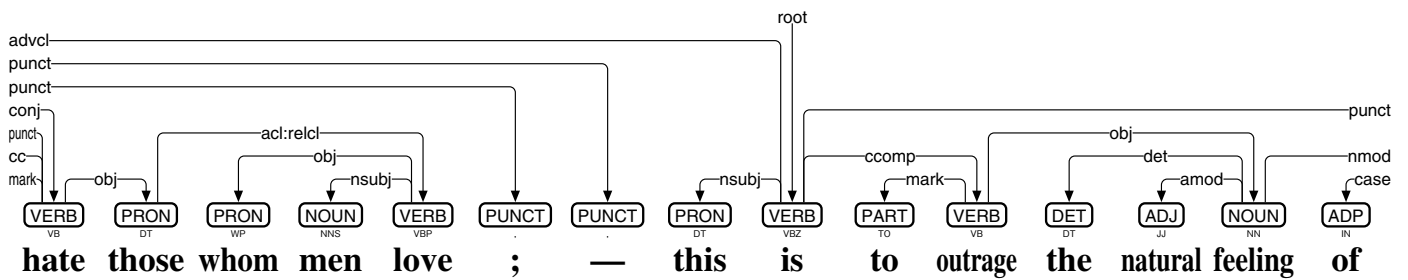
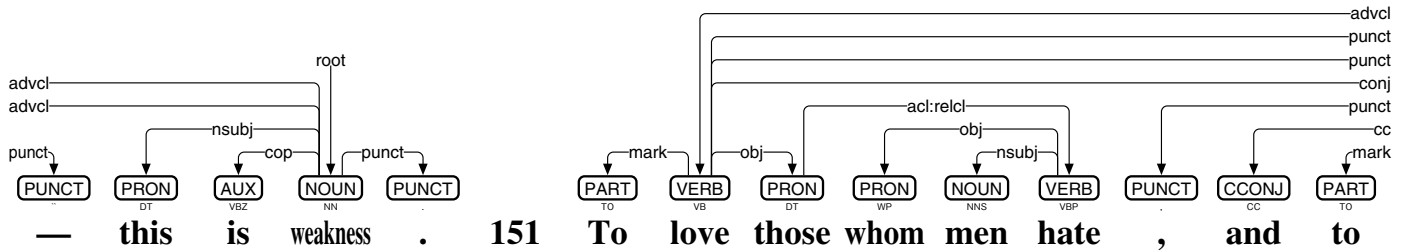
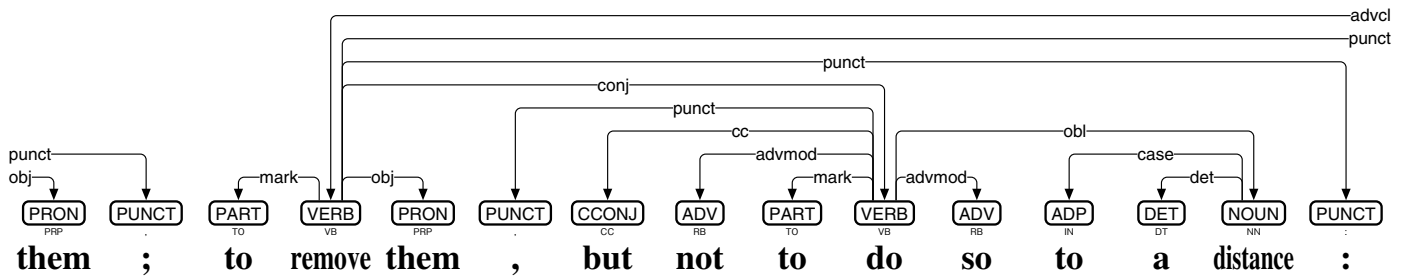

course *also* for the production of wealth . 156 Let the producers be many and

The syntax tree for this sentence shows a main clause starting with the verb 'Let' (VB) and a subject 'the producers' (NOUN NNS). The main clause is followed by a complementizer 'and' (CCONJ) and another clause 'the producers be many' (NOUN NNS, AUX VB, ADJ JJ). The first part 'course also for the production of wealth' is a prepositional phrase (ADP IN, ADV RB, ADP IN, DET DT, NOUN NN, ADP IN, NOUN NN, PUNCT) acting as an adverbial modifier (advmod) of the main clause.

the consumers few . 157 Let there be activity in the production , and economy

The syntax tree for this sentence shows a main clause starting with the verb 'Let' (VB) and a subject 'there' (PRON EX). The main clause is followed by a complementizer 'and' (CCONJ) and another clause 'the production be activity' (NOUN NN, PUNCT, CCONJ CC, NOUN NN, AUX VB, ADJ JJ). The first part 'the consumers few' is a prepositional phrase (DET DT, NOUN NNS, ADJ JJ, PUNCT) acting as an adverbial modifier (advmod) of the main clause.

in the expenditure . 158 Then the wealth will always be sufficient . 159 The

The syntax tree for this sentence shows a main clause starting with the verb 'Then' (ADV RB) and a subject 'the wealth' (DET DT, NOUN NN). The main clause is followed by a complementizer 'and' (CCONJ CC) and another clause 'the wealth will always be sufficient' (NOUN NN, PUNCT, CCONJ CC, NOUN NN, AUX MD, ADV RB, AUX VB, ADJ JJ). The first part 'in the expenditure' is a prepositional phrase (ADP IN, DET DT, NOUN NN, PUNCT) acting as an adverbial modifier (advmod) of the main clause.

virtuous ruler , by means of his wealth , makes himself more distinguished . 160

The syntax tree for this sentence shows a main clause starting with the verb 'makes' (VBZ) and a subject 'virtuous ruler' (ADJ JJ, NOUN NN). The main clause is followed by a complementizer 'and' (CCONJ CC) and another clause 'by means of his wealth' (ADP IN, NOUN NNS, ADP IN, PRON PRPS, NOUN NN, PUNCT). The first part 'virtuous ruler' is a prepositional phrase (ADJ JJ, NOUN NN, PUNCT) acting as an adverbial modifier (advmod) of the main clause.

The vicious ruler accumulates wealth , at the expense of his life . 161 Never

The syntax tree for this sentence shows a main clause starting with the verb 'accumulates' (VBZ) and a subject 'The vicious ruler' (DET DT, ADJ JJ, NOUN NN). The main clause is followed by a complementizer 'and' (CCONJ CC) and another clause 'at the expense of his life' (ADP IN, DET DT, NOUN NN, ADP IN, PRON PRPS, NOUN NN, PUNCT). The first part 'The vicious ruler' is a prepositional phrase (DET DT, ADJ JJ, NOUN NN, PUNCT) acting as an adverbial modifier (advmod) of the main clause.

has there been a case of the sovereign loving benevolence , and the people not

The syntax tree for this sentence shows a main clause starting with the verb 'has there been' (AUX VBZ, PRON EX, VERB VBN) and a subject 'a case of the sovereign' (DET DT, NOUN NN, ADP IN, DET DT, NOUN NN). The main clause is followed by a complementizer 'and' (CCONJ CC) and another clause 'the people not' (NOUN NNS, ADV RB). The first part 'has there been a case of the sovereign' is a prepositional phrase (AUX VBZ, PRON EX, VERB VBN, DET DT, NOUN NN, ADP IN, DET DT, NOUN NN, PUNCT) acting as an adverbial modifier (advmod) of the main clause.

loving righteousness . 162 Never has there been a case where the people have loved

The syntax tree for this sentence shows a main clause starting with the verb 'Never has there been' (ADV RB, AUX VBZ, PRON EX, VERB VBN) and a subject 'a case where the people' (DET DT, NOUN NN, ADP IN, DET DT, NOUN NN). The main clause is followed by a complementizer 'and' (CCONJ CC) and another clause 'the people have loved' (NOUN NNS, AUX VBP, VERB VBN). The first part 'loving righteousness' is a prepositional phrase (VERB VBG, NOUN NN, PUNCT) acting as an adverbial modifier (advmod) of the main clause.

righteousness , and the affairs of the sovereign have not been carried to completion .

The syntax tree for this sentence shows a main clause starting with the verb 'have not been carried' (AUX VBP, PART RB, AUX VBN, VERB VBN) and a subject 'the affairs of the sovereign' (DET DT, NOUN NNS, ADP IN, DET DT, NOUN NN). The main clause is followed by a complementizer 'and' (CCONJ CC) and another clause 'to completion' (ADP IN, NOUN NN, PUNCT). The first part 'righteousness' is a prepositional phrase (NOUN NN, PUNCT) acting as an adverbial modifier (advmod) of the main clause.

